

# STABLE

## FORT LARAMIE NATIONAL MONUMENT WYOMING

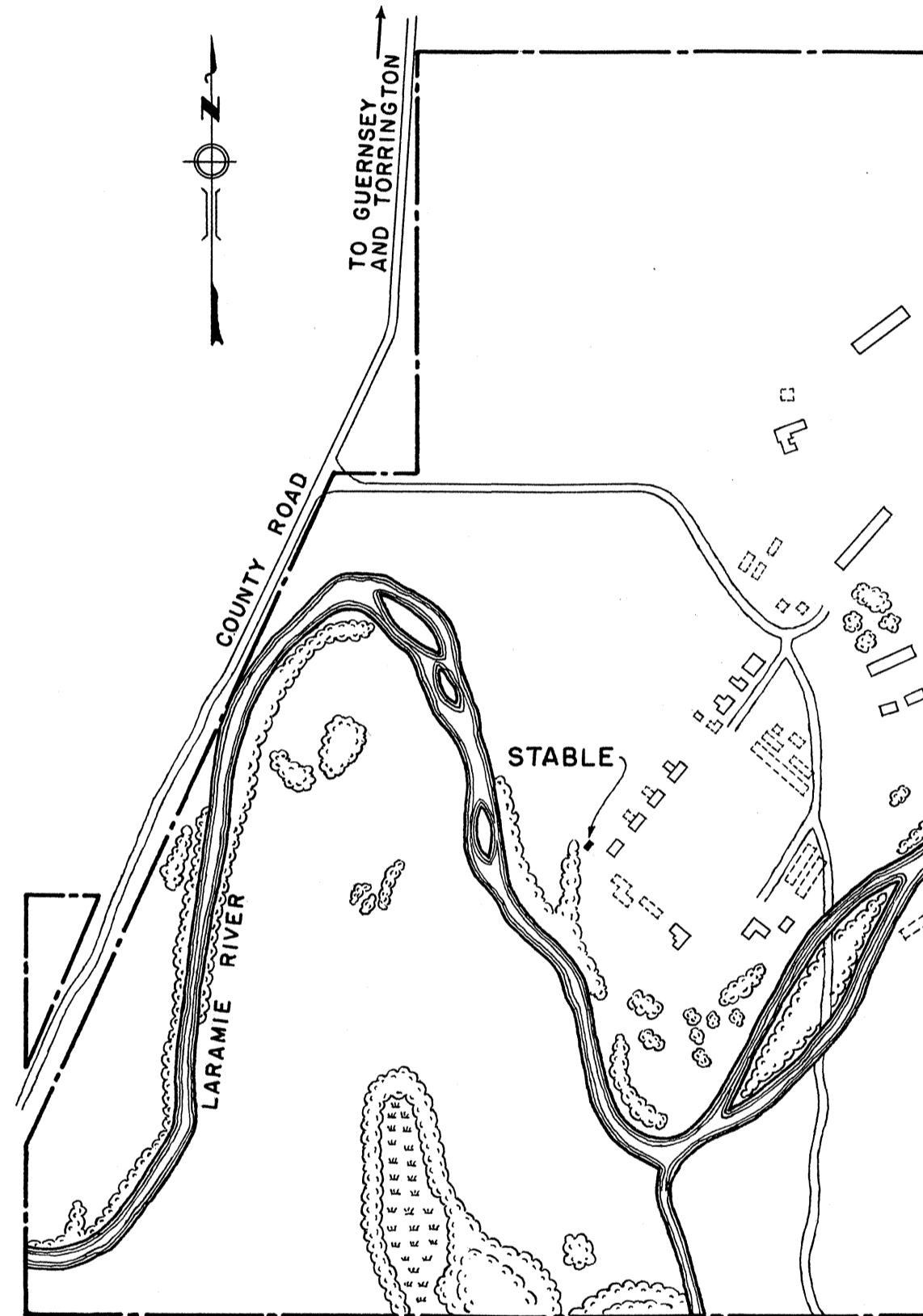

MAP OF FORT LARAMIE NATIONAL MONUMENT  
SHOWING LOCATION

ERECTED ABOUT 1881  
DESIGNED & BUILT BY  
U. S. ARMY ENGINEERS

HISTORIC AMERICAN BUILDINGS SURVEY  
U. S. DEPARTMENT OF THE INTERIOR  
NATIONAL PARK SERVICE  
BRANCH OF PLANS AND DESIGN

MEASURED: MAY 1942

DRAWN: JULY 1942

MEASUREMENTS CHECKED:

DRAWINGS APPROVED: *John Williams* DISTRICT OFFICER.

DRAWINGS APPROVED: *L. E. Wilkie* CHIEF ARCHITECT.

ACCEPTED FOR LIBRARY OF CONGRESS:

COLORADO DIST. WYOMING AREA  
JOHN GAW MEEM - DIST. OFFICER  
SUNMOUNT, SANTA FE, NEW MEXICO  
FIELD PARTY  
WILLIAM I. WILLIAMS-ASST. ARCHT.  
LESLIE E. WILKIE - ASST. ARCHT.

SURVEY NO.  
WYO-12  
SHEET 1-1

INDEX NO.  
WYO.  
12-

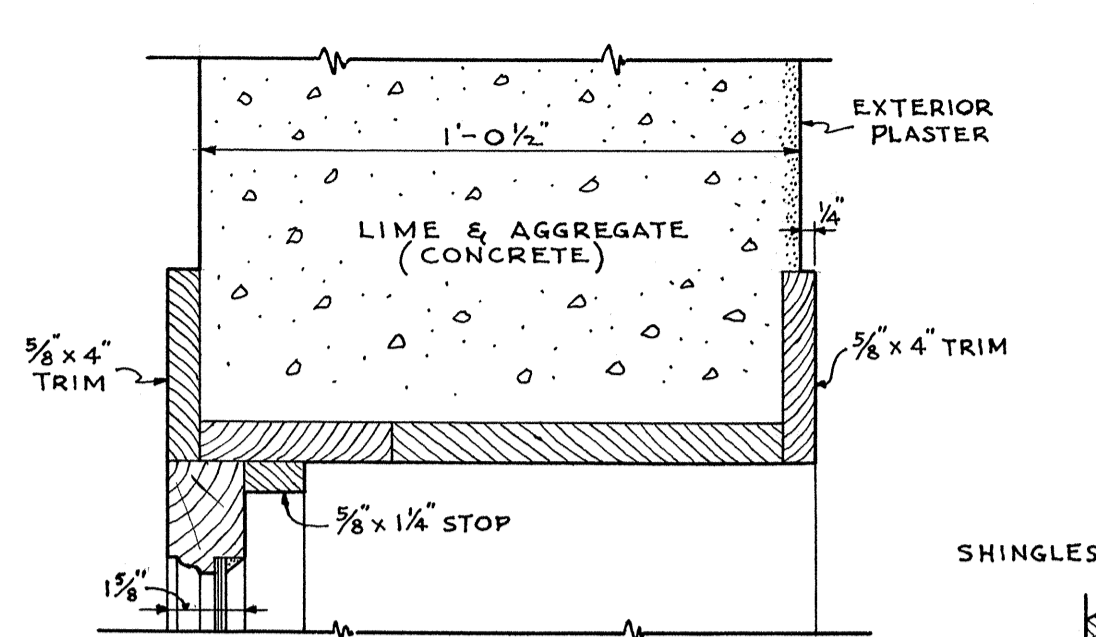

HEAD  
JAMB & SILL SIMILAR  
WINDOW DETAILS  
SCALE 3"=1'-0"

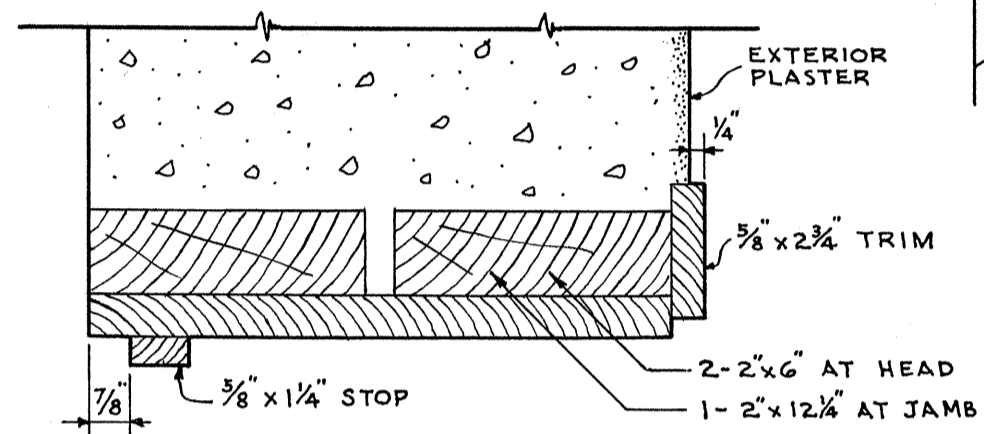

HEAD  
JAMB SIMILAR  
SILL MISSING  
DOOR DETAIL  
SCALE 3"=1'-0"

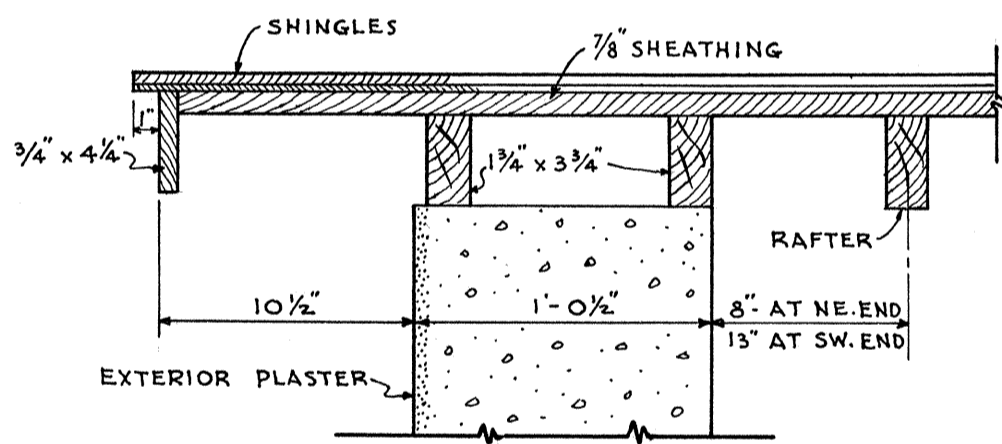

DETAIL OF RAKE  
SCALE 1 1/2"=1'-0"

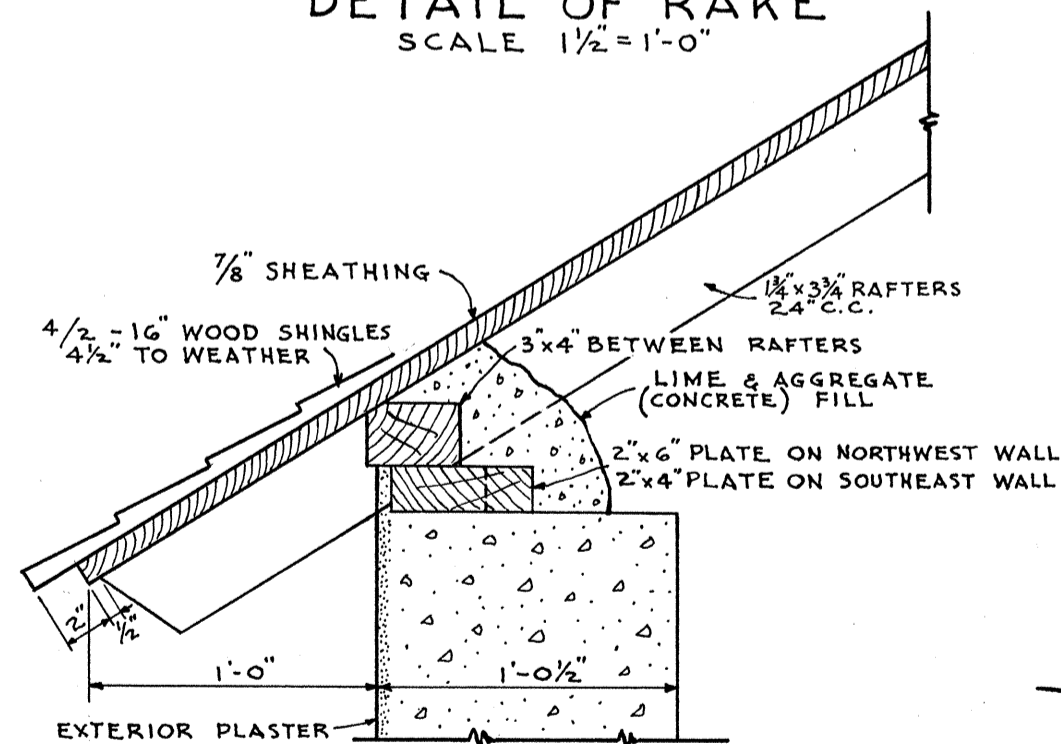

DETAIL OF EAVES  
SCALE 1 1/2"=1'-0"

LESLIE E. WILKIE - DEL.

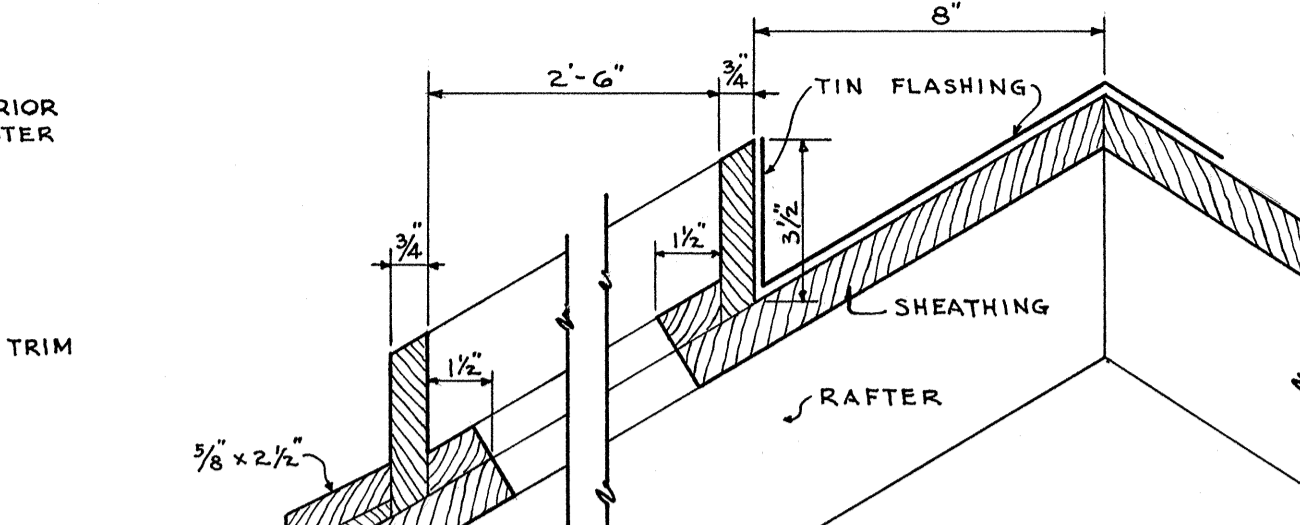

SECTION "B"

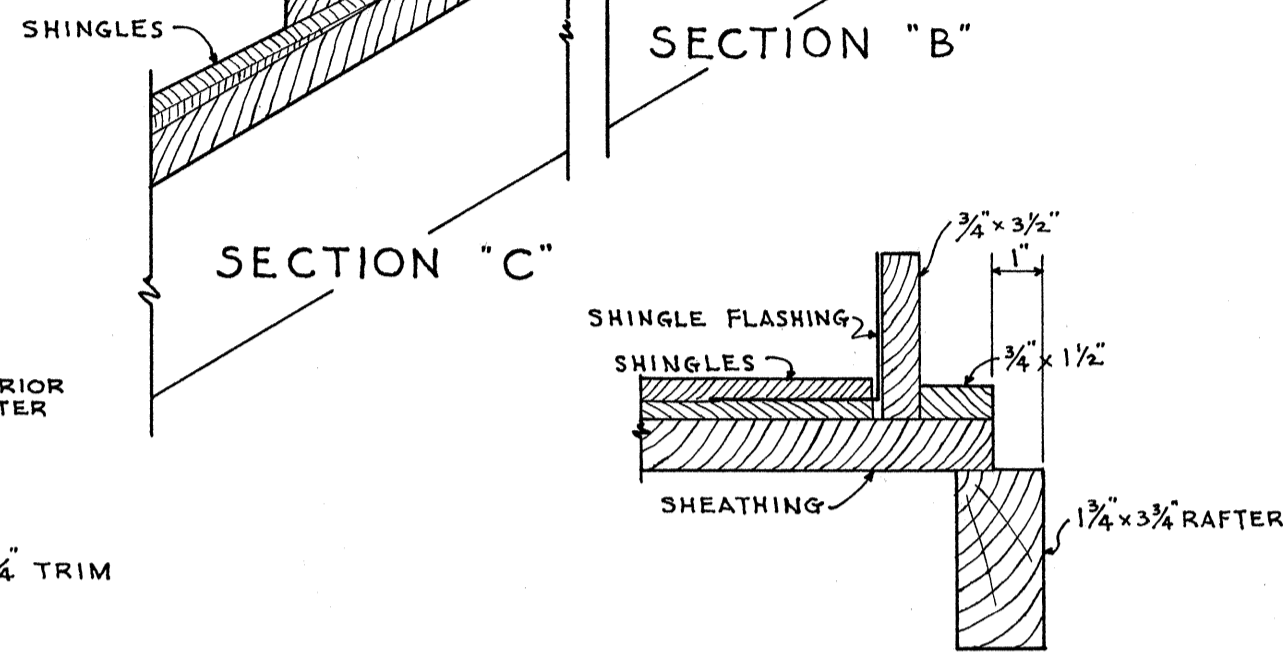

SECTION "C"

SECTION "D"

DETAILS OF OPENING IN ROOF  
SCALE 3"=1'-0"

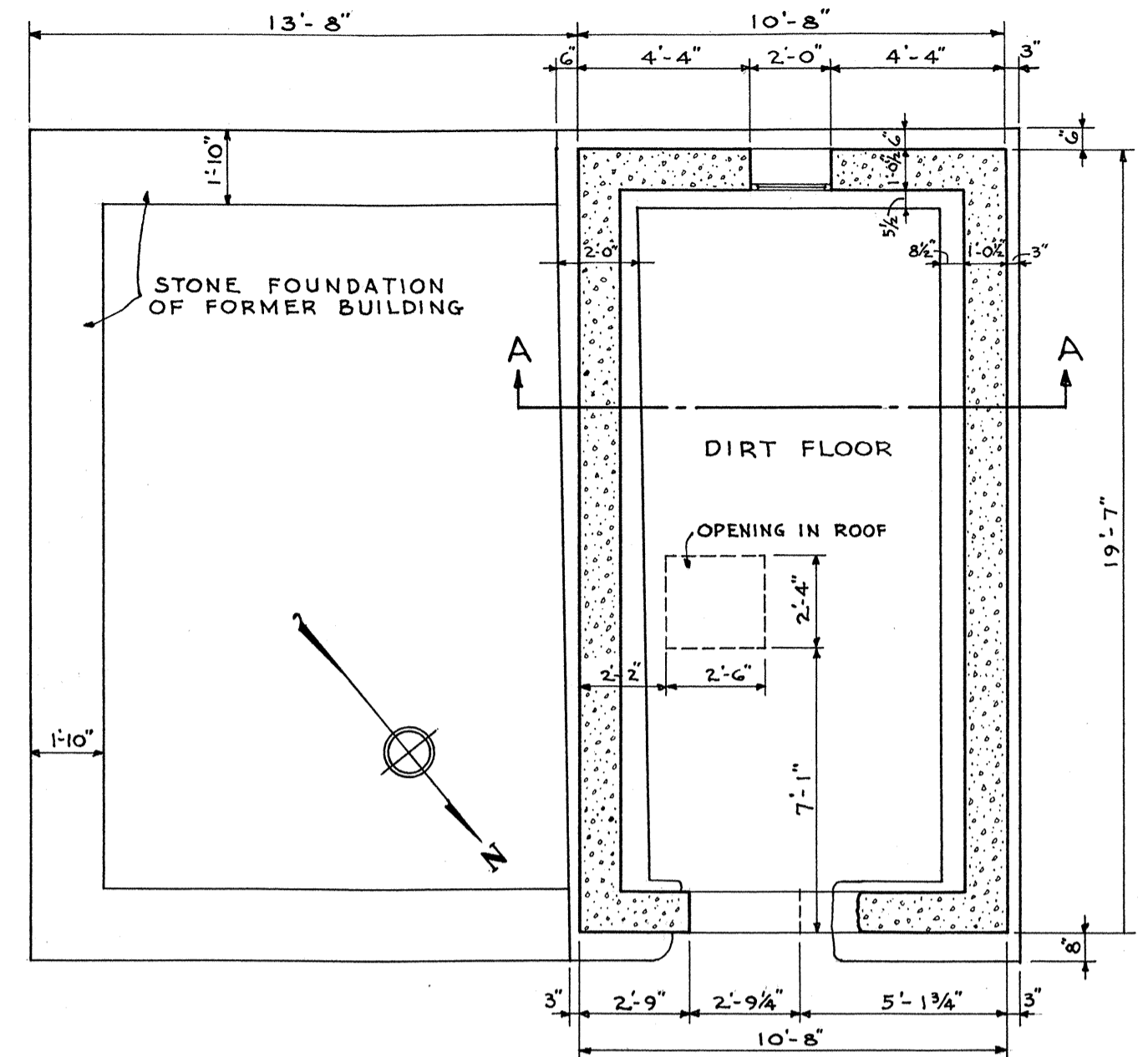

FLOOR PLAN  
SCALE 1/4"=1'-0"

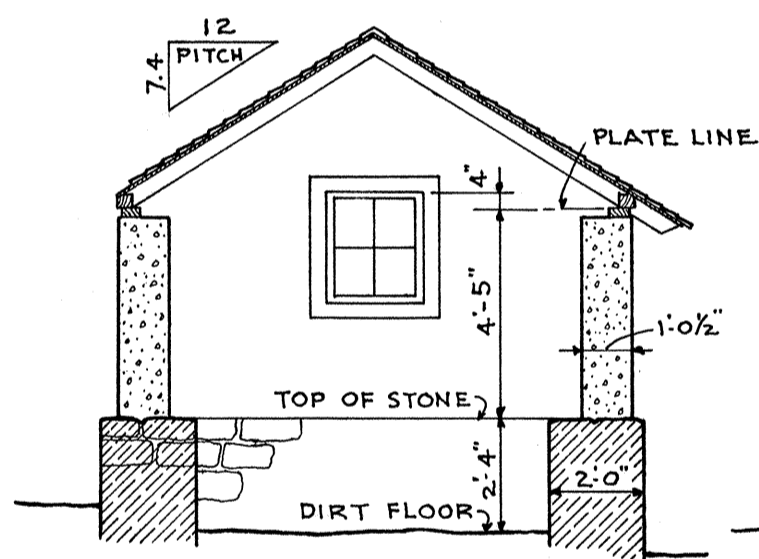

SECTION "A-A"

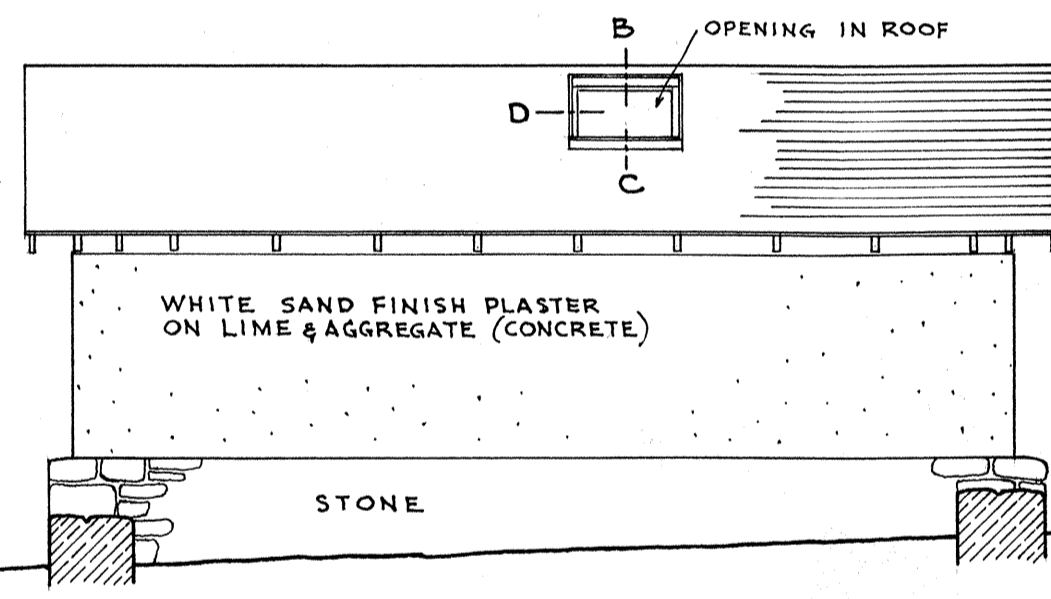

SOUTHEAST ELEVATION  
SCALE 1/4"=1'-0"

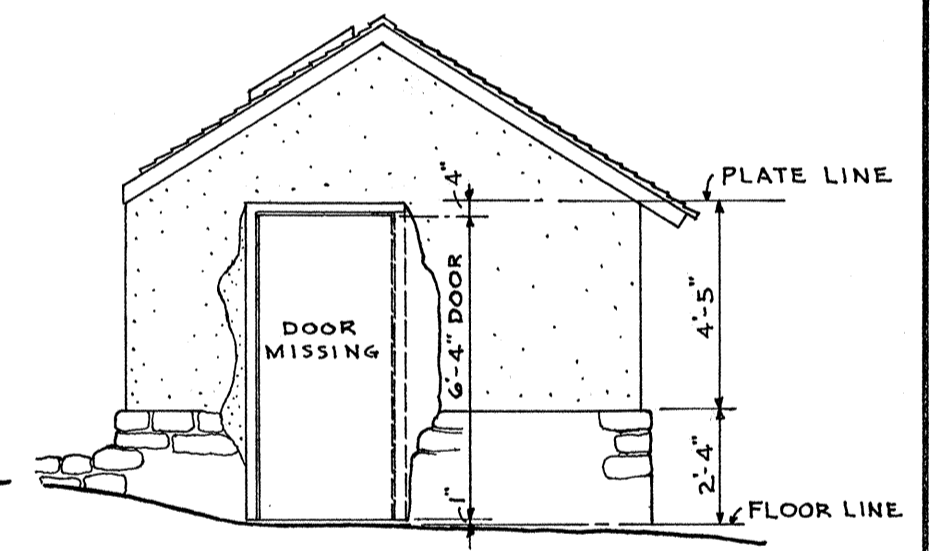

NORTHEAST ELEVATION

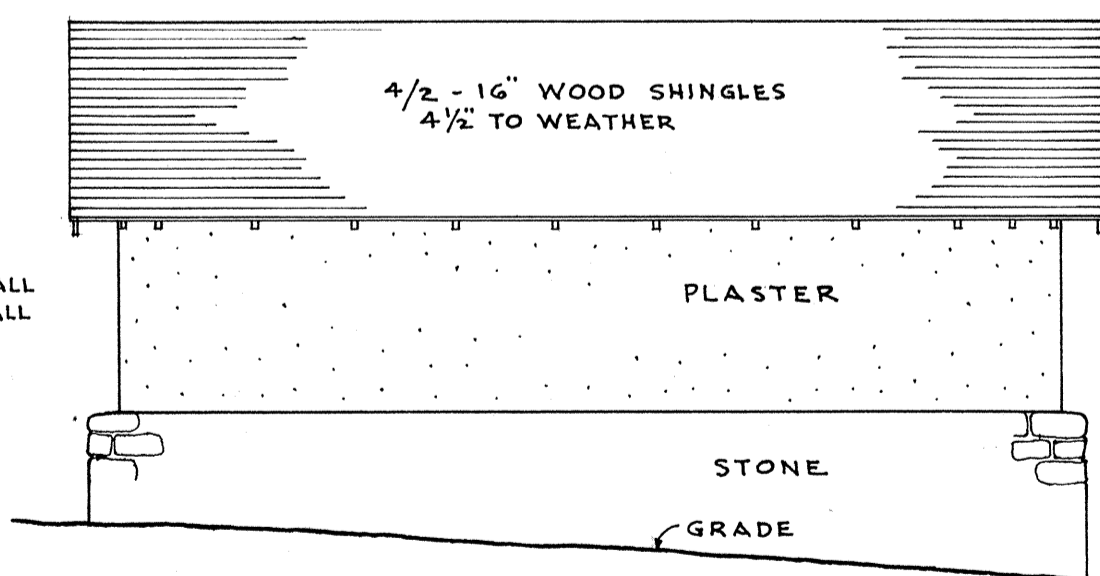

NORTHWEST ELEVATION

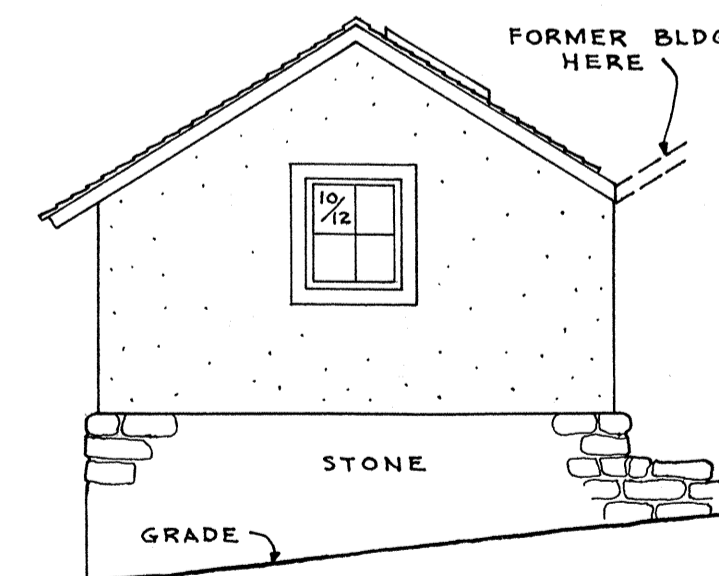

SOUTHWEST ELEVATION  
SCALE 1/4"=1'-0"

MATERIAL SCHEDULE

	LIME & AGGREGATE (CONCRETE)
	STONE
	PLASTER
	WOOD IN SECTION

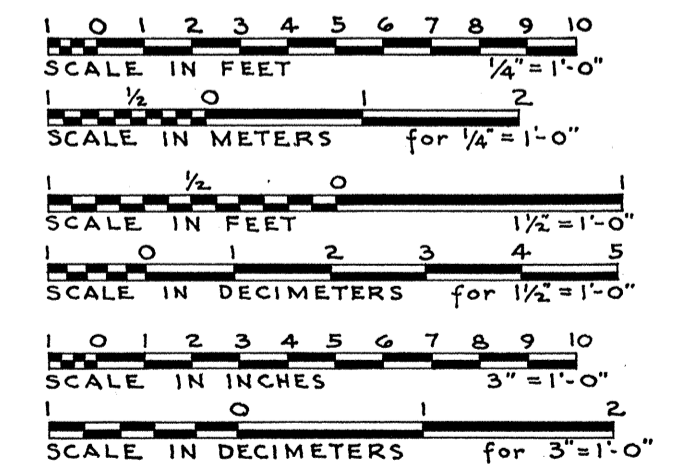

UNDER DIRECTION OF UNITED STATES DEPARTMENT OF THE INTERIOR  
NATIONAL PARK SERVICE, BRANCH OF PLANS AND DESIGN

NAME OF STRUCTURE  
**STABLE**  
FORT LARAMIE NATIONAL MONUMENT

SURVEY NO.  
**WYO-12**

HISTORIC AMERICAN  
BUILDINGS SURVEY  
SHEET 1 OF 1 SHEETS

LIBRARY OF CONGRESS  
INDEX NUMBER



