

Color the symbol for the National Park Service. The arrowhead shape is for history parks. The buffalo, trees, and mountain are for the nature parks. Which do you like better?

The National Park Service tries to take care of places so you can visit. We want the places kept nice for you, your children, and your children's children. What can you do to help? _____

This book belongs to _____

Junior Rangers need to complete at least one activity in this book for each year of age (for example: 6 year old children finish 6 activities, 12 year old children finish 12). The Junior Ranger may choose which activities they want to work on and can do extra pages if they wish.

This is NOT a test and is intended to be fun! Junior Rangers can work with others, ask questions of park staff, and need to use their imagination and creativity.

A trip into the Past

They Did It First

Some of these Portage Railroad innovations are still used today.

Sectional Canal Boat

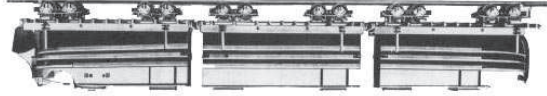

Tandem Truck

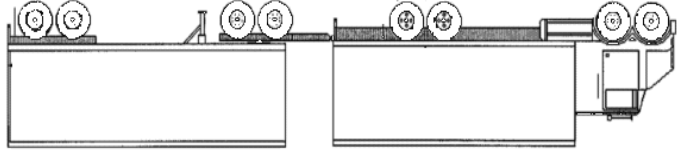

Shipping Container



Shipping Container

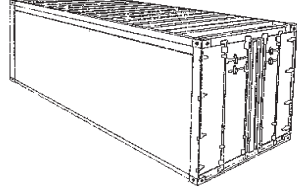

Safety Car

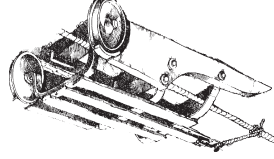

Safety wedges/chocks



Do you think you would like to time travel back to the days of the real Portage Railroad? What would your day be like in the year 1840? This book should give you a few ideas about how life would be different.

If you really did have the chance to time travel how long would your visit to the past last? One day? One week? An entire year?

What modern things might you miss?

Are there good things about 1840 that today's children are missing?

Who would you take with you on your time travels?

Activity 15: Lessons from the Past

A man named George Santayana wrote “those who do not remember the past are condemned to repeat it.” There are lessons to learn from history and you do not need a time machine to discover them.

What have you discovered at this park?

Why do you think this is a National Park?

What do you think Mr. Lemon might say if he saw things as they are today?

Activity 1: Famous Portage Travelers

There are famous people who used the Portage Railroad. Have you heard of them? The exhibits in the Lemon House will help.

Guess the middle name of these travelers.

William _____ Harrison

Ulysses _____ Grant

Charles _____ Dickens

Jenny _____ Lind

Fanny _____ Kemble

Harriet _____ Beecher Stowe



John



Henry



Simpson



Elizabeth



Maria



Anne

Activity 2: The Main Line Canal

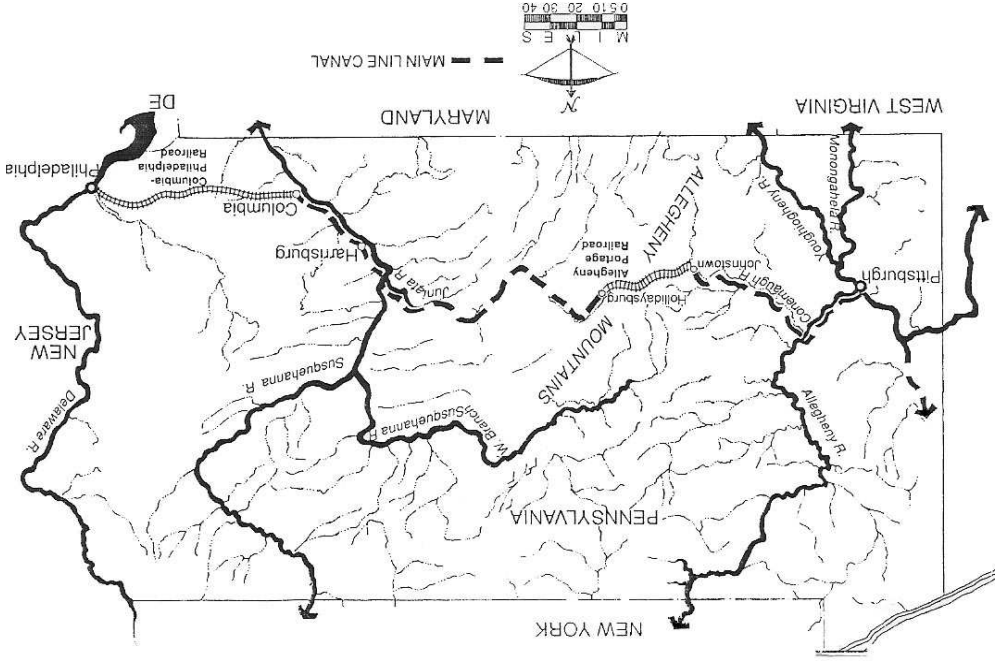

Can you name two of the rivers very important to the Main Line Canal System?
MENCOGAHU

Which two cities are connected by the Allegheny Portage Railroad?
NUATJIA

BGHDOLYRISULA
SHOJWTON

P	C	C	L	Z	G	W	B	N	S
D	E	I	O	L	S	L	O	O	T
T	Q	T	O	R	O	R	N	R	O
S	D	V	T	O	S	F	N	P	C
N	E	M	M	I	V	E	A	K	I
S	K	E	M	E	C	E	T	R	I
Y	R	E	C	N	U	O	L	F	N
S	H	X	C	O	L	L	A	R	G
C	T	E	K	C	O	P	B	T	S
S	H	A	W	L	P	F	L	R	P

Circle these words in the puzzle.
 Do you know what they are describing?

APRON BLOOMERS BONNET CHEMISE COLLAR
 CORSET FLOUNCE GLOVES PETTICOAT
 POCKET SHAWL STOCKINGS

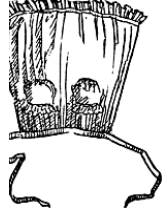

Activity 14: Women's Clothing

Ladies must wear many layers of clothing, often making it hard to breathe. The layers are required winter and summer. A lady never shows her legs, even a quick peek at her bare ankles could cause a scandal. Are you dressed properly?



There is something different about Pittsburgh on the hall map in the Lemon House. What is it?

SSIMIGN ASLT H

The money to pay canal builders and workers came from the state capitol. What city is the capitol of Pennsylvania?

BIRRASHRUG



Which state north of Pennsylvania is a competitor in canal building?

Hint: the state that built the Erie Canal.

EWN RYOK

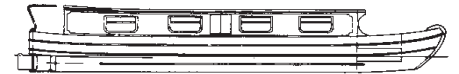

What is the name of the Maryland canal that goes to Georgetown, near Washington DC?

Hint: you can still take canal boat rides there!

PEESACKAHE DAN IHOO

Activity 3: Locomotives could not do it

The trains of 1830 and 1840 do not have the power to go up hills. That's why Pennsylvania uses the Portage Railroad to cross the mountains.

Can you find the two engines that are exactly the same?

Circle them.

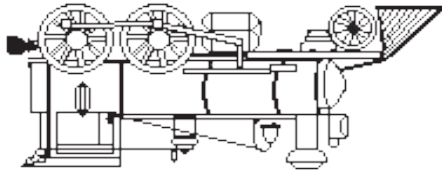
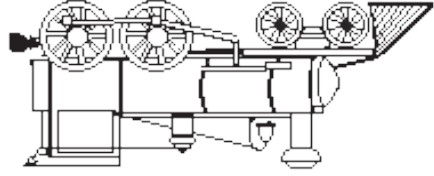
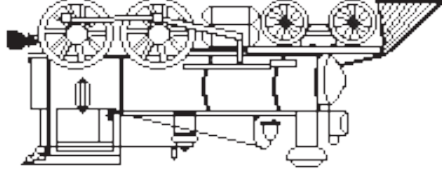
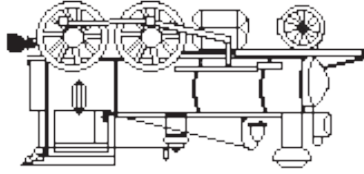
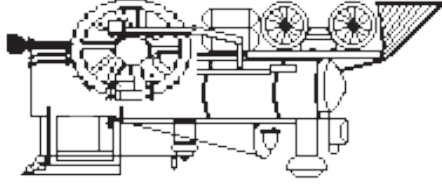
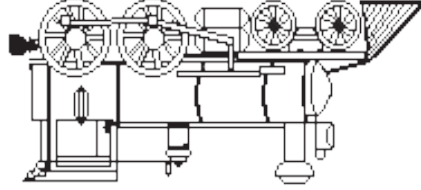
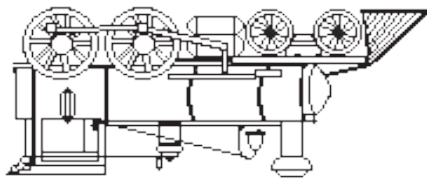
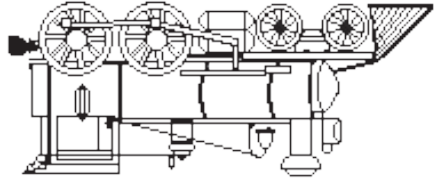

T	S	A	Y	S	C	S	F	S	
R	A	L	O	T	Q	R	Y	I	G
I	Q	O	P	E	A	R	B	N	
H	K	O	C	S	H	V	R	Q	I
S	B	W	U	K	X	A	D	H	K
N	B	O	R	V	C	T	T	X	C
B	R	M	N	E	E	O	L	R	O
T	M	D	S	Q	Z	S	R	Z	T
T	A	I	L	C	O	A	T	F	S
S	E	V	O	L	G	P	V	G	B

Circle these words in the puzzle.
Do you know what they are describing?

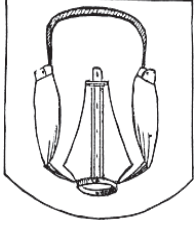

BOOTS BRACES CRAVAT FROCKCOAT
GLOVES SHIRT STAYS STOCKINGS
TAILCOAT TOPHAT TROUSERS VEST

Activity 13: Men's Clothing

Our ideas of fashion are always changing. There are many more 'rules' about clothing at this time. What must a man wear, or not wear, today?



Activity 4: Engine Houses

The Allegheny Portage Railroad uses stationary engines to move cables towing traincars up or down hills. There are 10 engine houses, each at the top of an incline (hill).

Look at the hemp rope inside Engine House #6. Which knot would work best to hold the railroad cars to the rope? How many of these knots can you tie?

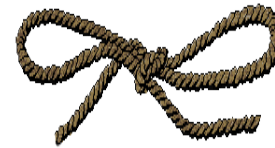

Bow Knot



Figure 8 Knot



cat's paw knot



Bowline knot



Overhand knot



granny knot



cow hitch knot



slip knot



sheep shank knot

Activity 12: Fun in the 1800s

There are plenty of stories, toys and games for children to enjoy while traveling. Look for some of them in the Lemon House or in the Visitor Center bookstore. Have you played a travel game today?

Draw a picture of you having fun in 1840:

The first bridge built to let the wagon road cross Incline number 6 was made in the usual way. The wagonmasters didn't like that because they had to make a hard turn to use the bridge. That bridge was taken apart and rebuilt, this time twisted or skewed, so the wagons cross the incline at an angle. Can you find the bridge's keystone?

Take the letters "SKEWARCH" and see if you can make at least 8 words of four or more letters.

weak

search

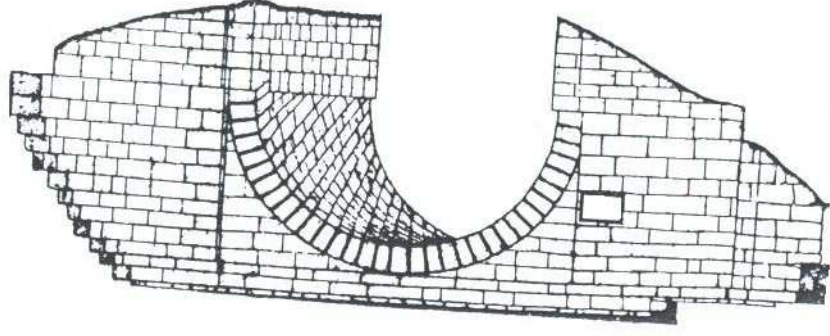

_____	_____
_____	_____
_____	_____
_____	_____
_____	_____
_____	_____

Activity 5: Skew Arch Bridge

Activity 11: Chores

Everyone has jobs to do in order to keep the house clean and neat. What jobs do you do at home? How would they be done in 1840?

Match the modern tool with what it looked like in 1840.

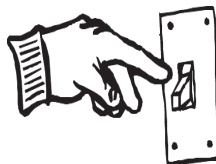
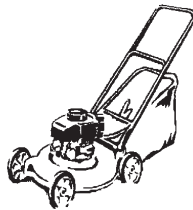
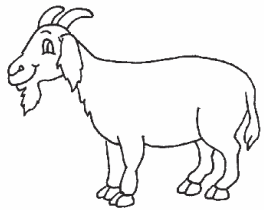
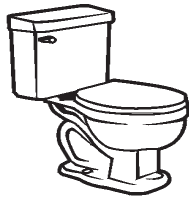

Activity 6: Staple Bend Tunnel

The Staple Bend Tunnel may be the first railroad tunnel in the United States. It helped to make the portage a few miles shorter. The tunnel is 901 feet long. Do you know where the tunnel can be found?

How would you feel after going through your first railroad tunnel? Draw a picture or write a message about your trip going through a tunnel.

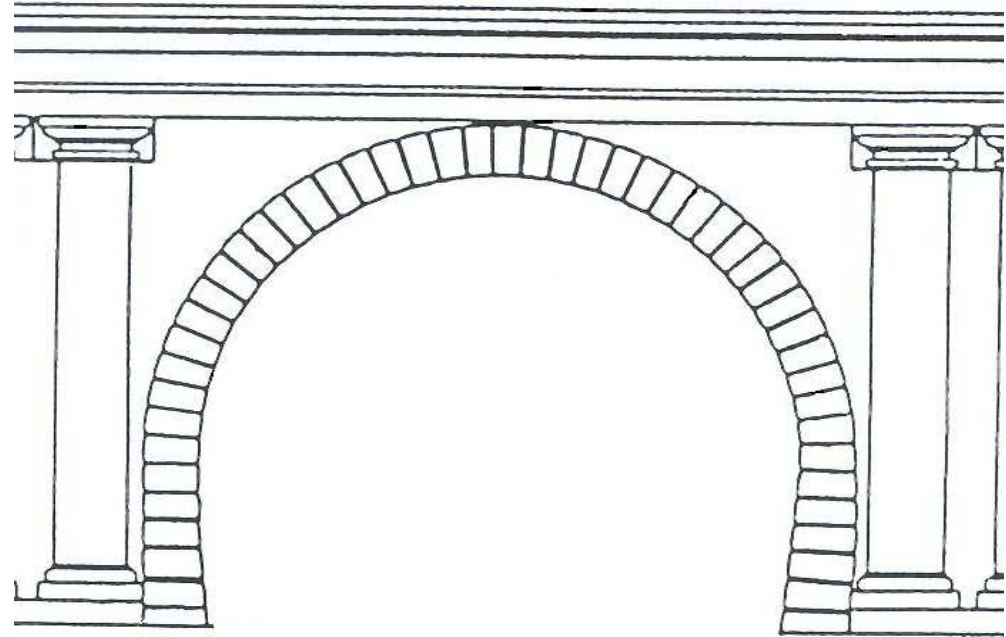

Activity 10: Canal and Railroad Workers

Workers are needed for building the canals and the Portage Railroad. The Commonwealth of Pennsylvania wants to keep costs down so their idea of a 'fair' wage may not be what most people think is fair. Irish immigrants, escaping from the lack of food in Ireland, are building most of America's canals and the Portage Railroad. Are they always treated fairly?

Solve the maze to get from Ireland to the United States.

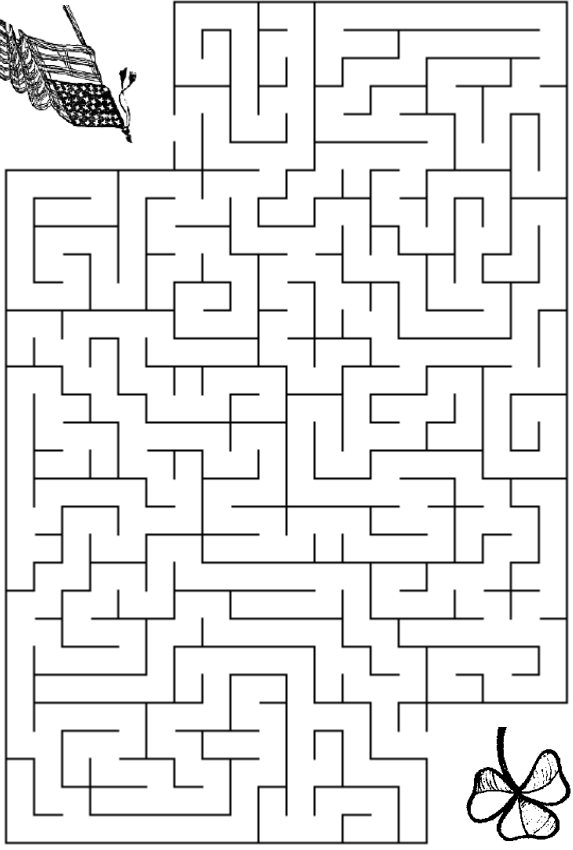

Activity 7: Wagons and Roads

By 1804 a traveler could take a stage coach from Philadelphia to Pittsburgh. Since 1835, two four-horse stages pass each way daily over the Pittsburgh Pike; on the National Road eight stages daily carry passengers and mail.

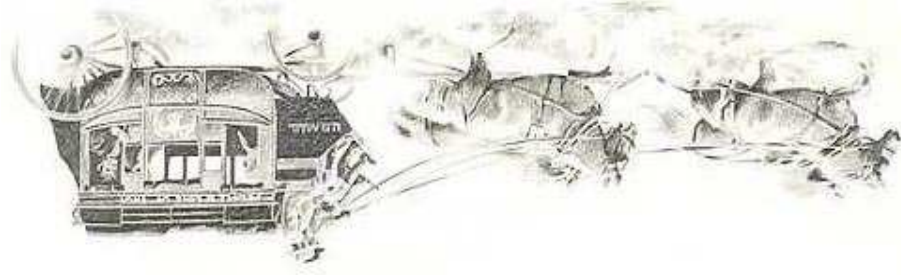

Do you know the parts of a stage coach? Can you fit the word from the list where it goes in the puzzle?

Across

- 4. stops the coach
- 6. holds the horses to the coach
- 9. where the man holding the reins sits
- 10. holds luggage, or extra passengers
- 11. center of the wheel, holds wheel onto coach
- 13. part of the center of the wheel

Down

- 1. where you pack in paying travelers
- 2. keeps the dust out of the coach
- 3. outer edge of the wheel
- 5. control the horses
- 7. next to the driver, the place to watch for bandits
- 8. carry US mail
- 12. back storage area

Activity 9: The Engine House

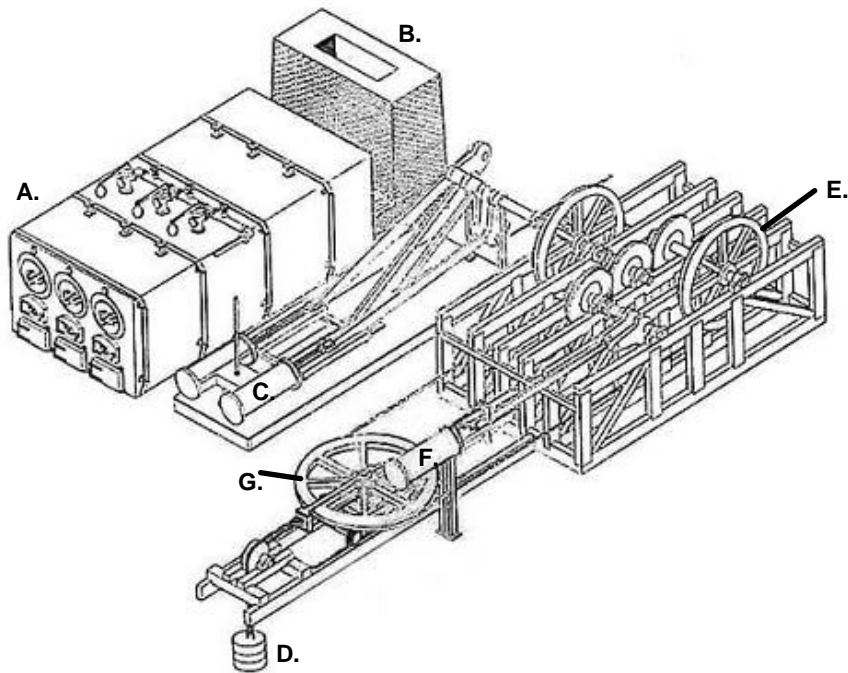

What is what in the Engine House? Match the letter from above with the correct part below.

- Vertical Sheave _____
- Boiler _____
- Cylinder _____
- Horizontal Sheave _____
- Weight _____
- Chimney _____
- Water Brake _____

1

2

3

4

5

6

7

8

9

10

11

12

13

Word List

- Axel
- Boot
- Brake
- Driving seat
- Leather curtains
- Mailbag
- Passenger seats
- Reins
- Shafts
- Shotgun Seat
- Spokes
- Tires
- Top railing

Activity 8: The Lemon House

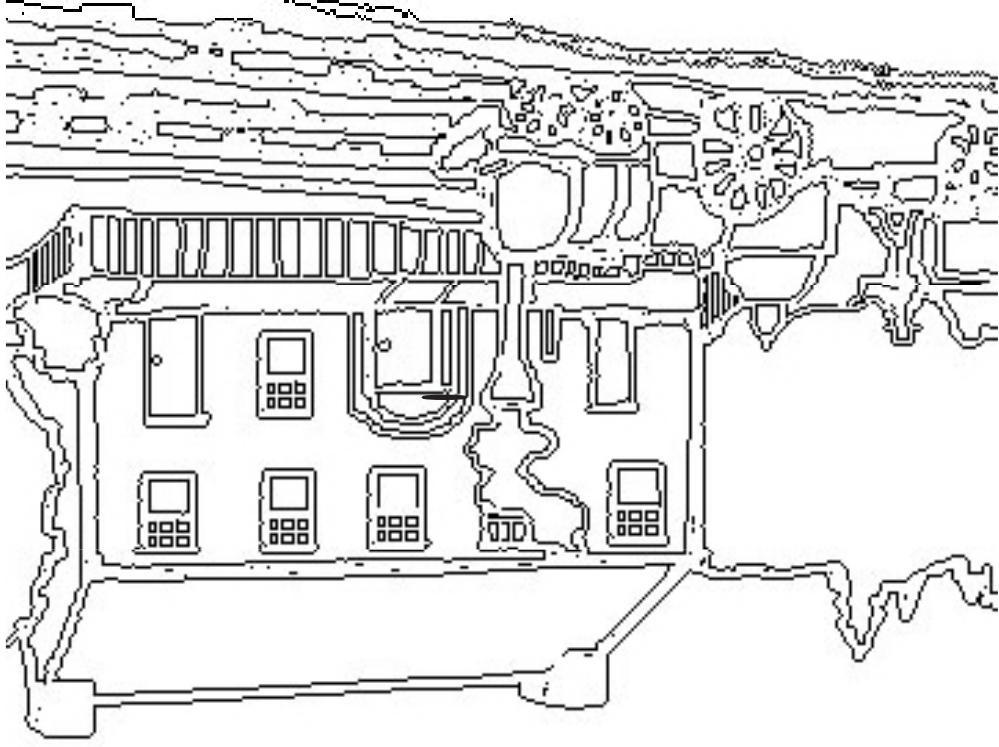

This alphabet code can help you answer the Lemon House questions.

A	B	C	D	E	F	G	H	I	J	K	L	M	N	O							
1	2	3	4	5	6	7	8	9	10	11	12	13	14	15							
P	Q	R	S	T	U	V	W	X	Y	Z	16	17	18	19	20	21	22	23	24	25	26

Why do people travelling on the Main Line Canal or Portage Railroad need a rest stop?

2 1 20 8 18 15 15 13 2 18 5 1 11

Why is it called the Lemon House?

13 18 12 5 13 15 14 15 23 14 19 9 20

In 1840 the area around the Lemon House has farm animals and plenty of noise from the railroad. What do you expect to smell outside of the house?

20 18 1 19 8 19 13 15 11 5 13 1 14 21 18 5

How do you heat the Lemon House?

23 15 15 4 3 15 1 12 9 14 19 20 15 22 5 19

15 18 6 9 18 5 16 12 1 3 5 19