

STIRLING'S QUARTERS AT VALLEY FORGE NATIONAL HISTORICAL PARK  
HISTORIC STRUCTURE REPORT



*Stirling*

PREPARED BY:  
JOHN MILNER ARCHITECTS, INC.  
104 LAKEVIEW DRIVE, CHADDS FORD, PA 19317

SUB-CONSULTANTS TO:  
BARGMANN HENDRIE + ARCHETYPE, INC.  
316 SUMMER STREET, BOSTON, MA 02210

JANUARY 2006

**TABLE OF CONTENTS**

	<u>Page</u>
EXECUTIVE SUMMARY .....	3
ADMINISTRATIVE DATA .....	5
PART 1. DEVELOPMENTAL HISTORY	
1.1. Historical Background and Context.....	7
1.2. Chronology of Development and Use .....	18
1.3. Physical Description .....	28
1.4. Structural Evaluation.....	159
1.5. Materials Analysis .....	174
PART 2. TREATMENT AND USE	
2.1. Treatment Philosophy .....	181
2.2. Character Defining Features.....	182
2.3. Use and Interpretation of the Resource .....	186
2.4. Code Review .....	196
2.5. Treatment Priorities.....	200
2.6. Room/Feature Treatment Recommendations.....	201
BIBLIOGRAPHY .....	210
APPENDICES	
A. Building Chronology Drawings	
B. National Register of Historic Places Nomination Form	
C. Chain of Title	
D. Structural Engineer Letter Report - Gredell & Associates	
E. Preliminary Drawings of 1926 Renovations - Boyle Irwin	
F. Historic American Buildings Survey (HABS) Drawings	
G. Selected Archive Photographs	

## EXECUTIVE SUMMARY



## EXECUTIVE SUMMARY

Valley Forge National Historical Park intends to undertake the preservation and renovation of the building known as the Quarters of Major General Lord Stirling, located on north side of Yellow Springs Road near the western edge of the Park. As a basis for the planning and design of the project, Valley Forge National Historical Park has commissioned the preparation of this Historic Structure Report by Bargmann Hendrie + Archetype, Inc., with sub-consultants John Milner Architects, Inc. (Task Order #T4560041008, Stirling's Quarters HSR, Valley Forge NHP).

The following primary tasks were carried out in preparing the HSR:

1. Archival Research to retrieve information related to the significance and development history of the building and site.
2. Architectural investigations to retrieve and document physical evidence of the construction chronology of the building, to assess existing conditions and to formulate the scope of required preservation and conservation work.
3. Structural investigations to assess and document the existing condition of the building's structural components, and to assess the capacity of those systems to accommodate the proposed use.
4. Statement of recommended treatment philosophy consistent with the appropriate period of significance and proposed use for the buildings.
5. Statement of recommended treatment, use(s) and interpretation of the property.
6. Statement of treatment priorities.

These tasks are addressed in detail in the HSR. As a separate component of the same Task Order, a set of HABS measured drawings was prepared to document the existing conditions of the house and attached outbuildings.

The original section of Stirling's Quarters was built in 1769 by Reverend William Currie, a missionary minister of the Church of England who served the parishes of St. David's in Radnor, St. Peter's in the Great Valley and St. James in Perkiomen. While Reverend Currie was a well-known and rather controversial figure, by virtue of his continued allegiance to the Anglican Church during the Revolution, his residence gained its primary significance as the Quarters of Major General William Alexander, Lord Stirling during the Continental Army's 1777-1778 winter encampment at Valley Forge. The building was expanded incrementally c. 1790, c. 1810, c. 1830 and in 1926.

Architectural investigations revealed extensive physical evidence in support of the construction chronology. This evidence is presented in the form of detailed descriptions, annotated photographs and annotated existing-conditions drawings, organized façade-by-façade, room-by-room and feature-by-feature. An assessment was made of the building's structural components, and recommendations were made for the remedial work required to ensure continued structural stability consistent with the proposed use.



With regard to options for treatment of the building, the following three potential time periods were identified and considered:

- 1769-1778.** advantages: encompasses the original construction by William Currie and accurately represents the building during the encampment period.
- disadvantages: requires removal of significant portions of the existing building, reducing the amount of available space for reuse; requires a degree of conjecture to achieve an accurate restoration of the building.
- 1790-1830.** advantages: encompasses the alterations and additions made to the original building through the Walker period.
- disadvantages: does not accurately represent the building's appearance during the encampment period; requires removal of post-1830 additions, reducing the amount of available space for reuse; requires a degree of conjecture to achieve an accurate restoration.
- 1926.** advantages: maximizes the available space for reuse; does not remove fabric dating from c. 1790-1926; preserves the option for future restoration; affords opportunity for broad interpretation of the site and its evolution.
- disadvantages: does not accurately represent the building's appearance during the encampment period.

In consideration of these options and the requirements of the Park for reuse, preservation and renovation of the building to its appearance in 1926 is the most appropriate action. The recommendations presented for treatment and treatment priorities are based on this action.

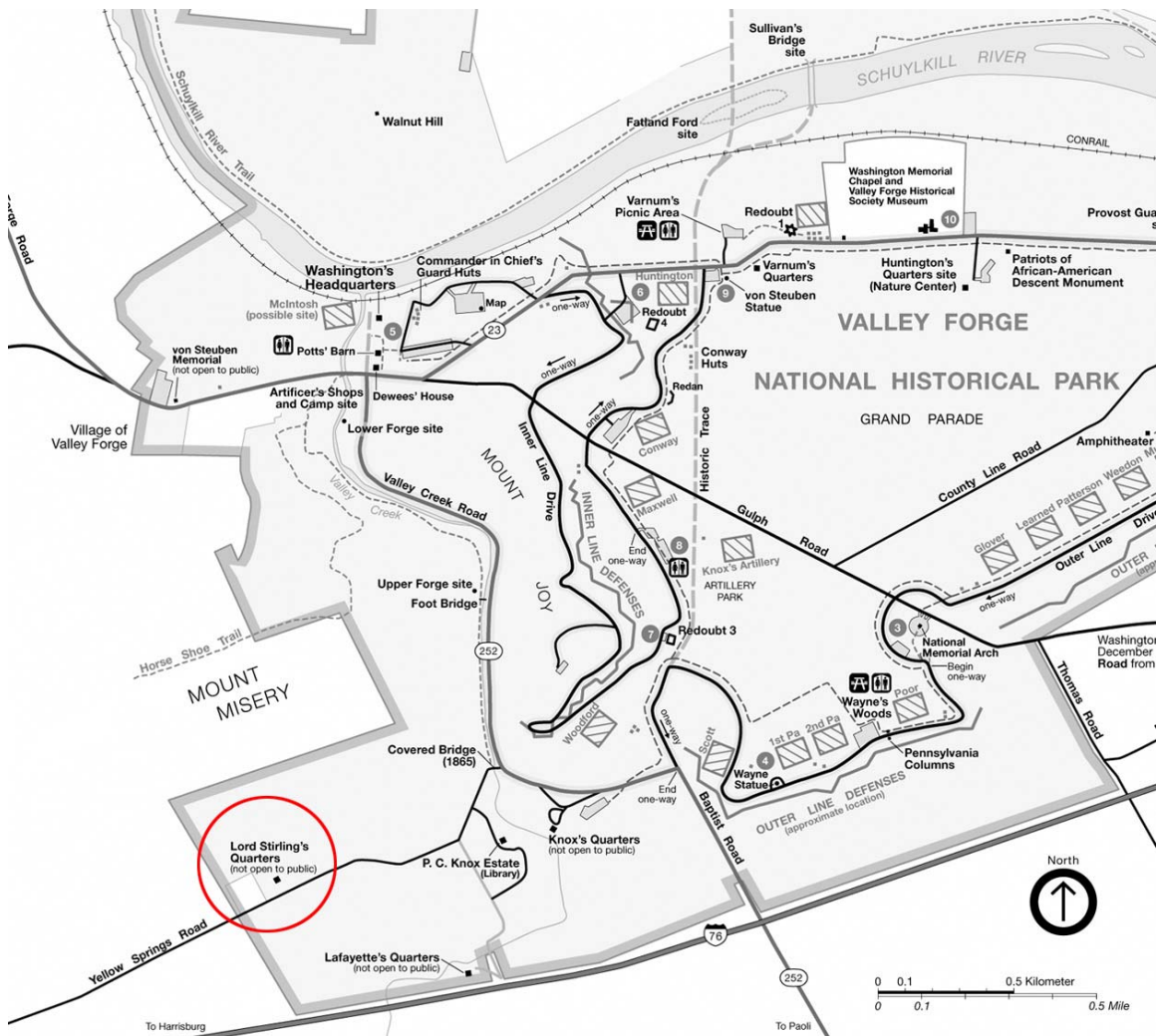
**ADMINISTRATIVE DATA**



ADMINISTRATIVE DATA

RESOURCE: Major General Lord Stirling's Quarters  
(also known as "Echo Valley Farms" during Liggett occupancy, 1926-1978)

LOCATION: 555 Yellow Springs Road  
Tredyffrin Township, Chester County, Pennsylvania  
(currently located within Valley Forge National Historical Park)



Detail section of the Official Map of Valley Forge National Historical Park as published by the National Park Service, U. S. Department of the Interior. Location of Stirling's Quarters site is indicated in red.

**NATIONAL REGISTER OF HISTORIC PLACES STATUS:**

Building Number:	74000283
Date Listed:	February 1974
Significance:	Military; Architecture; Agriculture
Period of Significance:	1750-1799 (Winter of 1777-78)

**PRIOR STUDIES:**

- Dodd, John B. "Classified Structure Field Inventory Report: Quarters of Major General William Alexander, Lord Stirling." September 1979.
- Rhoads, Ann F., Douglas Ryan, and Ella W. Aderman. "Land Use Study of Valley Forge National Historical Park." March 1989.
- University of Pennsylvania, Historic Preservation Program. "Stirling's Headquarters: An Historic Structures Report Developed for Valley Forge National Park." May 1994.
- John Milner Associates, Inc. with Skidmore, Owings, and Merrill, LLP. "Archeological Investigations, Stirling's Quarters (VAFO-348), Valley Forge National Historical Park: Preliminary Field Results." June 28, 2004.

**RECOMMENDATIONS FOR FUTURE STUDY:**

- In-depth sampling and mapping of exterior stuccos and interior plasters to establish comprehensive typology; data to be used to further inform chronology of construction, alterations and repair.
- Archeological and architectural investigations of the small barn located to the northeast of the main house to determine chronology of construction and subsequent alterations; archival research to identify original purpose and specific uses of the outbuilding within the context of 19<sup>th</sup>-century agricultural practices.
- Investigation of masonry at north side of second-floor chimney mass and at north cheek wall in the main block for evidence that the north chamber could have been heated originally by a five-plate, or jamb, stove; the Inventory made of William Currie's estate at the time of his death in 1803 includes "1 Open Stove" valued at 6£ (see Chester County Estate File No. 5056).
- Comprehensive investigation of east and west masonry walls for evidence of a stone drip course that might relate to roofs covering the bake ovens.
- Archeological investigations of the bakehouse to further determine the nature of the cooking fireplace and bake oven alterations and to more precisely determine the uses of the space over time.

**PART 1**  
**DEVELOPMENTAL HISTORY**



# 1.1 HISTORICAL BACKGROUND AND CONTEXT



## **PART 1. DEVELOPMENTAL HISTORY**

### **1.1 HISTORICAL BACKGROUND AND CONTEXT**

Stirling's Quarters, as the property is currently known, is named for one of George Washington's most distinguished Continental Army officers, Major General William Alexander, Lord Stirling (1726-1883). The significance of the property is largely due to Stirling's supposed occupation of the house and farmstead during that legendary winter of 1777-1778. James Monroe (1758-1831), who later became the fifth President of the United States, joined Stirling's staff as aide-de-camp in November 1777 and may also have occupied the house during the Army's encampment at Valley Forge. The property is also significant as the former residence of the Reverend William Currie (1710-1803), missionary minister of the Church of England to the parishes of St. David's in Radnor, St. Peter's in the Great Valley, and St. James' in Perkiomen from 1737-1776.

#### **Reverend William Currie**

According to Chester County deed records, the owner of the property at the time of the Valley Forge encampment was the Reverend William Currie.<sup>1</sup> Currie was born in Scotland circa 1710 and attended college in the city of Glasgow. Educated as a Presbyterian minister in the Church of Scotland, Currie first arrived in the New World circa 1730 as a tutor for the son of a wealthy Virginia planter. After several years in Virginia, Currie journeyed north and found assignment among the Presbyterian Congregation at New Castle (still part of Pennsylvania at that time), where he became acquainted with the Reverend George Ross, a missionary and one of the founders of the Anglican Church in America. During his tenure in New Castle, Currie apparently grew fond of the Reverend Ross's eldest daughter, the widow Margaret Ross Hackett, and eventually asked for her hand in marriage. As a condition of receiving her hand, as the story is told, Currie was first obliged to withdraw from the Church of Scotland and join the Anglican Church. With high recommendations from Reverend Ross, Currie traveled back to London to seek ordination in the Church of England. He was ordained a priest in 1736 by the Bishop of London. Upon his return to Pennsylvania, Currie married Margaret and was appointed by the Venerable Society for the Propagation of the Gospel in Foreign Parts as missionary minister to the churches of St. David's in Radnor, St. Peter's in the Great Valley, and St. James' in Perkiomen.

Currie first arrived in the Great Valley circa 1737. Throughout his term as Pastor of the three churches, Currie owned several properties in the vicinity. An advertisement in the *Pennsylvania Gazette* on December 17, 1761 announced the sale of two of his properties at the time:

"To be sold on public Vendue, . . . a valuable Plantation, situate in the Great Valley, Chester County, 18 Miles from Philadelphia, containing 200 acres of rich Land, together with 80 Acres at a small Distance . . . The said Plantation hath on it a good Stone dwelling house, Barn, Stables, Cow house, Chaise house, and Necessary house, all in good repair."<sup>2</sup>

---

<sup>1</sup> Chester County Deed Book P, Vol. 15, p. 129; Chester County Deed Book P, Vol. 15, p. 132.

<sup>2</sup> *The Pennsylvania Gazette*, 17 December 1761. Item #27841 in *The Pennsylvania Gazette, 1720-1800*, Accessible Archives Inc. [database online] [cited 20 December 2004].



It was not until 1767 that Currie acquired the property that would eventually become the site of Stirling's Quarters. According to date stones located in the southwest corner of the house's original kitchen wing and a stucco panel in the west gable end of the central block, construction of these original sections of the house was undertaken circa 1769.<sup>3</sup> Currie's tenure on the property, therefore, had been well established for more than seven years before the Continental Army arrived for the winter of 1777-1778.

In accordance with his ordination vows as a minister of the Church of England, Currie was obligated to include prayers for the King and Royal Family as part of his religious services. As events propelled the American Colonies toward war with England, it became difficult for Anglican clergy throughout the Colonies to maintain their allegiance to the Church of England. Conflicts often arose over their sworn support of the King and their obligations to serve their increasingly divided congregations. With his parishioners likely comprised of both Loyalists and Whigs, Currie's position as a minister of the Church of England grew increasingly tenuous as war approached. Tradition and oral history describe the general refusal of his congregations to allow the continued use of prayers for the British monarch. As he continued to pray for King George and his family according to his ordination vows, a large majority of the congregants from all three of the churches supposedly objected to his unabashed allegiance. One particular incident was recorded by a parishioner of St. Peter's:

"... during the course of the Litany [Reverend Currie] read, 'That it may please Thee to keep and strengthen in the true worshipping of Thee, in righteous and holiness of life, Thy Servant George, our most gracious King and Governour,' a dead silence ensued and instead of the usual response, 'We beseech Thee to hear us, good Lord,' a single and distinct voice from the gallery answered, 'Good Lord deliver us.'"<sup>4</sup>

According to tradition, Currie was ultimately driven from his position as Pastor by the hostility of his parishioners which may even have included threats of violence. The historical record does not appear to confirm such animosity. In May of 1776, Currie presented letters of resignation to the Wardens and Vestrymen of the Church of St. David's citing his elderliness and physical condition as the reason for his premature departure:

"Age and Infirmity having rendered me unable to officiate any longer, I take this method to let you know that I shall decline attending your Church any more, but though providence has so ordered that I can Serve you no more in public yet God forbid that I should cease to pray for you in private . . . Thus my dear little flock I bid you heartily farewell, & am with great love & affection your faithful pastor till death."<sup>5</sup>

Currie failed to mention any enmity or conflict as reason for his resignation, and strongly affirmed his continued "love & affection" for his parishioners. A similar letter

---

<sup>3</sup> Archival photographs of the southwest corner of the building taken by Ken Block in April 1984 (VAFO #6372 & #6373) reveal five sets of initials "M.C.," "R.C.," "W.C.," "R.C.," and "I.C." Three of these sets of initials are currently exposed. At least two of the initial sets include associated dates of 1769. A stucco panel with the inscription "1769" is also located at the west gable end of the central block in a recess just below the peak.

<sup>4</sup> Quotation attributed to Dr. Julius Sachse as quoted in *Parish News*, March 1975, St. Peter's Church, Great Valley, Pennsylvania.

<sup>5</sup> William Currie to the Wardens and Vestrymen of St. David's Church, 18 May 1776, photocopy from archives of St. David's (Radnor) Church, Radnor, PA.

was also presented to the wardens of St. James'. Throughout the war years, Currie apparently held no public services, but continued to perform his ministerial duties of baptism, marriage and burial of the dead. Currie was invited back to St. David's Church after the War where he continued his service from 1783-1785. Throughout the remainder of his life he appears to have maintained his ties with St. David's. In his Last Will and Testament signed in 1794, Currie bequeathed to the ". . . Vestry of Radnor Church Ten pounds like money . . . to help to keep ye Wall about their Graveyard in constant repair" and "ye few books left in my Library . . . for ye use of their Minister."<sup>6</sup>

William Currie had seven children by his first wife, Margaret. His six sons were named John, James, William, Richard, Alexander and Ross; his only daughter was named Elizabeth.<sup>7</sup> His wife Margaret died in 1771 and was buried in the churchyard at St. David's in Radnor. Currie remarried Lucy Ann Jones, the widow of David Jones, in November of the same year. Lucy was fifteen years his junior. She died in February 1778 and was also buried at St. David's.

Currie appears to have remained loyal to the Church of England and to the British Crown throughout his life and apparently never became a United States citizen.<sup>8</sup> Currie's family, however, by blood and marriage were much more sympathetic to the Revolutionary cause. George Ross, son of the Reverend George Ross and brother of his wife Margaret, was a signer of the Declaration of Independence. Three of Currie's sons served in the Continental Army; his son Richard died of camp fever in 1776.

In 1791, Currie eventually sold his house and associated property to Thomas Walker, who had married his granddaughter, Margaret, in 1789. William Currie remained on the property, however, and lived out his days in the house in Tredyffrin Township until his death in 1803.<sup>9</sup> He is buried with his two wives and son Richard in the churchyard at St. David's.

### **Major General William Alexander, Lord Stirling**

At the time of the Continental Army's encampment at Valley Forge, the Currie house was reputedly occupied by Major General William Alexander, Lord Stirling and his entourage. William Alexander was a renowned military officer and an intriguing historical figure. Although he was born in New York City and fought with distinction for the cause of American independence, he vigorously maintained throughout his life a rightful claim to the Scottish Earldom of Stirling, to which his father had been heir presumptive. After formally presenting his case to the Scottish authorities, an Edinburgh jury determined in 1759 that he was, in fact, the nearest living heir to the last Earl of Stirling, yet his right to that title and the associated estates, which included vast acreage in Nova Scotia, was never officially recognized by the British House of Lords. Despite his inability to obtain formal acknowledgment of his claim from the British

---

<sup>6</sup> William Currie, Last Will and Testament, Chester County Estate File No. 5056, Chester County Archives and Records, West Chester, PA.

<sup>7</sup> "Descendants of William Currie (1710-1803) of Delaware County, Pennsylvania" from the collections of the Historical Society of Pennsylvania, Philadelphia, PA.

<sup>8</sup> Virginia Bloodgood, "Biographical Notes: Reverend Mr. William Currie, Missionary to St. David's Church, Radnor, 1737-1776, 1783-85," from correspondence of Frances H. Liggett, Valley Forge National Historical Park Archives, Valley Forge, PA.

<sup>9</sup> Henry Pleasants, *The History of Old St. David's Church, Radnor, Delaware County, Pennsylvania* (Philadelphia: The John C. Winston Company, 1915), 159.

government, William Alexander continued to refer to himself by his noble title and was respectfully addressed as Lord Stirling by General Washington and many of his American peers.

William Alexander began his military career in the 1750s during the French and Indian War as aide-de-camp to the British General Sir William Shirley. In 1756, he accompanied Shirley to England to aid in Shirley's defense against charges of neglect of duty before the House of Commons. Alexander remained in England for the next several years while attempting to secure recognition of his own claim to the lapsed Earldom of Stirling. Although he failed to receive official recognition from the British government of his hereditary nobility, he was quite familiar with both privileged society and the political affairs of his time. Upon his return to America in 1761, he began the development of a sizeable estate which would eventually become his permanent residence, a tract of about seven hundred acres in Basking Ridge, New Jersey that he had inherited from his father. He married Sarah Livingston, the eldest daughter of Philip Livingston, a signer of the Declaration of Independence and the head of a wealthy New York family. Lady Stirling, as she was known, was also the sister of William Livingston, a member of the Continental Congress and the first Governor of the State of New Jersey. Stirling himself served as a member of the Provincial Council of New Jersey, as well as Surveyor-General of the colony. He became an outspoken opponent of the Stamp Act of 1764 and readily espoused the defense of American civil liberties in response to the Coercive Acts of 1774.



**Figure 1:** Portrait of William Alexander, Lord Stirling from *The Life of William Alexander, Earl of Stirling* published by Wiley and Putnam in 1847.

In November 1775, at the start of the war with England, Stirling was appointed Colonel of the first regiment of continental troops raised in New Jersey. In January of the following year, he distinguished himself by capturing an armed British transport, the *Blue Mountain Valley*, in New York Bay near Sandy Hook for which he received the official thanks of Congress. In March 1776, as he assumed command of forces in New York and supervised the fortification of the city and surrounding harbor, Congress promoted him to the rank of Brigadier-General. During the Battle of Long Island in August 1776, Stirling was captured by the British, but not before aiding the successful retreat of the Continental Army into New Jersey. After being freed in a prisoner exchange for the Governor of Florida, he rejoined the American forces. He participated in the Battles of Trenton and Princeton and eventually led the reserve troops under General Washington at the Battles of Brandywine and Germantown before the Army

withdrew to its winter encampment at Valley Forge. As the Continental Army was moving camp in December 1777, Washington stationed Stirling's division at Radnor Meeting House to patrol the roads and guard against enemy assault during the Army's relocation. Stirling eventually met the American forces at Valley Forge in January 1778. While at Valley Forge, he played a critical role in undermining the conspiracy against General George Washington known as the Conway Cabal. After Valley Forge, Stirling courageously led his forces at the Battle of Monmouth and also presided over the court-martial of General Charles Lee. Lord Stirling died January 15, 1783 while commanding the Northern Department of the Continental Army in Albany, New York.

### **The Valley Forge Encampment**

After a series of military defeats at the hands of the British in the fall of 1777, including the Battle of Brandywine and the Paoli Massacre, the future of the Continental Army under the leadership of General Washington was growing increasingly tenuous. By the end of September 1777, the British had defeated Washington's forces at Brandywine and had successfully occupied the American capital city of Philadelphia. In early October, the American forces mustered to launch an attack against the British position north of the city, but were again defeated at the Battle of Germantown. In spite of these setbacks, many of the American officers were reassured by the courage and spirited determination of the soldiery and the limited successes they did achieve. Following the defeat at Germantown, the ever optimistic General Stirling boldly declared that the British would now realize

“. . . that we can drive them before us for Several miles together, and that we know how to Retreat in good & defy them to follow us. We are now stronger than we were the day before yesterday, large reinforcements are nigh at hand, and the Enemy will find that after every Battle our Army will increase, and theirs diminish, this is fighting at such a disadvantage that they must soon be Convinced that they never can Support the war in America.”<sup>10</sup>

Despite Stirling's optimism, General Washington was ultimately compelled to move his forces to a defensive position in the aftermath of Germantown. Washington chose Whitmarsh where the Continental Army would remain camped for nearly six weeks while keeping a close watch on the British in Philadelphia. The hills at Whitmarsh were well suited to defend the supply routes to the west and to observe the British at the same time. In early December, the British launched a probe to test the American position leading to three days of non-decisive skirmishing in the hills. With winter approaching, supplies dwindling, and the prospect for further combat diminishing, debate began in earnest over the Army's next course of action.

After much deliberation among the military leadership, the civil authorities of the state of Pennsylvania, and representatives of the Continental Congress, it was decided that a winter campaign against an entrenched enemy in Philadelphia would be difficult and costly. An agreement was finally reached to establish a field camp in a location that would best allow continued surveillance of the British Army while limiting the Continental Army's exposure to surprise attack. As several delegates from the

---

<sup>10</sup> William Alexander, Lord Stirling, Letter dated October 5, 1777, Stirling Papers, New York Public Library, as quoted in Paul David Nelson, *William Alexander, Lord Stirling* (Tuscaloosa, AL: University of Alabama Press, 1987), 117.



Committee at Headquarters reported to Washington, "such a Post should be taken . . . as will be most likely to aggrieve the Enemy, afford supplies of provision, wood, water and forage, be secure from surprise and best calculated for covering the Country from the Ravages of the Enemy . . . as well as afford Comfortable Quarters for the Officers and Soldiers."<sup>11</sup> It was Stirling who suggested that Washington strongly consider making camp west of the Schuylkill River in the vicinity of the Great Valley:

"As to the plan of putting the Army into Huts in the Township of Tryduffrin [sic] in the great Valley, I must acknowledge it is a Situation well calculated for Covering Chester & Lancaster Counties, and for Checking any attempt the Enemy may design against Maryland & the Lower Counties on the one side and a Great part of the Country between the Schuylkill and Delaware on the other, the Communication in Jersey and the Northern States will be preserved, the Encampment will be easily guarded as there is but one way to approach from Philadelphia . . . Upon the Whole I should be for hutting the Army somewhere in or Near Tryduffrin [sic] especially if it is so fine and Rich a Country as has been represented."<sup>12</sup>



**Figure 2:** Detail from *A CHOROGRAPHICAL MAP, of the COUNTRY, round PHILADELPHIA* (c.1780) showing the "Grand American Winter Camp, Jan. 1778" at Valley Forge.

---

<sup>11</sup> Robert Morris, Elbridge Gerry and Joseph Jones to George Washington, December 10, 1777 in Paul H. Smith, et al., eds., *Letters of Delegates to Congress, 1774-1789*, vol. 8., September 18, 1777 – January 31, 1778 (Washington, DC: Library of Congress, 1976-2000), 401.

<sup>12</sup> William Alexander, Lord Stirling to General Washington, December 1, 1777, *George Washington Papers, 1741-1799: Series 4, General Correspondence, 1697-1799*, Library of Congress, Washington, DC.

In December 1777, Washington led 12,000 American troops from Whitemarsh through Gulph Mills and into Valley Forge to set up camp for the winter. Valley Forge had been named for an iron forge located along Valley Creek just south of the Schuylkill River. The topography of the Valley proved to be well-suited for the Army's logistical needs: the camp was close enough to Philadelphia to keep the British from raiding and foraging throughout the interior farmlands of Pennsylvania, and still far enough away to thwart the threat of surprise attacks. The high ground of Mount Joy and Mount Misery provided excellent vantage and the Schuylkill River provided a natural boundary to the north.

Although the location of the encampment appeared to be tactically ideal, the winter was harsh and physical conditions were severe. Supplies and rations were sporadic and meager. Approximately 2,000 of the roughly 12,000 troops encamped at Valley Forge died from sickness and disease.

More than 1,000 log huts were constructed as shelters for the troops. Many of the dwellings and farmhouses in the vicinity of the encampment were appropriated as quarters for the Continental Army officers. Exactly who was quartered where, however, with the exception of General Washington's Headquarters, is not clear.

Major General William Alexander arrived at Valley Forge in January 1778 and supposedly took up temporary residence in the house which has come to be known as Stirling's Quarters. It should be noted, however, that there is little primary source material to substantiate the claim that General Stirling was actually billeted in the Currie house while at Valley Forge. Although contemporaneous written accounts corroborating the specific location of Stirling's quarters may exist, none have been located to date. General Stirling did not refer to his Valley Forge accommodations in any but the most cursory terms in his personal correspondence.<sup>13</sup> Likewise, direct references by the Reverend William Currie concerning the lodging of General Stirling and his aides have not been found. The only known documented reference by Currie to the quartering of military personnel in his house can be found in the Minutes from the Venerable Society for the Propagation of the Gospel. In 1783, the minutes record a summary of one of Currie's letters written to the Society describing his condition during the Revolutionary War period:

"Having found it expedient to decline officiating in public ever since 1776, Mr. Currie has no account to give the Society, but that he continues in the performance of every other part of his function. He is hoping bills will be paid; if not his position is deplorable, as war has reduced him to very low circumstances. He has lost not only most of his substance, but likewise his wife, with whom he lived in his old age. They all died of camp fever and left him in the midst of the camp with one of the American Generals and his suite quartered in his house. He is left with three orphaned grandchildren, oldest seven, when parents died. He blesses God and he will die as he has lived, a true son of the Church of England even though he should have the misfortune to survive it."<sup>14</sup>

---

<sup>13</sup> Wayne Bodle and Jacqueline Thibaut, *Valley Forge Historical Research Report, Volume 3, In the True Rustic Order: Material Aspects of the Valley Forge Encampment, 1777-1778* (Valley Forge, PA: National Park Service, 1980), 83.

<sup>14</sup> Minutes from the Venerable Society for the Propagation of the Gospel in Foreign Parts, as quoted in Pleasants, *The History of Old St. David's Church*, 154.

As this reference suggests, “one of the American Generals and his suite” were indeed quartered in the Currie house during the Valley Forge encampment. The identity of Currie’s distinguished guests and the time and duration of their lodging, however, are not provided.

Various authors have written of the cordial relationship that apparently existed between General Stirling and his supposed host, but no documentation of these reported exchanges is provided. Historian Harry Emerson Wildes writes that “Parson Currie . . . was delighted when the accidents of war brought him as a guest a fellow Scot with many of his own tastes” and that “mentally Stirling and Currie were kin.”<sup>15</sup> Similarly, Edward Pinkowski writes that “when Lord Stirling came to his house, Rev. Currie opened his heart as much as one Scotchman could for another” and when Stirling’s wife and daughter supposedly arrived in camp, “they found Lord Stirling and Rev. Currie enjoying themselves as if they were brothers.”<sup>16</sup> Both authors also relate an anecdote about the two men stargazing together through a telescope set up behind the house.<sup>17</sup> Neither author cites particular correspondence or other documentary evidence, however, that may support these assertions.

According to an extensive research report prepared by Wayne Bodle and Jacqueline Thibaut for the National Park Service and Valley Forge National Historical Park in 1980, attribution of the house as Stirling’s Quarters “depends exclusively at this juncture upon cartographic evidence and tradition.”<sup>18</sup> The cartographic evidence itself is vague and inconclusive. A period map of the encampment, known as the Davis-Armstrong-Sparks Map, provides limited evidence of General Stirling’s occupation of the property.<sup>19</sup> The Sparks Map was reportedly delineated in 1833 by John Armstrong based on the recollection of a resident of Valley Forge at the time of the encampment named William Davis.<sup>20</sup> It is the only known map rendered within living memory of the encampment and shows “Lord Stirlings Qrs” in the vicinity of the Currie property (see Figure 3). Other maps of the period suggest, however, that Stirling may have been quartered at a different location. The Galloway Spy Map, delineated in March 1778 locates “Lord Sterlings Quarters” on the opposite side of Valley Creek to the west of a major north-south route (see Figure 4).<sup>21</sup> The so-called Pennypacker Map also designates a structure to the east of Valley Creek as “Lord Stirlings” (see Figure 5).<sup>22</sup> The particular circumstances surrounding these maps – i.e., the complexities associated with

---

<sup>15</sup> Harry Emerson Wildes, *Valley Forge* (New York: MacMillan, 1938), 161.

<sup>16</sup> Edward Pinkowski, *Washington’s Officers Slept Here* (Philadelphia: Sunshine Press, 1953), 99 -101.

<sup>17</sup> See Wildes, 160, and Pinkowski, 101.

<sup>18</sup> Bodle and Thibaut, 83.

<sup>19</sup> A copy of the Davis-Armstrong-Sparks Map is located in the Map Collection of the Valley Forge National Historical Park Archives. The original document is located at Cornell University Library, Ithaca, NY.

<sup>20</sup> Bodle and Thibaut, 17.

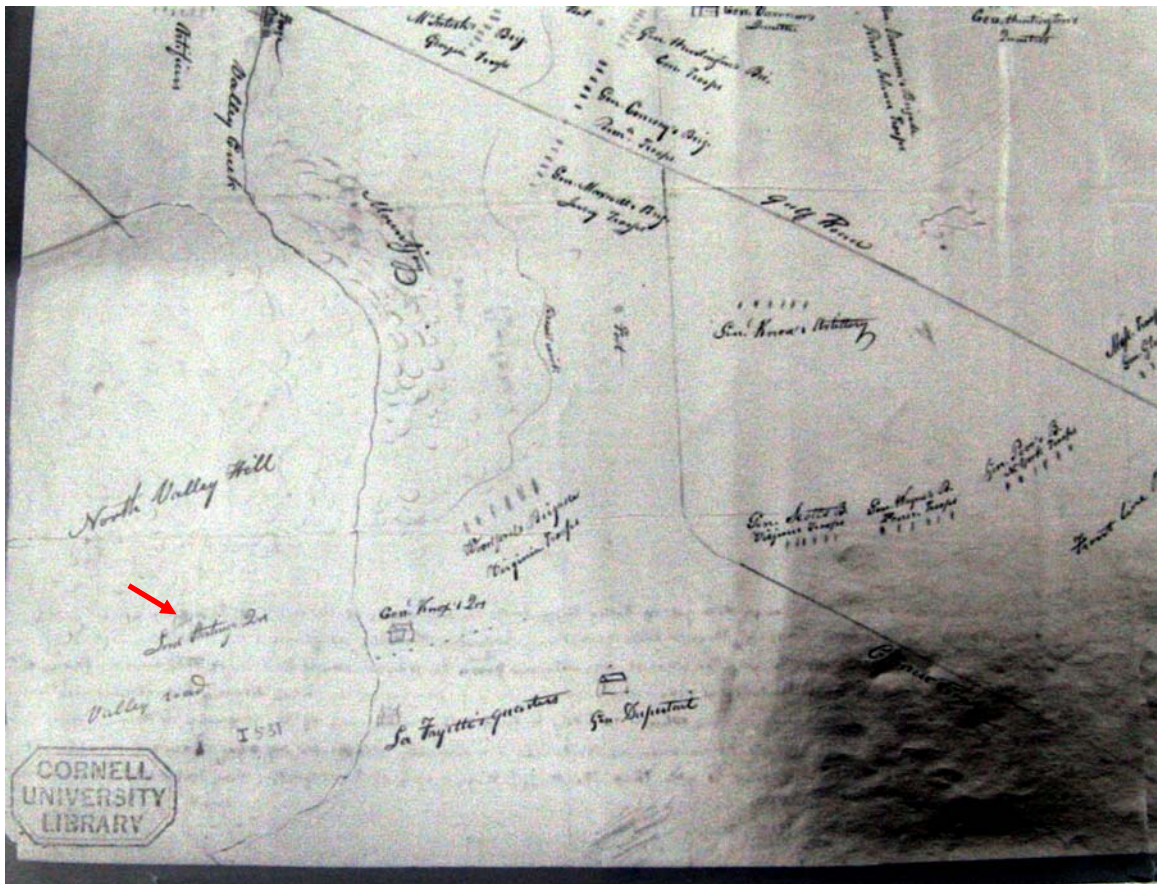
<sup>21</sup> In March of 1778, loyalist Joseph Galloway sent a copy of a spy map outlining the Valley Forge encampment, which he had obtained from a British spy, to the Earl of Dartmouth. The Galloway Spy Map, as it is known, shows the Valley Forge encampment at an early stage in its development. A copy of the Galloway Spy Map is located in the Map Collection of the Valley Forge National Historical Park Archives.

<sup>22</sup> The so-called Pennypacker Map is named for Samuel W. Pennypacker, Governor of Pennsylvania 1903-1907, who obtained the map on a trip to the Netherlands. Pennypacker attributed the map to a French Engineer. A copy of the Pennypacker Map is located in the Map Collection of the Valley Forge National Historical Park Archives. The original document is located in the Library of the Honorable Samuel W. Pennypacker.



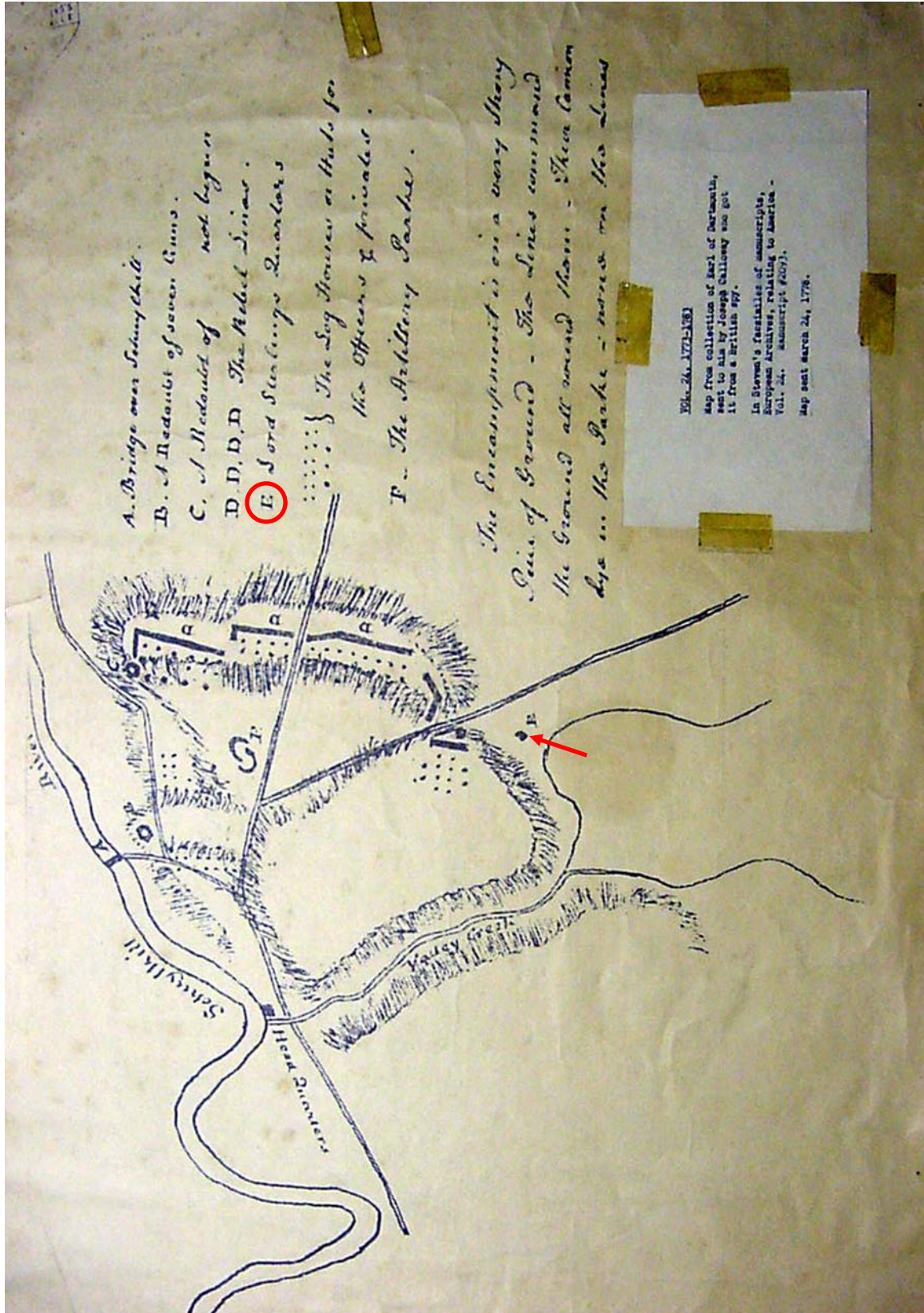
clandestine spy operations, the limited knowledge of the outlying territory at the time, and the relative skill of the cartographers - may have affected their accuracy. It is possible that the authors of these maps simply mistook the geography placing Stirling on the opposite side of the creek. It is also possible that Stirling was originally quartered elsewhere, as the Galloway Spy Map and the Pennypacker Map seem to indicate, and then moved to the Currie farm later.

Nevertheless, despite the lack of indisputable documentary evidence, it has been speculated, and subsequently established through oral history and tradition, that Lord Stirling spent at least part of the winter of 1778 quartered at the Currie house.



**Figure 3:** Detail from the Davis-Armstrong-Sparks Map showing "Lord Stirling's Qrs" in the general vicinity of the William Currie property on the west side of Valley Creek.





**Figure 4:** The Gallows Spy Map, sent to the Earl of Dartmouth on March 24, 1778, shows “Lord Stirling’s Quarters” south of camp on the east side of Valley Creek. (This image has been rotated 90°. True north is oriented to the left.)





**Figure 5:** The so-called “Pennypacker Map” showing “Lord Stirlings” south of camp on the east side of Valley Creek. (North is oriented to the right.)

## **1.2 CHRONOLOGY OF DEVELOPMENT & USE**



## 1.2 CHRONOLOGY OF DEVELOPMENT AND USE

Although both documentary and physical evidence suggests that construction of the existing buildings that currently comprise the Stirling's Quarters site did not take place until the second half of the 18<sup>th</sup> century and later, the early history of the property can be traced back to the original patents for two separate parcels of land dating to the early settlement of Chester County. Acting on behalf of William Penn, the Proprietaries Commissioners of Property granted 1340 acres by patent to David Meredith of the County of Chester in April 1706.<sup>23</sup> The property was acquired by David Powell of Philadelphia sometime later, possibly in November of the same year.<sup>24</sup> In 1714, David Powell sold 100 acres of this land to Henry Jones of the Great Valley.<sup>25</sup> The same 100 acres were in turn bequeathed to Henry's brother, Griffith Jones (otherwise Griffith John), in 1739, and then transferred to his son, Thomas Jones (otherwise Thomas John), in 1752.<sup>26</sup> In 1740, William Penn's sons, John Penn, Thomas Penn and Richard Penn, Esquires Proprietaries of Pennsylvania, granted a separate 176-acre parcel to Griffith John.<sup>27</sup> According to his Last Will and Testament, Griffith John later bequeathed the same parcel to his son, Thomas John, in 1753.<sup>28</sup>

In December 1764, Thomas John borrowed a sum of money by way of mortgage from Joseph Williams, a tanner, using his 176-acre parcel of land as collateral.<sup>29</sup> It appears that a separate loan transaction, or mortgage, was also made for the 100-acre lot. Thomas John's debts were apparently never repaid in full, and so upon his death in 1767, John Morton, Esquire, High Sheriff of the County of Chester seized the properties to settle debts owed by Thomas John to the estate of Joseph Williams. William Currie purchased both of these properties via sheriff's sales the same year.<sup>30</sup>

The 1767 deed description for the 176-acre parcel includes no mention of an existing dwelling on the property apart from the standard inclusion clause:

"All that certain Plantation Tract or Parcel of Land containing one Hundred seventy six Acres be the same more or less . . . Together with all and Singular the Houses Outhouses Edifices and Buildings thereon erected . . ."<sup>31</sup>

The deed description for the 100-acre parcel, however, does include the word "message" which may indicate that there was an existing dwelling on the property at the time of the sheriff's sale:

---

<sup>23</sup> Bureau of Land Records, Harrisburg, PA (microfilm), Pennsylvania Patent Book A, vol. 3, p. 270.

<sup>24</sup> The circumstances of this transaction are not clear. The recitation included in William Currie's 1791 deed to Thomas Walker (Book G2, Vol. 31, p. 53) refers to a patent from the Proprietaries Commissioners of Property to David Powell recorded the 16<sup>th</sup> of April 1706 in Patent Book A, Vol. 3, page 270 and following, which is actually the patent David Meredith received from William Penn. David Powell transfers 100 acres of this property to Henry Jones in 1714 (Book S, Vol. 18, p. 348). Consequently, David Powell must have acquired the land sometime after April 1706 and before December 1714. A map of early land transactions located at the Chester County Historical Society indicates that David Powell acquired the same 1340 acres on the 15<sup>th</sup> of November 1706. Reference sources for this transaction are not given.

<sup>25</sup> Chester County Deed Book S, Vol. 18, p. 348.

<sup>26</sup> Chester County Deed Book S, Vol. 18, pp. 349-350.

<sup>27</sup> Pennsylvania Patent Book A, vol. 10, p. 111.

<sup>28</sup> Griffith John, Last Will & Testament, Chester County Estate File No. 1510, Chester County Archives and Records, West Chester, PA.

<sup>29</sup> Chester County Deed Book O, Vol. 14, p. 43.

<sup>30</sup> Chester County Deed Book P, Vol. 15, p. 129; Chester County Deed Book P, Vol. 15, p. 132.

<sup>31</sup> Chester County Deed Book P, Vol. 15, p. 132.



"All that certain Message Plantation Tract or Parcel of Land . . . containing one hundred acres be the same more or less . . . Together with all and Singular the Houses Outhouses Edifices and Buildings thereon erected . . ."<sup>32</sup>

Although this suggests that there may have been a dwelling house already standing on the property when Currie acquired it through sheriff's sale, it is during William Currie's tenancy that the original portions of the existing house (main block and one-story kitchen to the west) are believed to have been constructed. The message referred to in the deed description, if extant when Currie acquired the property in 1767, most likely was an independent structure which had no relationship with the current house. Physical evidence also confirms that the main block and the kitchen were built simultaneously. Removal of segments of the exterior stucco at the south façade revealed no observable seams in the exterior masonry at the first-floor level, as would be expected if the two blocks were constructed separately. Inscriptions in the masonry at the southwest corner of what was the original kitchen (see Figure 6) and in the west gable end of the main block indicate that these sections, deemed to be the oldest portions of the house, were built concurrently circa 1769.<sup>33</sup>



**Figure 6:** Detail view of one of the corner stones at the southwest corner of original kitchen block with the inscription, "W C September 1769."

---

<sup>32</sup> Chester County Deed Book P, Vol. 15, p. 129.

<sup>33</sup> Archival photographs of the southeast corner of the building taken by Ken Block in April 1984 (VAFO #6372 & #6373) reveal five sets of initials "M.C," "R.C," "W.C," "R.C," and "I.C." Three of these sets of initials are currently exposed. At least two of the initial sets include associated dates of 1769. A stucco panel with the inscription "1769" is also located at the west gable end of the central block in a recess just below the current peak.

In October 1791, William Currie sold “All that certain Messuage or Tenement Plantation and tract of Land situate in Tredyffrin Township . . . containing by Estimation Two Hundred Acres be the same more or less” to Thomas Walker.<sup>35</sup> Thomas Walker was a farmer and dairyman, who had married William Currie’s granddaughter, Margaret Currie, in April 1789.<sup>36</sup> Federal Census Data records from 1790 for Tredyffrin Township in Chester County do not list William Currie, but Thomas Walker does appear in the inventory as the “Head of Family.” According to the 1790 census data (see Table 1), there were five persons total living in the house at that time: two free white males of sixteen years of age and upwards; two free white females (no ages given); and one other free person.<sup>37</sup> The Reverend Currie supposedly continued to live on the property with Thomas and Margaret (Currie) Walker and their family until his death in 1803.<sup>38</sup> It is

<b>Table 1:</b> Federal Census Data, 1790 – 1830 <sup>34</sup> Tredyffrin Township, Chester County, Pennsylvania Thomas Walker, Head of Family			
Census	Summary of Household		Total No. of Persons
	Males	Females	
1790	2 Free white males 16 years and up 1 Other free persons	2 Free white females	5
1800	3 Free white males under 10 years 2 Free white males 26 – 45 years*	1 Free white female 26 – 45 years	6
1810	2 Free white males under 10 years 1 Free white male 10 – 16 years 1 Free white male 16 – 26 years 1 Free white male 45 years and up 3 Other free persons	3 Free white females under 10 years 1 Free white female 10 – 16 years 1 Free white female 16 – 26 years 1 Free white female 26 – 45 years	14
1820	1 Free white male 10 – 16 years (1 Free white male 16 – 18 years) 2 Free white males 16 – 26 years 1 Free white male 45 years and up 1 Free colored male 14 – 26 years 2 Free colored males 26 – 45 years	1 Free white female under 10 years 1 Free white female 10 – 16 years 1 Free white female 16 – 26 years 1 Free white female 45 years and up	12
1830	1 Free white male under 5 1 Free white male 20 – 30 years 1 Free white male 30 – 40 years 1 Free white male 70 – 80 years 2 Free colored males 24 to 36 years	1 Free white female 15 – 20 years 3 Free white females 20 – 30 years 1 Free white female 50 – 60 years	11

<sup>34</sup> United States Census Office, Population Schedules of the First through Seventh Censuses of the United States, 1790-1850 (Washington, DC: National Archives Microfilm Publications, 1949-1965).

<sup>35</sup> Chester County Deed Book G2, Vol. 31, p. 53.

<sup>36</sup> William Currie and Thomas Walker, “Memorandum Book of the Reverend William Currie (1710-1803) from 1782 to c.1800 and his grandson-in-law, Thomas Walker of Tredyffrin Township, from c.1805-1821 (1838),” photocopy, Chester County Historical Society, West Chester, PA.

<sup>37</sup> United States Census Office, Population Schedules of the First Census of the United States, 1790 (Washington, DC: National Archives Microfilm Publications, 1965).

<sup>38</sup> Pleasants, *The History of Old St. David’s Church*, 159.



unclear, however, exactly where Currie lived out his days. Since he does not appear to be accounted for in the 1800 Federal Census as part of Thomas Walker's household (see Table 1), as he would have been approximately 80 years of age, he may have been residing with other relatives at the time of the census and also at the time of his death in 1803.

The 1798 United States Direct Tax, also known as the Glass Tax, provides valuable information regarding the composition of the property not long after Thomas Walker took possession from William Currie. According to the tax records, Thomas Walker owned and occupied a property in Tredyffrin Township, Chester County, which included a two-story stone dwelling house, a stone "Kitchen," and a stone "Milkhouse."<sup>40</sup> The property was comprised of approximately 199 acres and also featured a stone barn, stable, and "Waggon House." As part of the 1798 Direct Tax records, the dimensions of the existing dwellings and "outhouses appurtenant" were also provided (see Table 2).

The number of windows and the number of lights or panes of glass, which were used in determining the value of the property, were listed as well. The dimensions of the "Dwelling House" closely approximate the actual dimensions of the main block of the existing house, while the 1798 "Kitchen" dimensions are similar to the actual dimensions of what would have been the original 1-story west kitchen. According to the 1798 tax records, the house remained essentially as it had been constructed in 1769.

<b>Table 2:</b> 1798 U. S. Direct Tax <sup>39</sup> Tredyffrin Township, Chester County, PA Property of Thomas Walker			
<b>Structure</b>	<b>Dimension</b>	<b>Windows</b>	<b>Lights</b>
Dwelling House	30 by 21	6	12
		2	15
		1	6
		2	4
Kitchen	19 by 19		
Milkhouse	15 by 13		
Barn	46 by 20		
Stable	31 by 20		
Waggon House	29 by 20		

At least two (and possibly three) separate construction campaigns are likely to have taken place during Thomas Walker's tenure on the property.<sup>41</sup> The first significant change to the house involved raising the original kitchen block from 1 to 1½ stories. Although it is not clear exactly when this modification took place, it is reasonable to conjecture that the change occurred during the later part of the 18<sup>th</sup> century, and perhaps as early as 1790 (see Figure 7). After his marriage to Margaret Currie in 1789, Thomas Walker apparently relocated to the Currie house to begin a family and to take over farming operations on the property. Walker's arrival and the consequent need for additional space in the house may have been the impetus for the relatively modest expansion of the kitchen attic from 1 to 1½ stories at that time.

---






<sup>39</sup> See 1798 United States Direct Tax (Glass Tax), Chester County, Tredyffrin Township on microfilm at Chester County Historical Society, West Chester, PA.

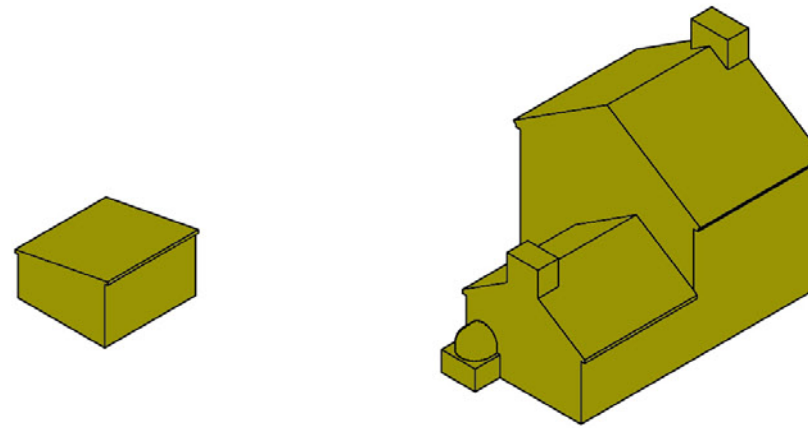
<sup>40</sup> Ibid.

<sup>41</sup> The barn situated to the south of Yellow Springs Road was also built by Thomas Walker circa 1803. It was later altered and expanded in 1926.

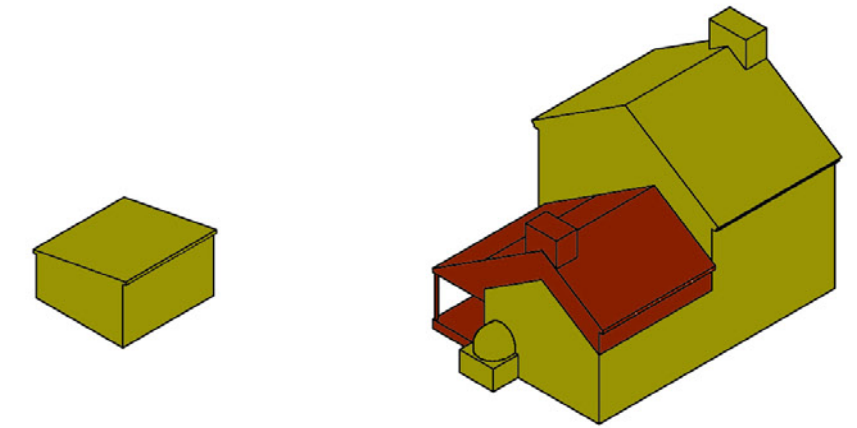
### CONSTRUCTION CHRONOLOGY

#### LEGEND

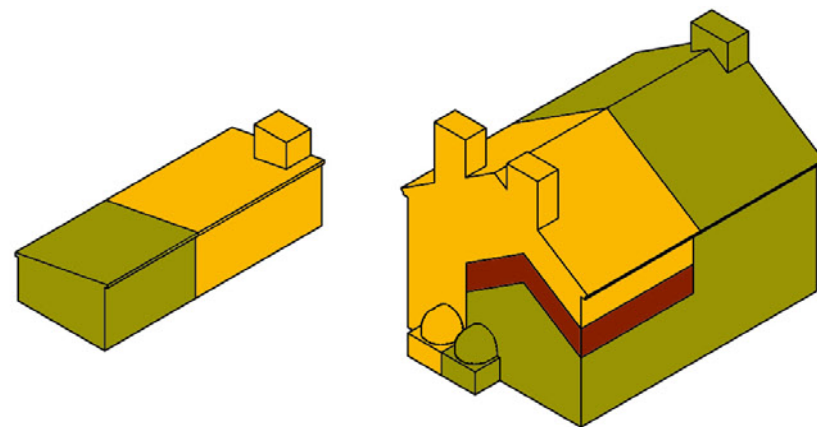
-  c. 1769
-  c. 1790
-  c. 1810
-  c. 1830
-  c. 1926



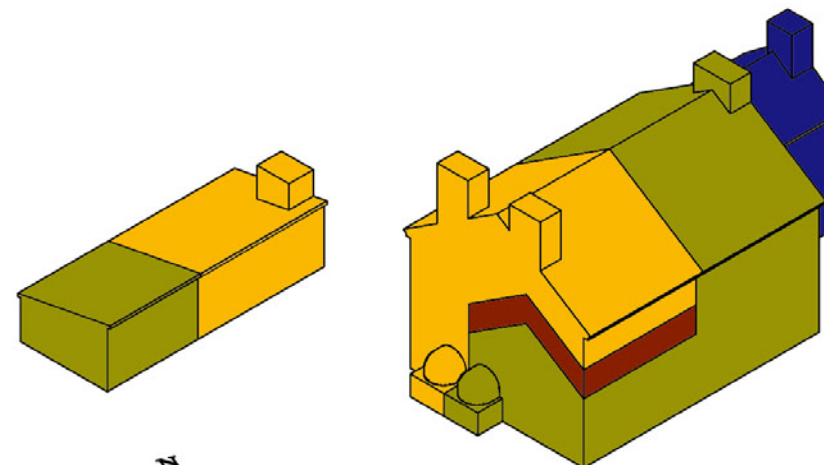
c. 1769



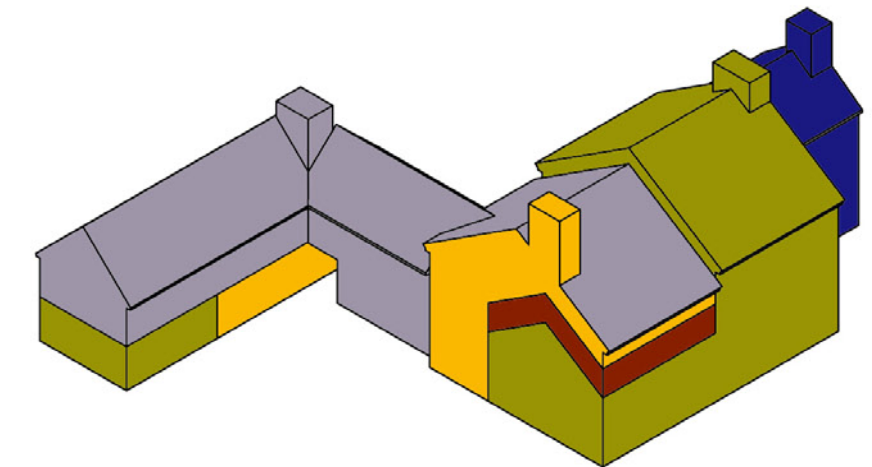
c. 1790



c. 1810



c. 1830



c. 1926

Figure 7: Isometric representation of general sequence of construction, c. 1769 – c. 1926.

The raising of the original kitchen block from 1 to 1½ stories is supported by a combination of existing physical evidence. A seam in the masonry between the main block and the kitchen, beginning at the second-floor level of the south elevation, indicates that the south exterior wall of the kitchen block was originally only 1 story in height and then subsequently raised. A recess in the exterior masonry of the west wall reveals a gable-shaped peak and evidence of mortar flashing on the opposite side of the chimney mass (inside the current attic) suggests that the roof was located at this intermediate height at one time, between the original 1-story and the current 2-story height. Investigation of the original north wall of the kitchen block also revealed cut-off joists and patched masonry beneath the second-floor floorboards where the original single-story wall had been raised to support the intermediate 1½-story roof configuration. The upper wall was removed during subsequent alterations (c. 1800-1820), exposing the evidence. The wood joists likely extended through the north wall to support a rafter plate that carried the original roof rafters at the north eave. The joists appear to have been chiseled within their masonry pockets. The masonry was then patched when the wall was raised to 1½ stories. A similar situation is likely to have existed at the south eave, but evidence would not be visible without dismantling the south wall.

Physical evidence also suggests that Thomas Walker significantly modified and expanded the kitchen block again sometime later. Federal Census Data records indicate a substantial increase in the Walker household circa 1810 (see Table 1). Several children appear to have been born to Thomas and Margaret Walker between 1800 and 1820, and according to the census figures, additional domestic help and farm hands were likely introduced as well. At about this same time, it is likely that the kitchen block, previously raised to 1½ stories, was further expanded to the north the full depth of the main block and raised to 2 full stories with an attic above to accommodate the increase in household members (see Figure 7). The new roof over the enlarged west kitchen block was made to be contiguous with the existing roof of the main block. The additional interior space included a second kitchen at the first floor to the north of the original kitchen and additional sleeping quarters at the second floor. The expansion also provided attic space above the west block as well. It is at this time that the additional ½ story on the original north wall was removed.

Construction of the east block appears to have occurred several years later, most likely circa 1830. A previous study of the building suggests that construction of the east addition and the expansion of the west block may have taken place at the same time, based on evidence that the single-hung wood windows in the east addition and the second floor windows (south elevation) of the west block match in their detailing.<sup>42</sup> While sash profiles and details do match, other physical evidence indicates that it is more likely that the west block was expanded c. 1810 and the second-floor windows of the west block were simply modified when the east addition was built c. 1830.

Thomas Walker lived on the property with his family until his death in 1839. According to his Last Will and Testament dated 1835, Thomas Walker bequeathed the property to his son, Joseph, but made certain provisions for the care and comfort of his wife following his death:

---

<sup>42</sup> John B. Dodd, "Classified Structure Field Inventory Report: Quarters of Major General William Alexander Lord Stirling," (September 1979), Valley Forge National Historical Park Library, Valley Forge, PA.

“... I give & bequeath to My Dear and loving Wife all my Household Kitchen & Seller Furniture silver Plate Chainy Clock & every sort whatsoever & also my Gigg and a good & gentle horse that she may go to meeting see our Children Friends &c and to occupy the Clock room the two rooms over it up stairs & the new Kitchen seller & up stairs & have the use of the Parlour when occasion would require . . .”<sup>43</sup>

Walker's direct reference to “the new Kitchen seller & up stairs” suggests that the 2-story east addition, comprised of a first-floor kitchen with cooking fireplace and bake oven (since removed), a second floor, and a cellar beneath was relatively “new” in 1835 at the time his will was composed. Thus, when the house passed by will to Thomas Walker's son, Joseph, in 1839, the main and west blocks of the house appeared as a single, uniform gabled mass with a smaller, but significant, addition to the east.

During William Currie's and Thomas Walker's tenures on the property and throughout much of the nineteenth century, the land surrounding the house appears to have been actively farmed and inhabited with livestock.<sup>44</sup> The surviving outbuildings and layout of the property also provide evidence of a once active farmstead. The springhouse/bakehouse to the north of the house and the small barn to the northeast appear to survive from the first part of the 19<sup>th</sup> century, if not earlier. Tax records from Currie's tenure indicate that he also owned cattle, horses, sheep and swine.<sup>45</sup> A Depredation Claim filed by William Currie in November of 1782 provides an accounting of the damages caused by the British Army in the fall of 1777 and portrays the Reverend Currie as a relatively well-to-do landowner with an active farm.<sup>46</sup> Federal Census Data for both the 1820 and 1840 censuses record seven persons living on the property “engaged in Agriculture.”<sup>47</sup> Thomas Walker's Estate Inventory from 1839 also includes an accounting of “Grain in the Granery,” “Grain in the ground,” “Grind-stone and Quarry tools,” “Indian Corn,” “Corn-sheller” and “Potatoes.”<sup>48</sup> At the time of his death in 1839, Walker's livestock included two cows, eight steers, two mares, and four shoats.

Thomas Walker's heir, Joseph B. Walker, also farmed the land. According to the 1850 Federal Census Data, he was a “Farmer” by occupation (see Table 3). Joseph died intestate in 1879.<sup>49</sup> The executors of the Walker estate sold the house with the

---

<sup>43</sup> Thomas Walker, Last Will & Testament, Chester County Estate File No. 9829, Chester County Archives and Records, West Chester, PA.

<sup>44</sup> See also Ann F. Rhoads, Douglas Ryan and Ella W. Aderman, “Land Use Study of Valley Forge National Historical Park,” (Philadelphia: Morris Arboretum of the University of Pennsylvania, 1989), 75-81.

<sup>45</sup> See Provincial Tax Records for Tredyffrin Township, Chester County, Chester County Archives, West Chester, PA.

<sup>46</sup> Apparently, on September 19, a company of British soldiers “from the Camp” came to Currie's house and “robbed” him of various goods and household items including all of his “Cabbage Bacon Cheese & Butter, a Bushel of fine salt & all my fine sheets Table Linen fine shirts head Dresses, Stocking, & Table Silver Spoons.” The next day a foraging party took several wagon loads of oats and wheat, as well as miscellaneous farming items and riding equipment. See Depredation Claim (15 November 1782), Tredyffrin Township, Chester County on microfilm at the Chester County Archives, West Chester, PA.

<sup>47</sup> United States Census Office, Population Schedules of the Fourth Census of the United States, 1820 and Population Schedules of the Sixth Census of the United States, 1840 (Washington, DC: National Archives Microfilm Publications, 1955-1958).

<sup>48</sup> Thomas Walker, Estate Inventory, Chester County Estate File No. 9829, Chester County Archives and Records, West Chester, PA.

<sup>49</sup> Obituaries and newspaper articles from the period indicate that Joseph B. Walker committed suicide on February 8, 1879. See newspaper clippings files in the collection of the Chester County Historical Society, West Chester, PA.

surrounding 163+ acres to Henry Evans in 1880. Nineteen years later, Henry Evans and his wife sold the property (totaling 130+ acres at that time) to Pedro Salom.

<b>Table 3:</b> Federal Census Data, 1840 – 1850 <sup>50</sup> Tredyffrin Township, Chester County, Pennsylvania Joseph B. Walker, Head of Family			
Census	Summary of Household		Total No. of Persons
	Males	Females	
1840	1 Free white male under 5 years 2 Free white males 5 – 10 years 1 Free white male 15 – 20 years 1 Free white male 30 – 40 years 2 Free white males 40 – 50 years	2 Free white females 15 – 20 years 1 Free white female 40 – 50 years 1 Free white female 60 – 70 years	11
1850	Joseph B. Walker, 51 years, Farmer William S. Walker, 20 years, Laborer Charles D. Walker, 17 years, Laborer Theodore M. Walker, 13 years Malachy Hine, 23 years (Ireland)	Hannah Walker, 51 years Margaret Walker, 77 years Elizabeth Stephens, 28 years Mary A. Mullin, 18 years (mulatto) Annie Myers, 8 years (black)	10

Although various changes to the house and grounds are likely to have occurred throughout Joseph Walker's 40-year ownership of the property and during both the Evans and Salom tenures, no documentation or physical evidence of significant alterations to the house during these periods have been identified to date.

Robert and Frances Ligget acquired the property from Pedro Salom in 1926. In an unpublished reminiscence and selected history of the Great Valley, Frances Ligget briefly described the house as they had found it in 1925:

“On one of our newly acquired farms the Reverend William Currie's quaint house was discovered to have been the quarters of William Alexander, Major General Lord Stirling during the encampment at Valley Forge, 1777-78. It was to this house that we came to live after necessary renovations. Deep in an atmosphere of the eighteenth century, it had been quite innocent of plumbing, electricity and other such new fangled nonsense.”<sup>51</sup>

The house and grounds underwent significant modification soon after the Liggets acquired the property. The architect of record for the renovations and additions was Boyle Irwin.<sup>52</sup> Irwin was a civil engineer and land surveyor by profession and a member of the American Society of Civil Engineers. According to his obituary, he was also interested “as an avocation . . . in the restoration of historical homes in Chester county, especially the Maj. General Sterling [sic] property and adjacent properties at Valley Forge.”<sup>53</sup> Frances Ligget described him as “an architect with an appreciative feeling for

<sup>50</sup> United States Census Office, Population Schedules of the Sixth through Seventh Censuses of the United States, 1840-1850 (Washington, DC: National Archives Microfilm Publications, 1955-1963).

<sup>51</sup> Frances H. Ligget, “Discovered - The Deep Country,” in “Great Valley Days,” (June 1965), 1.

<sup>52</sup> Frances H. Ligget, “History of Stirling's Quarters and the Property known as Echo Valley Farms, Valley Forge” in *Tredyffrin-Easttown History Club Quarterly* (October 1958), Vol. 10, No. 2, 39.

<sup>53</sup> *The Daily Local News*, West Chester, PA, 17 September 1945.

the colonial” who “added unobtrusively a wing over the spring house and bake house.”<sup>54</sup>

Detailed documentation and records of the 1926 renovations have not been located to date. Only three drawings of the proposed renovations as delineated by Boyle Irwin in February 1926 – including first and second floor plans and a south elevation – survive among the holdings of the Valley Forge National Historical Park Archives. The three archived drawings appear to be preliminary design documents, however, and are not necessarily a record of the as-built construction. They do provide some indication as to the extent of modifications made to the building and grounds at that time. The significant additions at the northwest end of the building including the additional level over the springhouse/bakehouse and the connecting link between the house and former outbuildings at the second floor are shown along with reconfigured interiors of the existing structures. A new kitchen and bathrooms were added along with plumbing, mechanical heating, and electricity.

In September 1979, a “Classified Structure Field Inventory Report” for Stirling’s Quarters was compiled by John Bruce Dodd.<sup>55</sup> Despite the lack of supporting documentation, Dodd was able to deduce and present a relatively thorough summary of the 1926 renovations. As part of his research, Dodd interviewed Mrs. Janet Irwin Malin, the daughter of Boyle Irwin. Mrs. Malin supposedly had accompanied her father on many visits to the house during the course of the work and “contributed much useful data regarding what remained in the structure before remodeling.” Correspondence between Dodd and Mrs. Ligget at the time also suggests that Mrs. Ligget was available to provide some firsthand knowledge as to the 1926 scope of renovations.

According to Dodd, the Liggets undertook a substantial construction campaign which included the entire northwest addition that extends over the springhouse/bakehouse, as well as various renovations to the existing structure and grounds. Interior renovations to the existing house included the introduction of a new kitchen (in Room 106), two second-floor bathrooms (in Rooms 203 & 207), and a first-floor powder room at the southwest corner of the original kitchen ell (Room 105). The size of the original cooking fireplace (in Room 104) was reduced to its current “parlor” configuration, and the cooking fireplace and chimney were removed entirely from the northern section of the west block (Rooms 106, 208 & 303). New faux-pegged oak flooring was introduced in several of the first-floor rooms and reproduction hardware for all of the doors was made from pieces found in the house. According to the Dodd Report, “all hardware in house was reproduced at forge owned by Wesley family in Pickering Station, PA, now known as Charlestown.”<sup>56</sup> A considerable amount of landscaping was also undertaken by the Liggets, including the construction of a stone retaining wall and a pergola connecting the springhouse/bakehouse with the small barn to the east.

During her occupancy, Frances Ligget was instrumental in the formation of the Penn’s Grant Chapter Colonial Dames XVII Century which received its charter on March 5, 1974. The first Chapter meetings were regularly held in the house and a plaque was

---

<sup>54</sup> Ligget, “Discovered – The Deep Country,” 1.

<sup>55</sup> See John B. Dodd, “Classified Structure Field Inventory Report: Quarters of Major General William Alexander Lord Stirling,” (September 1979), Valley Forge National Historical Park Library, Valley Forge, PA.

<sup>56</sup> *Ibid.*, 5.

presented by the Chapter to observe General Stirling's occupation of the property during the winter encampment at Valley Forge. The organization has continued their interest in Stirling's Quarters and has repeatedly provided financial support for the building's preservation and maintenance since 2004.

Stirling's Quarters was listed on the Pennsylvania Register of Historic Sites and Landmarks in October 1972. The property was also listed in the National Register of Historic Places in February 1974. In December 1975, a granite monument marker was dedicated on the property by the Pennsylvania Society of Sons of the Revolution to commemorate the quartering of Major General William Alexander, Lord Stirling and his Aide-de-Camp Major James Monroe in the home of Parson William Currie during the Valley Forge encampment of 1777-1778.

The property was transferred to Valley Forge National Historical Park in 1978. The building was initially used by the Park as quarters for seasonal workers. Various renovations were made to the building to accommodate this change in use, primarily involving updates to the plumbing, heating and bathroom facilities. In 2004, miscellaneous site drainage work and repairs to the exterior foundation walls were undertaken.<sup>57</sup> Prior to excavation, an archaeological study was conducted of the "proposed impact areas" including the basements and foundations of the building, as well as several selected locations surrounding the main house and outbuildings.<sup>58</sup> Preliminary analysis of the results indicated that the potential for additional significant archeological remains around the immediate perimeter of the house is minimal. Foundations of former bake ovens were identified, however, at both the east and west wings.

In the spring of 2005, the roofs of the house were reshingled as part of a general roof replacement project sponsored in part by a grant from the Save America's Treasures program. Deteriorated rake boards and cornices were also replaced along with gutters and downspouts.

---

<sup>57</sup> Construction Documents for Lord Stirling Quarters Hydrology Project prepared in December 2003 by Einhorn Yaffee Prescott, A&E, Albany, NY (Prime/Architecture and Engineering) and Clough Harbour & Associates, LLP, Albany, NY (Civil Engineering).

<sup>58</sup> John Milner Associates, Inc. with Skidmore, Owings, and Merrill, LLP, "Archeological Investigations, Stirling's Quarters (VAFO-348), Valley Forge National Historical Park: Preliminary Field Results," June 28, 2004.

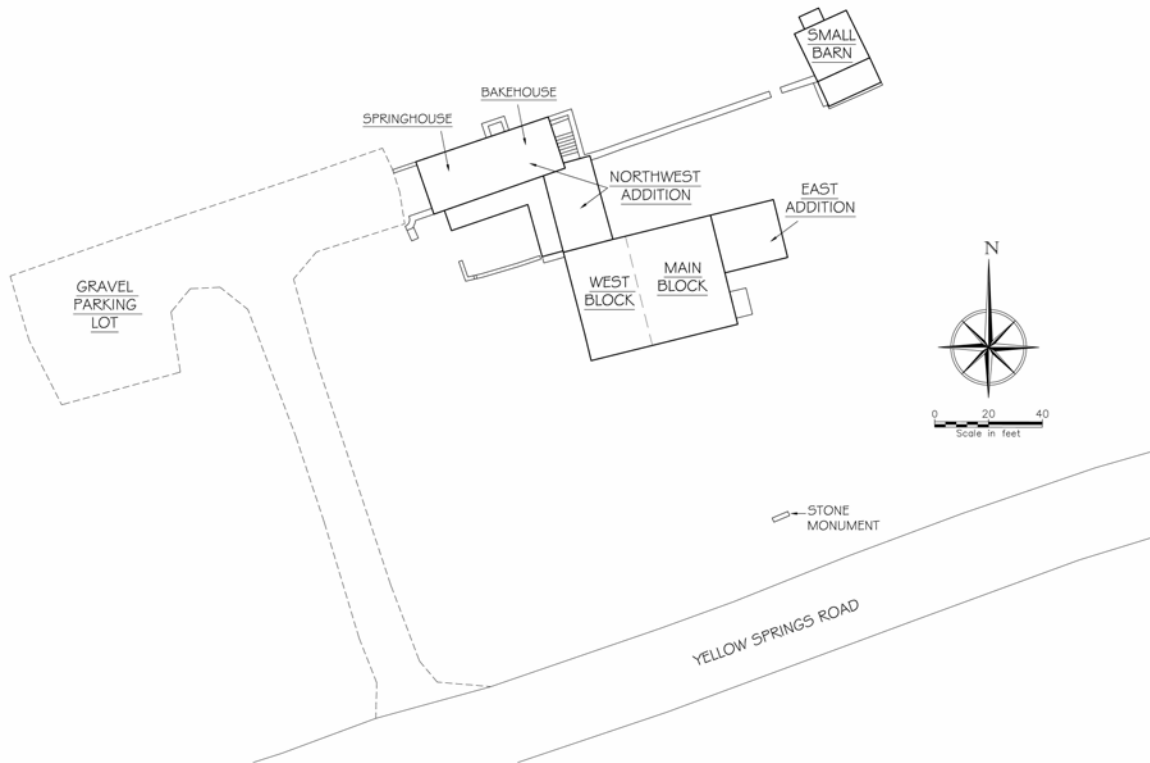


### 1.3 PHYSICAL DESCRIPTION



### 1.3 PHYSICAL DESCRIPTION

The property known as Stirling's Quarters is located in Tredyffrin Township, Chester County, Pennsylvania, about 1½ miles south of the Schuylkill River, just west of Valley Creek, within the boundaries of Valley Forge National Historical Park. The main house and associated outbuildings are sited facing south-southeast on the north side of Yellow Springs Road, to the west of the covered bridge that spans Valley Creek.<sup>59</sup>



Site Plan of Stirling's Quarters property showing main house and immediate vicinity.

The 2-story vernacular stone farmhouse that occupies the property is an amalgamated structure, constructed in at least four separate building campaigns dating from the 18<sup>th</sup> through 20<sup>th</sup> centuries. The house is comprised of four distinct sections: east addition, main block, west block (including the original kitchen), and the northwest addition (which incorporates the original springhouse and bakehouse structures). The plan of the house is roughly L-shaped with the original eighteenth-century sections and nineteenth-century additions forming the core length of the building. A twentieth-century addition projects from the rear of the west block to incorporate an eighteenth-century springhouse and nineteenth-century bakehouse located to the northwest of the house. A small two-story bank barn is situated behind the house to the northeast. A shallow retaining wall, approximately 2½ feet high, connects the east end of the former bake house with the small barn and defines a small courtyard to the rear of the main house.

---

<sup>59</sup> A large barn, also associated with the property but not included in the scope of this report, sits just across Yellow Springs Road to the southeast of the main house. It was built by Thomas Walker in 1803 and was later expanded to its current configuration in the 20<sup>th</sup> century.

The main (center) block of the house measures approximately 21'-10" wide (east-to-west) by 30'-10" deep (north-to-south). The original kitchen block is roughly square measuring approximately 20'-1" across each dimension. The extension to the north of the original kitchen adds another 11'-0" to the depth of the west block. The footprint of the first floor of the twentieth-century addition to the northwest is approximately 13'-11" wide by 15'-11" deep. The dimensions of the stone springhouse are approximately 16'-3" wide by 15'-5" deep, while the adjacent bakehouse is approximately 22'-4" wide by 15'-2" deep. The east addition is approximately 18'-1" wide by 16'-3" deep. The small barn located to the northeast of the main house measures approximately 15'-10" wide by 14'-9" deep not including the south porch.

The exterior walls of the main house and outbuildings are primarily load-bearing masonry constructed of local field stone. Only the second-floor of the twentieth-century northwest addition, including the section over the springhouse/bakehouse features wood frame construction with clapboard siding. Several campaigns of stucco plaster provide an exterior finish to most of the exterior masonry surfaces. All of the roofs of the building are comprised of replacement wood shingle systems.

## EXTERIOR ELEVATIONS

### South Façade -

#### Masonry

- The majority of the exterior walls of the south façade have been stuccoed except where pent and porch roofs were located. Several campaigns of stucco patching are evident across the entire façade. The material compositions of the stuccoes vary from a lime-based plaster (which represents the original or an early stucco application) to a hard cementitious plaster (typical of the most recent patching repairs).
- Sections of the stonework are visible where stucco is missing and in areas not previously stuccoed. The masonry is comprised of random rubble fieldstone. (Photo SEb)
- Pointing mortar samples taken from the main and west kitchen blocks are lime-based, pink/buff in color with well-graded and evenly distributed aggregate and high lime content. The profile and composition of the pointing mortar on these sections indicates that the masonry was intended to be exposed (i.e., not concealed by stucco).
- The east addition appears to have always been stuccoed, because no finished pointing was found on the stonework under the stucco.
- A stone flashing course projects slightly below the second-floor windows of the main block. The flashing course and the inferior quality rubble stonework in this area suggest that there was originally a pent roof across the south façade of the main block. (Note 1/SE)
- Archive photographs taken in 1984 record five (5) sets of initials at the southwest corner of the south façade. Several of these inscriptions were covered with stucco between 1984 and 1994; only three are currently exposed: one stone with the inscription "W. C. September 1769" and two stones with the inscription "R. C. 1769." (Note 2/SE) (Archive Photo 1)
- Stonework on the south wall at the juncture of the main block and the original kitchen (west block) is integrated at the first-floor level which supports the assertion that the two blocks were constructed concurrently. A vertical seam in the masonry does exist at the second-floor level, however, indicating that the original kitchen block was initially only 1 story and later raised. (Photo SEb, Note 3/SE)
- Small stone infill west of the main entrance door suggests that there may have been a stoop with a railing in the 18<sup>th</sup> century. However, similar evidence was not observed at the east side of the door. (Note 4/SE)

#### Roofs

- The south roofs of the house were repaired and re-surfaced with wood shingles in the spring of 2005.
- The roof over the west block was lowered approximately 2 feet as part of the 1926 renovations to the property. (Note 5/SE)
- A partially dismantled pent roof survives at the west kitchen block over the entrance door and first-floor window. Archive photographs show a roof in this location c. 1900. The current roof, however, was likely added as part of the 1926

renovations. Part of the pent was removed during architectural investigations of the building. (Archive Photos 2 - 4)

- A stone flashing course projects slightly below the second floor windows on the south façade of the main block, suggesting that there was originally a pent roof across this section. (Note 6/SE)
- There is currently a pent roof over the entrance to the east addition.

### Doors

- The wood frame at the entrance to the west block appears to be original; the door is a replacement. (Photo SEc)
- The wood frame and wood door at the entrance to the main block appear to be original.
- The wood frame and wood door at the entrance to the east addition are original to the construction of the east addition, c. 1830. (Photo SEd)

### Windows

- All of the south façade wood windows are weathered and deteriorated to some degree. Glazing putty has failed at most of the sash and exterior paint is generally worn. Wood sills and sash rails exhibit significant deterioration and rot.
- Window 001: 2-light awning window. The masonry opening appears to be original (c. 1830). The exterior grade has been raised.
- Window 002: 3-light awning window. The masonry opening appears to be original (1769).
- Window 003: 3-light awning window. The masonry opening appears to be original (1769).
- Window 101: 6/6 single-hung wood window. Profile and details are consistent with the original construction period of the east addition (c. 1830). (Photo SEe)
- Window 103: 9/6 single-hung wood window. Profile and details are consistent with the original construction period of the main block (c. 1769).
- Window 104: 9/6 single-hung wood window. Profile and details are consistent with the original construction period of the main block (c. 1769). (Photo SEf)
- Window 105: 8/8 single-hung wood window may have been modified in the 19<sup>th</sup> century, although interior plaster indicates that it was not modified (see description of Room 104). (Photo SEg, Note 6/SE)
- Window 201: 6/6 single-hung wood window. Profile and details are consistent with the original construction period of the east addition (c. 1830).
- Window 202: 6/6 single-hung, wood window. Appears to be original frame in original masonry opening (c. 1769).
- Window 203: 6/6 single-hung, wood window. Appears to be original frame in original masonry opening (c. 1769).
- Window 204: 6/6 single-hung, wood window. Appears to be original frame in original masonry opening (c. 1769). (Photo SEh)
- Window 205: 6/6 single-hung wood window. May date to c. 1810 at the time the west wing was expanded to a full two stories in height. (Photo SEi)
- Window 206: 6/6 single-hung wood window. May date to c. 1810 at the time the west wing was expanded to a full two stories in height.

Millwork

- The wood cornices were replaced as part of the roof replacement project in the spring of 2005.



Photo SEa – South façade, looking north.





**Photo SEb** - Partial view of south elevation masonry at juncture of main block and west block, looking north.

1. Seam in masonry at 2<sup>nd</sup>-floor level between west block and main block.
2. No seam in masonry at 1<sup>st</sup>-floor level between west block and main block.
3. Rubble fieldstone with lime-based pointing mortar is typical at main block and original kitchen block.





**Photo SEc** - Exterior view of door to west block, looking north. Wood frame appears to be original. Dutch door is a 20<sup>th</sup> century replacement.





**Photo SEd** – Exterior view of door to east addition, looking north. Wood door and frame appear to be original, c. 1830.



**Photo SEe** - Exterior view of Window 101, looking north.





**Photo SEf** - Exterior view of Window 104, looking north.



**Photo SEg** - Exterior view of Window 105, looking north.

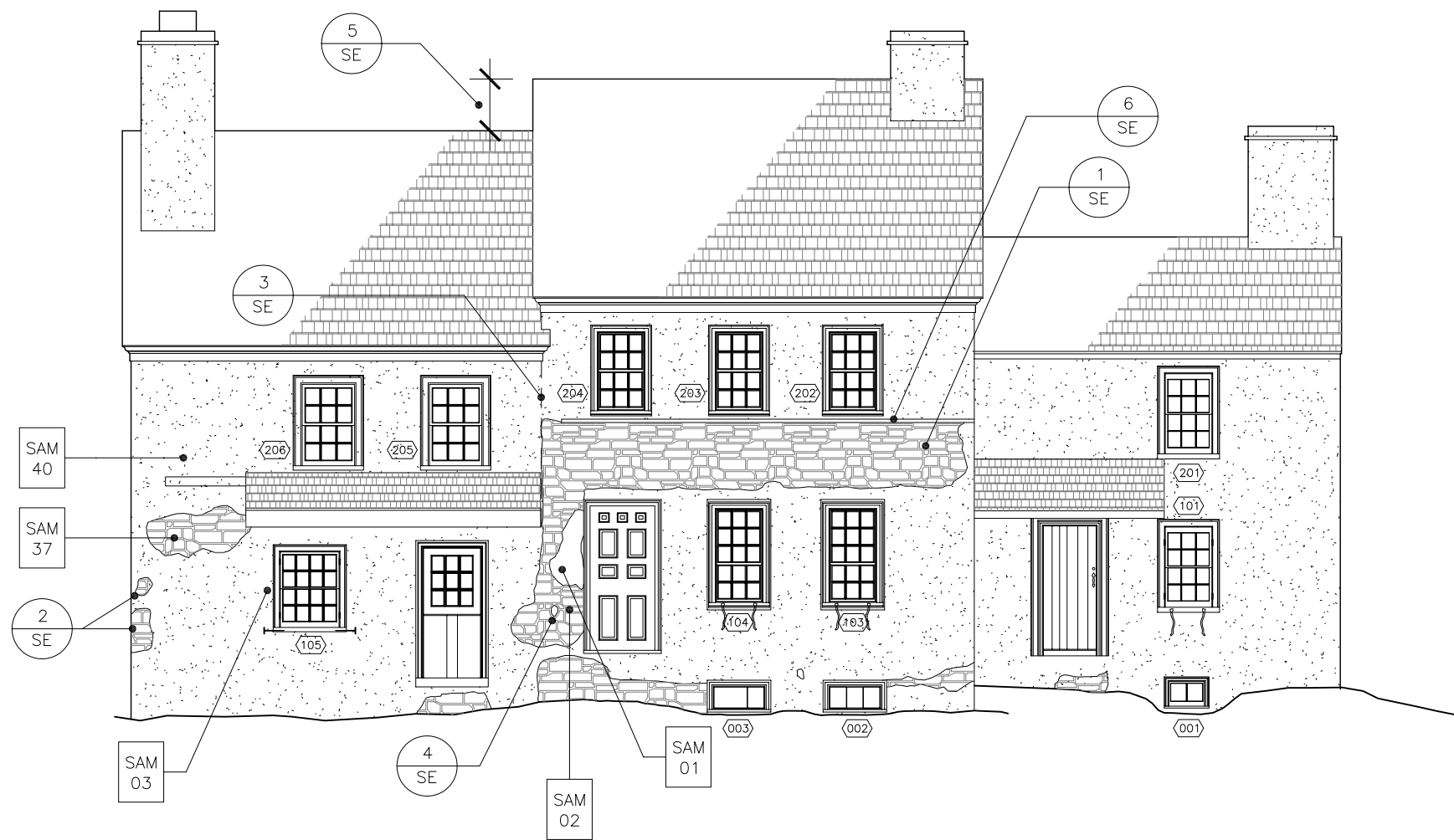




Photo SEh - Exterior view of Window 204, looking north.

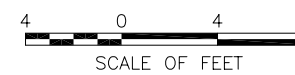


Photo SEi - Exterior view of Window 205, looking north.



**LEGEND:**

- NUMBER & DIRECTION OF PHOTO
- REFERENCE NOTE FROM DESCRIPTION NARRATIVE
- NUMBER & LOCATION OF MATERIAL SAMPLE



Historic Structure Report  
**STIRLING'S QUARTERS**  
 Valley Forge National Historical Park  
**JOHN MILNER ARCHITECTS, inc.**  
 104 Lakeview Drive, Chadds Ford, Pennsylvania 19317 • (610) 388-0111

PHYSICAL DESCRIPTION

SOUTH ELEVATION

## West Façade –

### Masonry

- The majority of the exterior walls of the west façade have been stuccoed. Several campaigns of stucco patching are evident across the entire façade. The material compositions of the stuccoes vary from a lime-based plaster (which appears to be an early stucco application) to a hard cementitious plaster (typical of the most recent patching repairs).
- Sections of the stonework are visible where stucco is missing. The masonry is comprised of random rubble fieldstone.
- A vertical seam in the masonry of the west block is evident beneath the exterior stucco. Examination of some of the exposed masonry at various locations along the seam indicates that the south section of the wall (original kitchen wall) preceded the construction of the north section of the wall. (Photo WEB, Note 1/WE)
- A recess in the masonry, about the width of the existing chimney mass, reveals what appears to be evidence of a gabled peak approximately 3 feet below the current roofline. The peak is understood to represent the intermediate roof height which was created when the kitchen block was raised from 1 to 1½ stories. (Note 2/WE)
- There is a recessed stuccoed panel in the west gable of the main block with the inscription “1769.” Material analysis of the stucco suggests the panel is contemporary with the pointing of the main and original kitchen blocks. (Photo WEc, Note 3/WE)
- There is evidence of a former bake oven in the masonry of the west wall of the original kitchen block where different stone was used to infill the former opening. Archeological investigations confirm the existence of a stone foundation likely for a bake oven at this location. (Photo WEf, Note 4/WE)
- There is also evidence of a former bake oven in the masonry of the west wall of the northwest addition where stone and brick were used to infill the former opening. Archeological investigations confirm the existence of a stone foundation likely for a bake oven at this location. (Photo WEf, Note 6/WE)

### Roofs

- The roofline of the west block was lowered to its current height as part of the 1926 renovations to the property.

### Chimneys

- There is a single chimney mass projecting from the south roof of the west block. The location of the chimney is consistent with the location of the original kitchen fireplace. The original chimney has been extended in height, however, as part of the various renovations to the house.
- A vertical crack to the south of Window 208 represents the location of a former chimney that was added when the west block was expanded to the north c. 1810. An archival photograph shows the chimney in place in 1902. The chimney was removed as part of the 1926 renovations. (Photo WEB, Note 5/WE) (Archive Photo 3)



### Windows

- Window 106: 6-light wood casement. Window added as part of the 1926 renovations. (Photo WEe, Note 6/WE)
- Window 107: 8/8 single-hung wood window. This window was added as part of the 1926 renovations which included the removal of a first-floor fireplace and associated chimney mass. (Note 7/WE)
- Window 112: This window was cut into the west wall of the springhouse sometime after initial construction.
- Window 207: pair of 6-light wood casements. Original masonry opening adapted to accommodate installation of replacement window in 1926. (Photo WEd, Note 8/WE)
- Window 208: 8/8 single-hung wood window. This window was added as part of the 1926 renovations which included the removal of a first-floor fireplace and associated chimney mass. (Note 9/WE)
- Window 303: 6-light wood sash set in modified wood frame. This window was initially configured as a typical 6/6 wood window as indicated in archival photograph. The masonry opening and window were adapted to their current configurations when the west block roof was lowered in 1926. (Note 10/WE)
- Windows 108, 109, 209, 210, 211, and 214 were added at the time of the c. 1926 renovations and northwest addition.

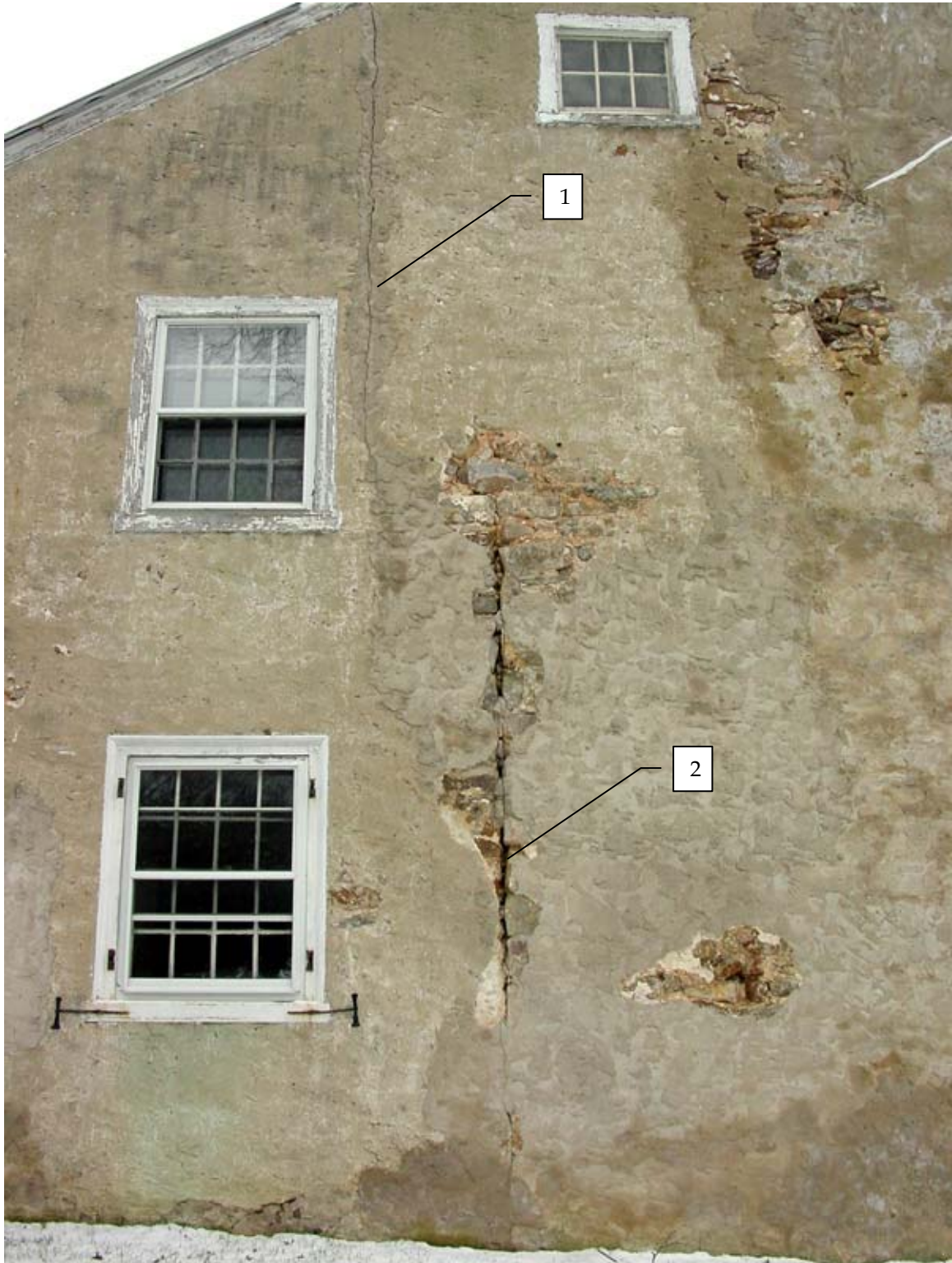
### Millwork

- The rake boards and cornice returns of the main and west blocks have been replaced as part of the roof repairs in the spring of 2005.



**Photo WEa** – West façade, looking east.





**Photo WEB** – Partial view of west elevation of west block, looking east.

1. Seam in masonry where c. 1810 chimney was removed during the c. 1926 renovations to the house. The first- and second-story windows (left) were added when the chimney and interior fireplace were removed, c. 1926.
2. Seam between original c. 1769 kitchen block (right) and c. 1810 addition to the north (left).





**Photo WEc** - Detail view of recessed stucco panel at west gable peak of main block, looking east. The inscription "1769" is faintly visible.

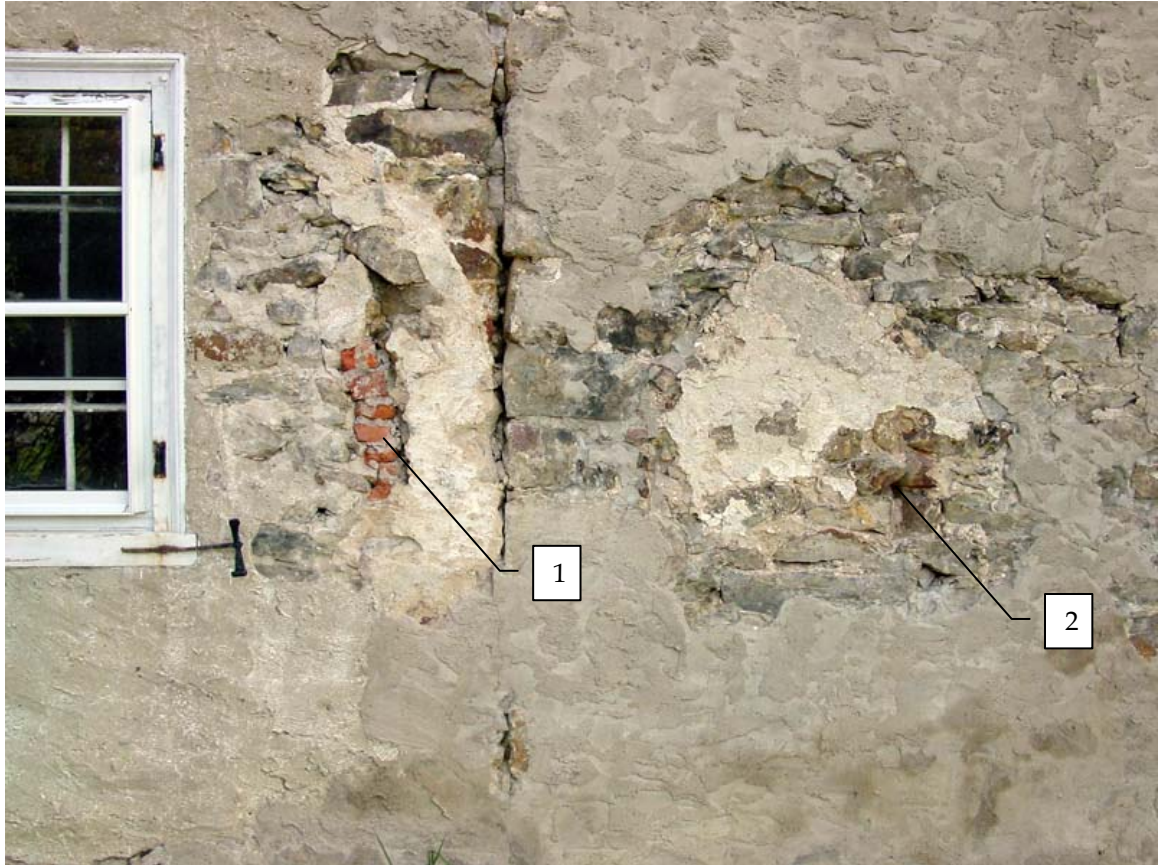


**Photo WEd** - Exterior view of Window 207, looking east.



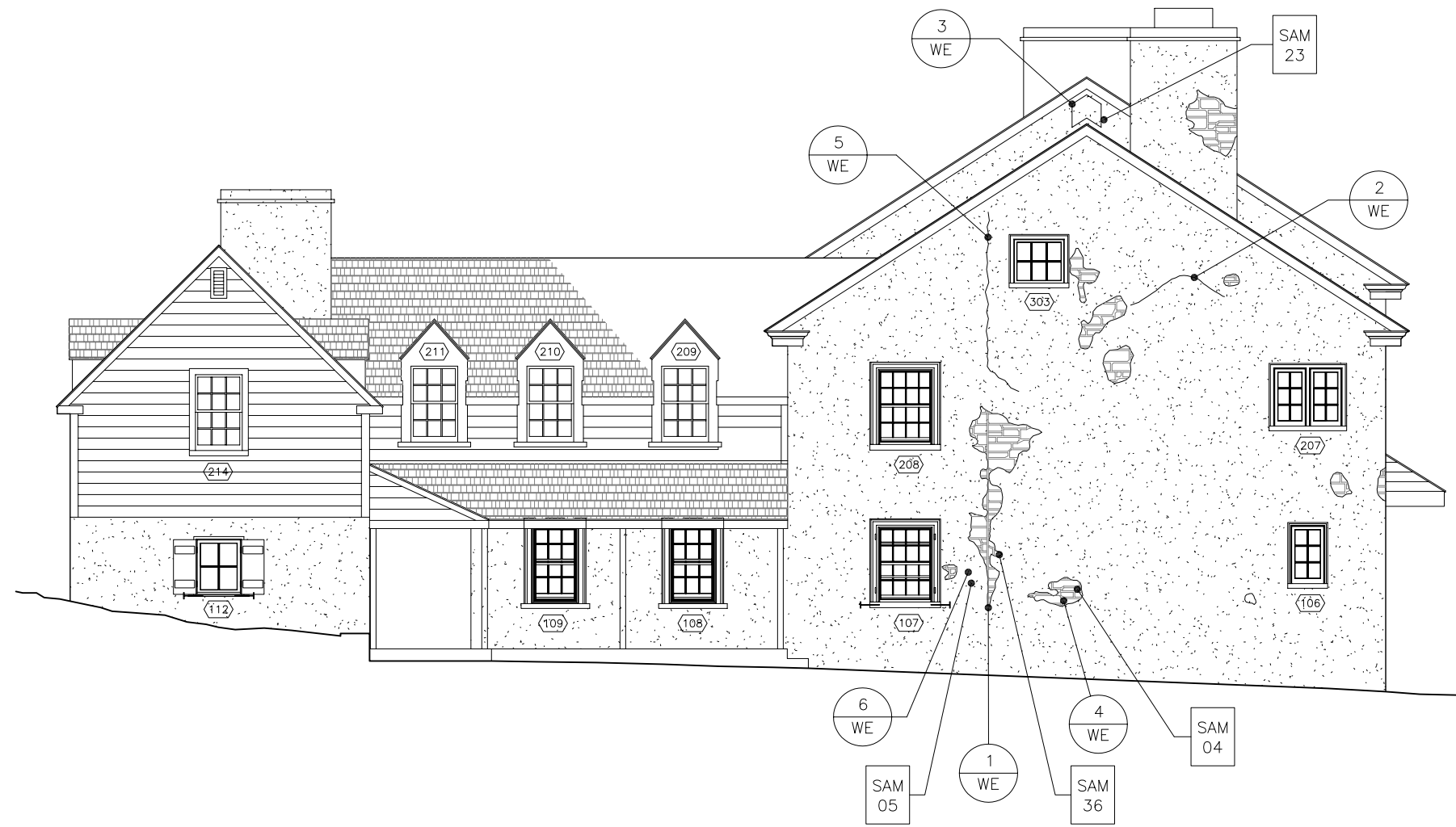


**Photo WEe** - Exterior view of Window 106, looking east.





**Photo WEf** - Detail view of seam between original c. 1769 kitchen block (right) and c. 1810 addition to the north (left), looking east.


1. Brick infill at location of former bake oven.
2. Masonry infill at location of former bake oven.




**LEGEND:**

NUMBER & DIRECTION OF PHOTO 

REFERENCE NOTE FROM DESCRIPTION NARRATIVE 

NUMBER & LOCATION OF MATERIAL SAMPLE 

  
SCALE OF FEET

Historic Structure Report  
**STIRLING'S QUARTERS**  
 Valley Forge National Historical Park  
**JOHN MILNER ARCHITECTS, inc.**  
 104 Lakeview Drive, Chadds Ford, Pennsylvania 19317 • (610) 388-0111

PHYSICAL DESCRIPTION

WEST ELEVATION

## North Façade -

### Masonry

- The majority of the exterior walls of the north façade have been stuccoed. Several campaigns of stucco patching are evident across the façade. The material compositions of the stuccoes vary from a lime-based plaster (which appears to be the original or an early stucco application) to a hard cementitious plaster (typical of the most recent patching repairs).
- Sections of the stonework are visible where stucco is missing. The masonry is comprised of random rubble fieldstone.
- A seam in the masonry is evident between the east addition and the main block, indicating that these sections of the house are not integrated and, therefore, were constructed during separate building campaigns. A stucco finish observed within the seam at the east exterior wall of the main block also indicates that the main block, or at least the east façade of the main block, was stuccoed prior to the construction of the east addition. (Photo NEd, Note 1/NE)
- A seam in the masonry is evident between the west block and the main block, indicating that these sections of the house are not integrated and, therefore, were constructed during separate building campaigns. Stucco is not visible within the seam which supports the theory that the main block was originally exposed stone. (Photo NEc, Note 2/NE)
- Dissimilar mortar and stucco compositions also suggest that the east addition, the main block, and the north extension of the west (original kitchen) block were all constructed at different times.
- Removal of a portion of stucco at the north façade of the east addition exposed a section of wood lath spanning the butt end of a massive wood member. Investigation revealed that the wood member is the lintel for the c. 1830 kitchen fireplace. It appears that the lath was installed to enable the exterior stucco to be applied over the pocket in the masonry formed by the installation of this lintel. (Photo Neb, Note 3/NE)

### Roofs

- The north roofs of the house were repaired and re-surfaced with wood shingles in the spring of 2005.
- The roof over the west block was lowered approximately 2 feet as part of the 1926 renovations to the property.
- There is a projecting shed roof over the entrance to the east addition.
- The east addition has pockets from a former pent roof or porch. (Note 4/NE)

### Doors

- The east door is original to the east addition (c. 1830).
- The west door was installed circa 1926.

### Windows

- Window 116: 8/8 single-hung wood window.
- Window 117: Stucco removal exposed a disturbed stone jamb with pieces of brick. Window was not originally in this location or was enlarged to 6/6. (Note 5/NE)



- Window 118: 6/6 single-hung wood window.
- Window 119: 6/6 single-hung wood window.
- Window 120: 6/6 single-hung, wood window.
- Window 220: 6/6 single-hung, wood window.
- Window 221: 6/6 single-hung, wood window. Window is not original. Investigation exposed disturbance in the stone opening and brick infill. (Note 6/NE)
- Window 222: 6/6 single-hung, wood window.
- Window 223: 6/6 single-hung, wood window.

Millwork

- The wood cornices were replaced as part of the roof replacement project in the spring of 2005.



Photo NEa - North façade, looking south.



**Photo NEb** - Detail view of lath at lintel pocket, north façade of east addition, looking south.

**Photo NEc** -  
Detail view of seam in masonry between main block (left) and west block (right). The pointing mortar of west block extends into the seam along west side of the masonry wall. There is no evidence of stucco at the west side of the main block. View represents the general location of Material Sample 32.










**Photo NEd** - Detail view of seam at north elevation between main block (right) and east addition (left), looking south. Note textured surface of stucco and that stucco wraps around east side of the main block. View represents the general location of Material Sample 26.




**LEGEND:**

NUMBER & DIRECTION OF PHOTO 

REFERENCE NOTE FROM DESCRIPTION NARRATIVE 

NUMBER & LOCATION OF MATERIAL SAMPLE 

  
SCALE OF FEET

Historic Structure Report  
**STIRLING'S QUARTERS**  
 Valley Forge National Historical Park

**JOHN MILNER ARCHITECTS, inc.**  
 104 Lakeview Drive, Chadds Ford, Pennsylvania 19317 • (610) 388-0111

PHYSICAL DESCRIPTION

NORTH ELEVATION

## East Façade –

### Masonry

- The majority of the exterior walls of the east façade have been stuccoed. Several campaigns of stucco patching are evident across the façade. The material compositions of the stuccoes vary from a lime-based plaster (which appears to be the original or an early stucco application) to a hard cementitious plaster (typical of the most recent patching repairs).
- Evidence of stucco on the east façade of the main block behind the roof rafters of the east addition indicates that the east façade of the main block was stuccoed prior to the construction of the east addition (c. 1830). The east wall of the main block may have been stuccoed along with the rest of the building after the west block was expanded circa 1810. It may also have been stuccoed prior to the west expansion and as early as the original construction period of 1769, as it was not uncommon for the east façade of an otherwise exposed masonry building to be stuccoed to protect against driving rains and harsh weather from the east. (Photo EEb)
- Sections of the stonework are visible where stucco is missing. The masonry is comprised of random rubble fieldstone.
- Evidence of a bake oven is visible on the east addition. (Note 1/EE)
- The northern section of the bakehouse is not constructed of masonry. It is wood framed with a stucco exterior. (Note 6/EE)

### Roofs

- The north roofs of the house were repaired and re-surfaced with wood shingles in the spring of 2005.

### Chimneys

- There is a single chimney mass projecting from the center of the east addition. The location of the chimney is consistent with the location of the original c. 1830 kitchen fireplace (Room 101).
- There is a single chimney mass projecting from the center of the main block. The location of the chimney is consistent with the location of the original 1769 corner fireplaces (in Rooms 102, 103 and 205).

### Door

- The cellar entrance doors are not original.

### Windows

- Window 102: 9/6 single-hung wood window. Based on the molding profiles and the construction of the window, Window 102 does not appear to be original to the main block. Archival photographs do not show a window at this location. Window 102 was likely added as part of the 1926 renovations to replicate the existing windows at the south façade of the main block (Windows 103 and 104). (Photo EEd, Note 3/EE) (Archive Photos 2 & 4)
- Window 301: 4-light wood window. This window appears to be original to the east addition (c. 1830).



- Window 302: 4-light wood window. This window opening appears to be original to the main block. The frame has holes in the jambs which may be from louver slats. A 4-light sash has been retrofitted into the frame. (Photo EEE)
- A window opening similar to Window 302, symmetrically located on the opposite side of the east wall of the main block, was concealed when the east addition was constructed circa 1830. Examination of the east wall of the main block during the reroofing of the east addition in the spring of 2005 indicated that the early lime-based stucco that covered the east wall also wrapped inside the jamb reveals of the attic windows as evidenced by a small segment of early lime-based stucco at the north jamb of this former masonry opening. (Photo EEC, Note 5/EE)

#### Millwork

- The rake boards and cornice returns of the main block and east addition have been replaced as part of the roof repairs in the spring of 2005. (Note 4/EE)

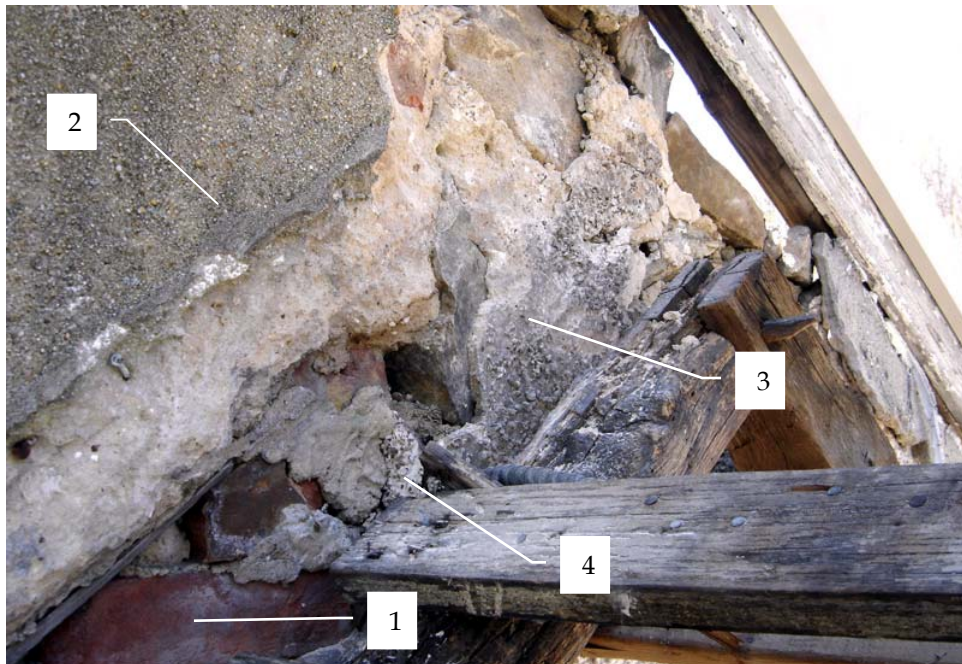


Photo EEa – East façade, looking west.





**Photo EEb** – Oblique view of east exterior wall of main block, looking northwest at location of east roof peak. Note that early lime-based stucco extends behind the east roof rafters. (East roof was removed at the time of this photo.) View represents the general location of Material Sample 14.



**Photo EEc** – Detail view of portion of former masonry opening at east exterior wall of main block, north end behind existing roof rafter, looking west. (East roof was removed at the time of this photo.)

1. Former masonry opening infilled with brick.
2. Cement-based, 20<sup>th</sup>-century exterior stucco application.
3. Early lime-based stucco application on masonry wall.
4. Early lime-based stucco application at north jamb of former opening.





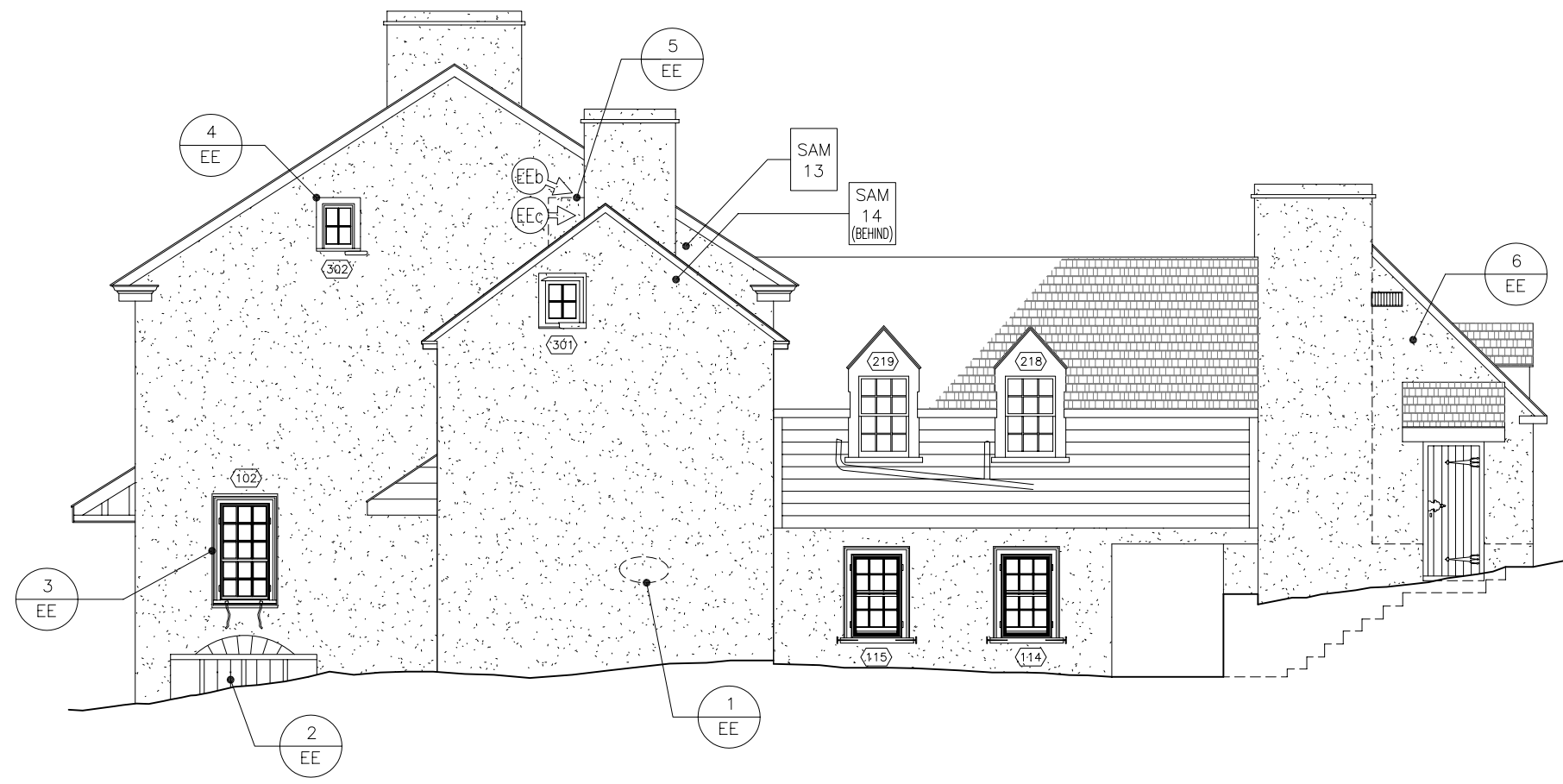
**Photo EEd** - Exterior view of Window 102, looking west.

1. Brick infill at north jamb.





**Photo EEe** – Exterior view of Window 302, looking west.



**LEGEND:**

- NUMBER & DIRECTION OF PHOTO
- REFERENCE NOTE FROM DESCRIPTION NARRATIVE
- NUMBER & LOCATION OF MATERIAL SAMPLE



Historic Structure Report  
**STIRLING'S QUARTERS**  
 Valley Forge National Historical Park  
**JOHN MILNER ARCHITECTS, inc.**  
 104 Lakeview Drive, Chadds Ford, Pennsylvania 19317 • (610) 388-0111

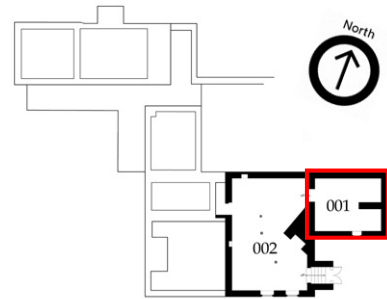
PHYSICAL DESCRIPTION

EAST ELEVATION

## INTERIOR SPACES

### Room 001 -

Room 001 is the basement of the east addition of the house which is believed to have been constructed by Thomas Walker circa 1830.



### Floor

- Concrete floor was installed by the Park as part of the site and building drainage control project.

### South Wall

- The impression from the original winder stair to the first floor can be seen to the east of the window near the floor. (Note 1/001)

### East Wall

- The impression from the original winder stair to the first floor can be seen to the south of the fireplace vault and on the south wall of the vault. (Photo 001a, Note 1/001)
- There is a 20<sup>th</sup>-century concrete lintel to support the fireplace hearth. The original hearth support was most likely stone.

### North Wall

- The north wall stone abuts the west wall of the main block. The west wall stone continues behind the north wall stone indicating that the east addition was constructed after the main block. (Note 2/001)

### West Wall

- Similar to what can be seen from the main block basement, the rough character of the stonework at the passageway to the basement of the main block suggests that the opening was introduced after the original foundation construction of 1769; most likely at the time of the c. 1830 addition. (Photo 001b, Note 3/001)



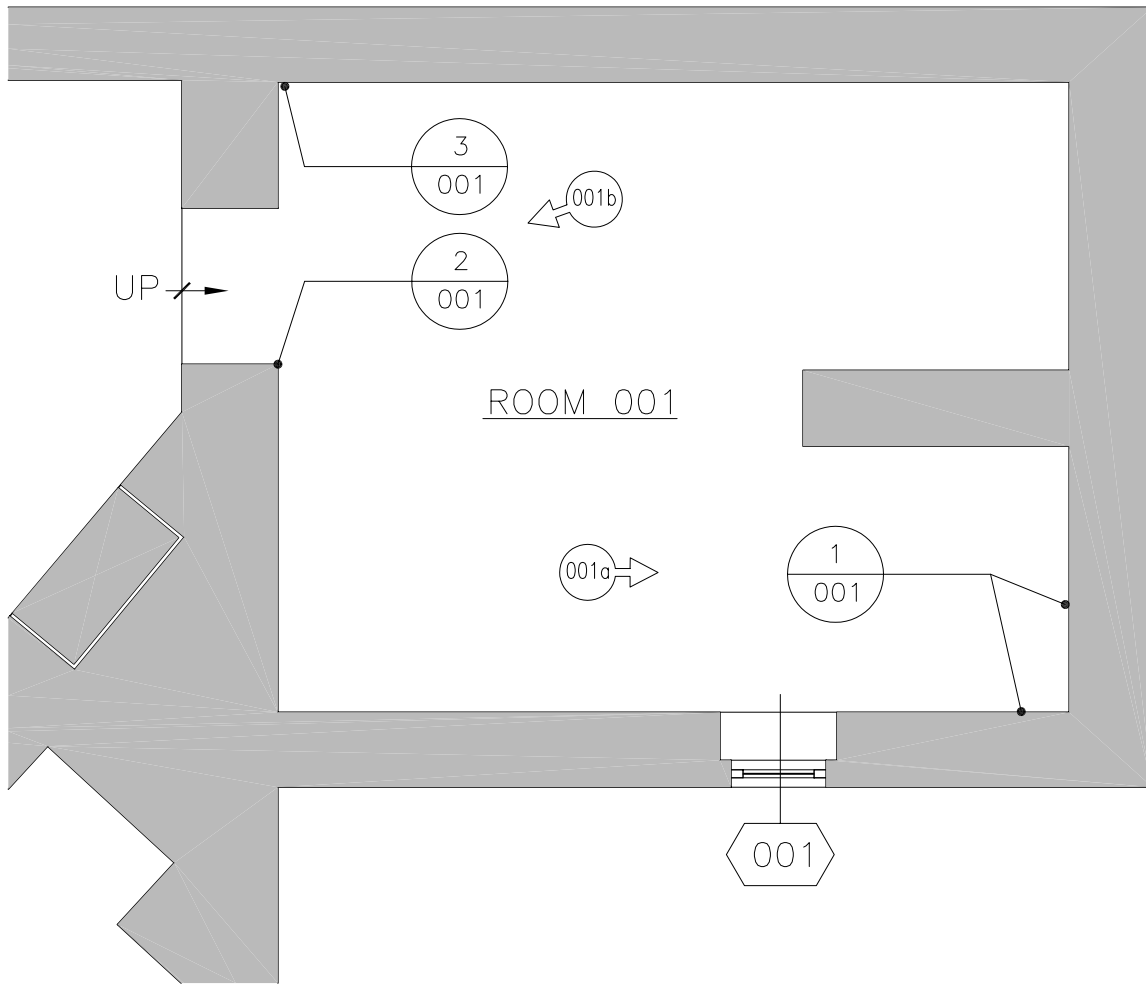
**Photo 001a** - View of segment of east wall to the south of the chimney vault, Room 001, looking east.

1. Evidence in plaster of former winder stair.










**Photo 001b** - Masonry opening between Rooms 001 and 002, looking west. Rough character of stonework suggests that the opening was added after original construction. This opening was likely formed at the time of the east addition, c.1830.



**LEGEND:**


 NUMBER & DIRECTION OF PHOTO   
 NOTE FROM DESCRIPTION NARRATIVE   
 MATERIAL SAMPLE LOCATION 

  
 SCALE OF FEET

Historic Structure Report

**STIRLING'S QUARTERS**

Valley Forge National Historical Park

**JOHN MILNER ARCHITECTS, inc.**

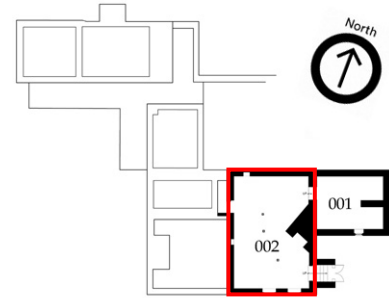
104 Lakeview Drive, Chadds Ford, Pennsylvania 19317 • (610) 388-0111

**PHYSICAL DESCRIPTION**

**ROOM 001**

### Room 002 -

The basement of the main block dates to the original construction period of 1769.



### Floor

- Concrete floor was installed by the Park as part of the site and building drainage control project.

### Ceiling

- The main block winder stair originally extended to the basement. The header for the stair opening is still in place although the joists are currently supported by a post and short beam due to deterioration. The stair opening was infilled with wide floor boards.
- The ceiling north of, and including, the summer beam has been replaced (except for the stair header noted above). The summer beam has no mortises and the joists are supported by ledgers nailed to the side of the summer beam. This work is presumed to have been completed by the Ligget family in 1926 or at the time that they replaced the floor boards above.

### South Wall

- Masonry window openings appear to be original to the building. The window frames and sash do not appear to be original. Most likely these openings originally had a wood frame with wood bars since the Glass Tax of 1798 does not indicate any type of window that could have been located in the basement.

### East Wall

- The rough character of the stonework at the passageway to the basement of the 19<sup>th</sup>-century addition suggests that it was put in later, probably at the time of the addition, c. 1830. (Note 1/002)
- The stone fireplace foundations are fully keyed into the exterior wall and are original to the main block construction in 1769.
- The north fireplace foundation arch has been infilled with stone. This is probably related to the boiler flue installation. (Photo 002a, Note 5/102)

### North Wall

- An opening on the north wall has been infilled with brick around several mechanical pipes. The jagged edges of the opening suggest that it was not original to the building (c. 1769) but cut into the wall at a later date. The area below this infill appears to be an early wall niche and the ledge on the right and left may have supported a wood lintel. (Photo 002b, Note 2/002)

West Wall

- The opening into the crawl space under the original kitchen may be an original wall niche that was altered to provide crawl space access. Pointing around the wood lintel is recent as well as the pointing in the stonework above. (Photo 002c, Note 3/002)
- The opening in the wall into a stone areaway was added in 1926 as access to a “new” winder stair up to Room 106 which was used as a kitchen by the Liggett family. Most likely they needed to add this stair since they were removing the two interior winder stairs and would not have otherwise had interior access to the basement. (Photo 002d, Note 4/002)



**Photo 002a** – Detail view of north fireplace foundation arch, Room 002, looking southeast. Alcove beneath arch has been infilled with stone and an exhaust flue from the current heating system has been introduced.





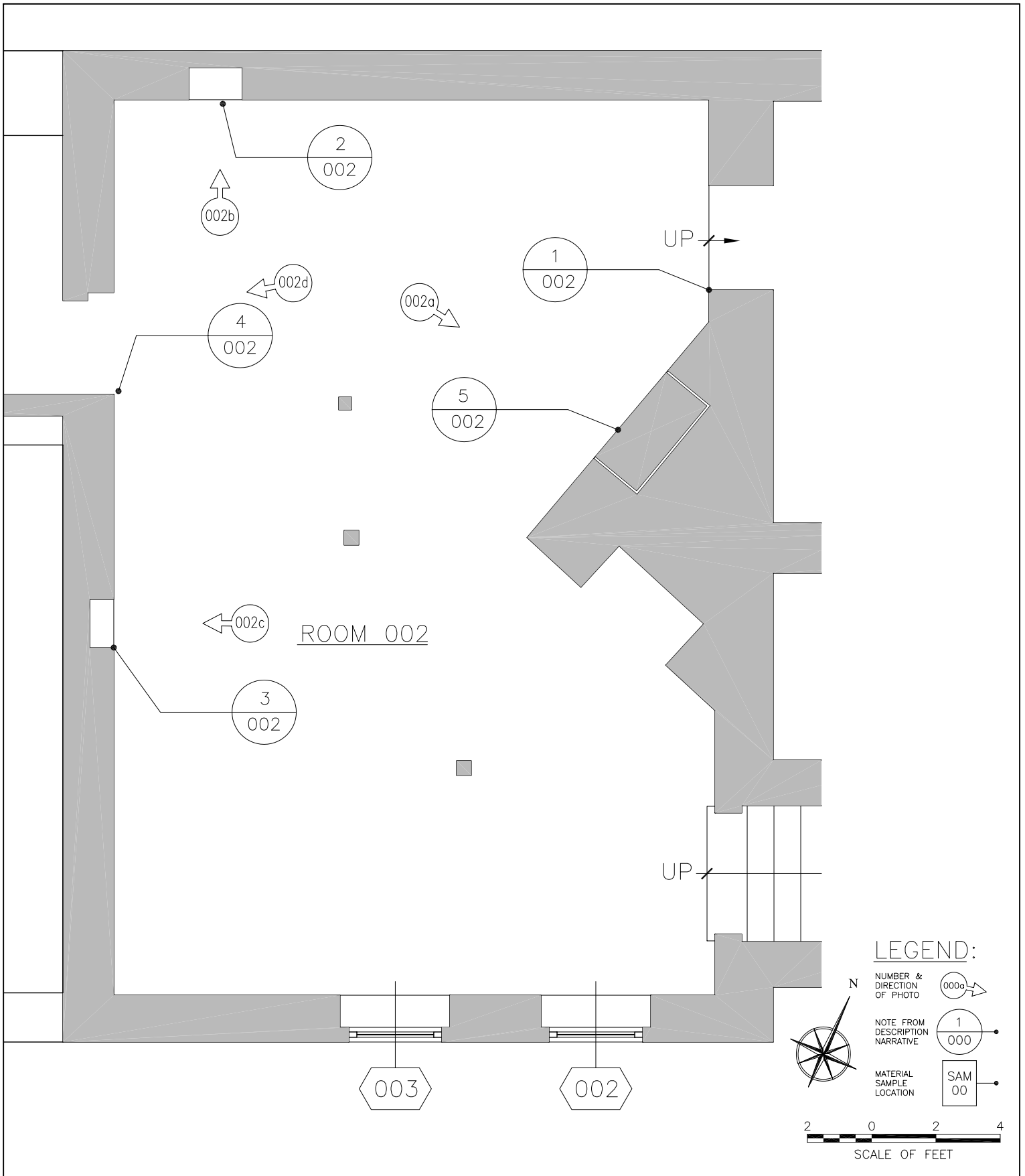
**Photo 002b** - Former masonry opening and niche at north wall, Room 002, looking north.



**Photo 002c** - Former masonry opening at west wall, Room 002, looking west.



**Photo 002d** - Masonry opening at west wall, Room 002, looking west, into areaway for stair to Room 106. This opening was likely added as part of the c. 1926 alterations to the house to enable access to the basement from the first-floor kitchen.



	<p style="text-align: center;">Historic Structure Report  <b>STIRLING'S QUARTERS</b>          Valley Forge National Historical Park</p> <p style="text-align: center;"><b>JOHN MILNER ARCHITECTS, inc.</b>          104 Lakeview Drive, Chadds Ford, Pennsylvania 19317 • (610) 388-0111</p>	<p style="text-align: center;"><b>PHYSICAL DESCRIPTION</b></p>	<p style="text-align: center;"><b>ROOM 002</b></p>
--	--	--	--

### Room 101 -

Room 101 is located in the east addition of the house which is believed to have been constructed by Thomas Walker circa 1830. There is a cooking fireplace along the east wall and winder stair at the southeast corner of the room.



### Floor

- Only fragments at the room edges remain of two layers of random width floor boards.
- Bottom layer of flooring ran east-to-west. The top layer runs north-to-south.
- Similarity of the room floor boards and the closet floor boards, where a winder stair was removed, suggest that the flooring was installed when the stair was removed. In addition, the fragments of the subfloor show that they are narrow beaded boards indicative of a later period than c. 1830. (Note 1/101)
- Existing floor joists are severely deteriorated.

### Walls & Baseboards

- All walls have two layers of plaster. The top layer is a thin finish coat; probably added in the 20<sup>th</sup> century.
- The c. 1830 plaster stops 1¼" below the ceiling joists and the top edge is slightly curved indicating that there was originally a plaster ceiling. (Photo 101a)
- Most of the wood baseboards on the north and south walls have been removed for the installation of baseboard radiators. The backing insulation for the radiators remains on the walls.
- The baseboard on the west wall has been applied over the second layer of plaster. In addition, the height of the present baseboard does not match the line in the original plaster indicating a 5¾" original c. 1830 baseboard height.

### Ceiling

- Ceiling is exposed wood joists with the beaded second-floor boards visible above.
- Undersides of ceiling joists have nail holes suggesting an earlier lath and plaster ceiling which is further supported by the plaster line on the wall. Majority of nail holes are square in shape indicating the use of cut nails.
- Joists have been cleaned and refinished which may explain the lack of plaster marks on the underside.

### Doors

- Room contains two doors on the east wall. One leads to the winder stair up to the second floor. The other is currently a closet door, but originally led to the basement winder stair. (Photo 101b)
- North and south walls each have an exterior wood door. Frames and doors appear original to the date of the east addition and the original wall plaster butts to the edge of the door trim.



- West wall doorway has c. 1830s molding around the opening. This doorway was created for access from the main block to the addition.
- Stair and closet doors have HL hinges mounted with a mixture of reproduction rose head nails and screws. Hinges and lift bars appear to be later replacements, most likely by the Liggett family. There are filled holes in both doors which seem to be from original hardware. The winder stair door also has four butt hinge mortises that have been filled with wood Dutchman patches. (Note 2/101)

#### Windows

- Window 101: 6/6 single-hung wood window. Profiles and details are consistent with the original construction period of the east addition (c. 1830). There is a hole in the plaster on both sides of the window sill which suggest that there may have been a different sill when the room was first plastered. However, all other c. 1830 plaster abuts the existing trim.
- Window 120: 6/6 single-hung, wood window with built-in drawer below. The drawer element may have been added later, perhaps with a sill replacement, since the sill has only one paint layer compared to many layers on the other window components. However, the base layer of plaster abuts all of the window trim including the drawer and apron. Left side of window sill has a hole in the plaster.

#### Stair

- Winder stair treads are plastered into wall. Flat head, cut nails are in the stair treads.
- Wood grab bar in stair has been added. The two parts are nailed together with wire nails and it is failing at this connection.

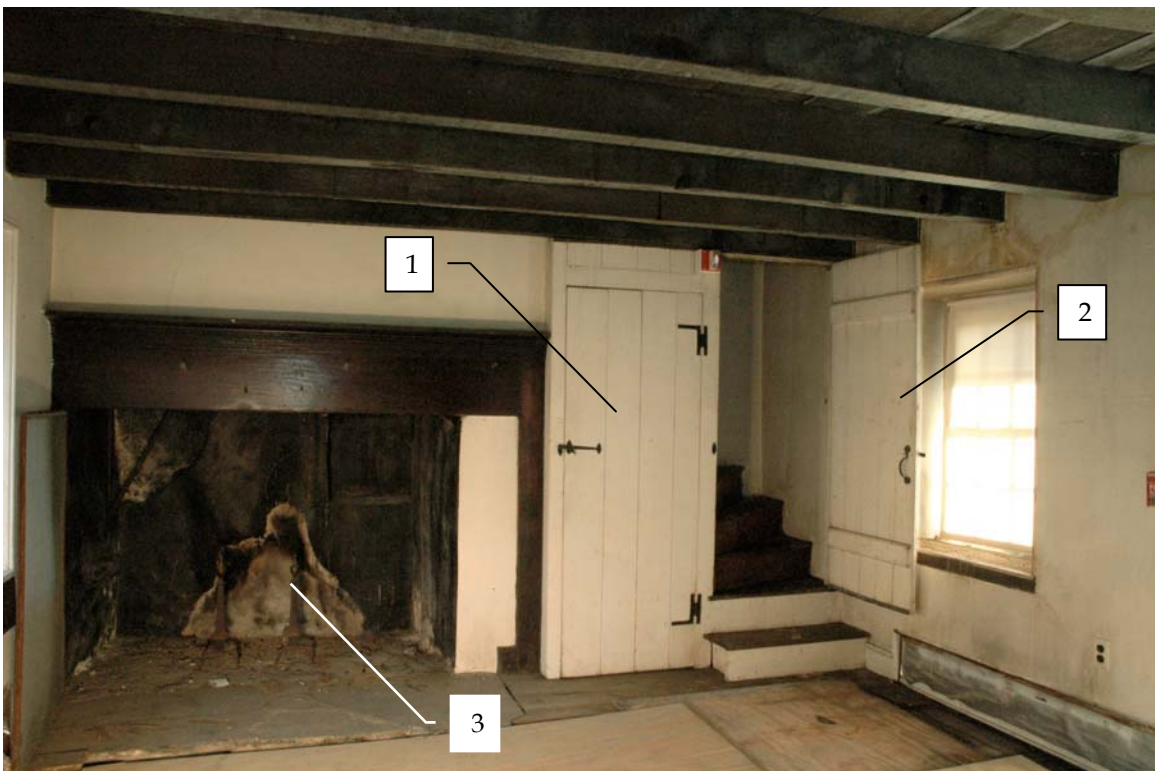
#### Fireplace

- The fireplace is an original c. 1830 cooking fireplace. It has been replastered, but the mantel appears to be original because the base layer of plaster abuts the mantelshelf and right leg.
- The hearth appears to have been raised, most likely when the second layer of flooring was added. The hearth pointing was installed against the edge of the flooring.
- There is evidence of an opening to a beehive bake oven, the existence of which has been confirmed by archeological investigations that revealed a stone foundation. (Note 4/101)
- The existing damper and cooking crane are not original.
- There is a stone "shelf" where a crane would have rested.



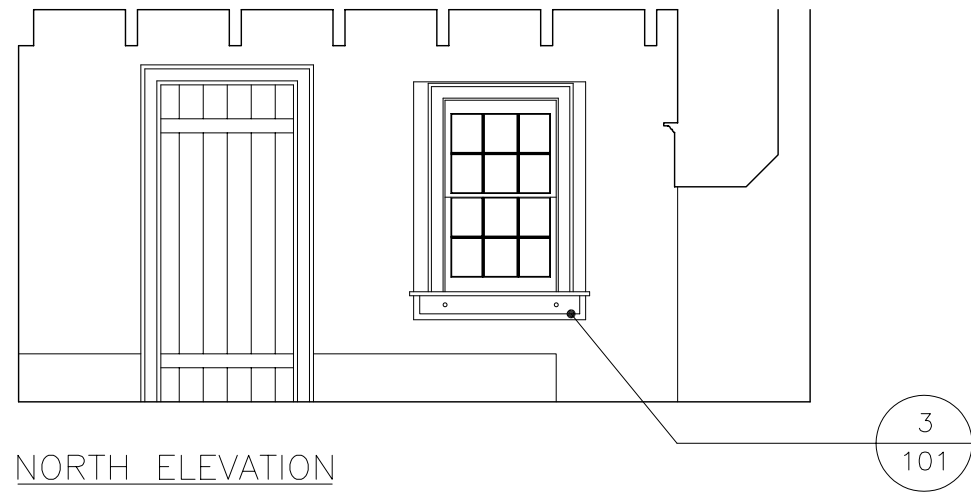
**Photo 101a** – Detail of plaster evidence below ceiling joist, south wall, Room 101, looking south.

1. Nail holes for lath at underside of joist.
2. Line of original c. 1830 plaster indicating intersection of wall and former ceiling plaster.

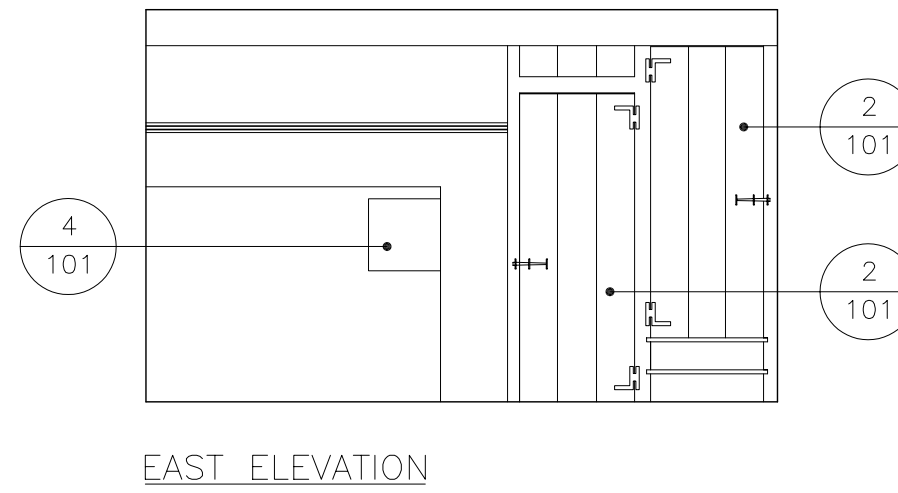


**Photo 101b** – Interior view of Room 101, looking east.

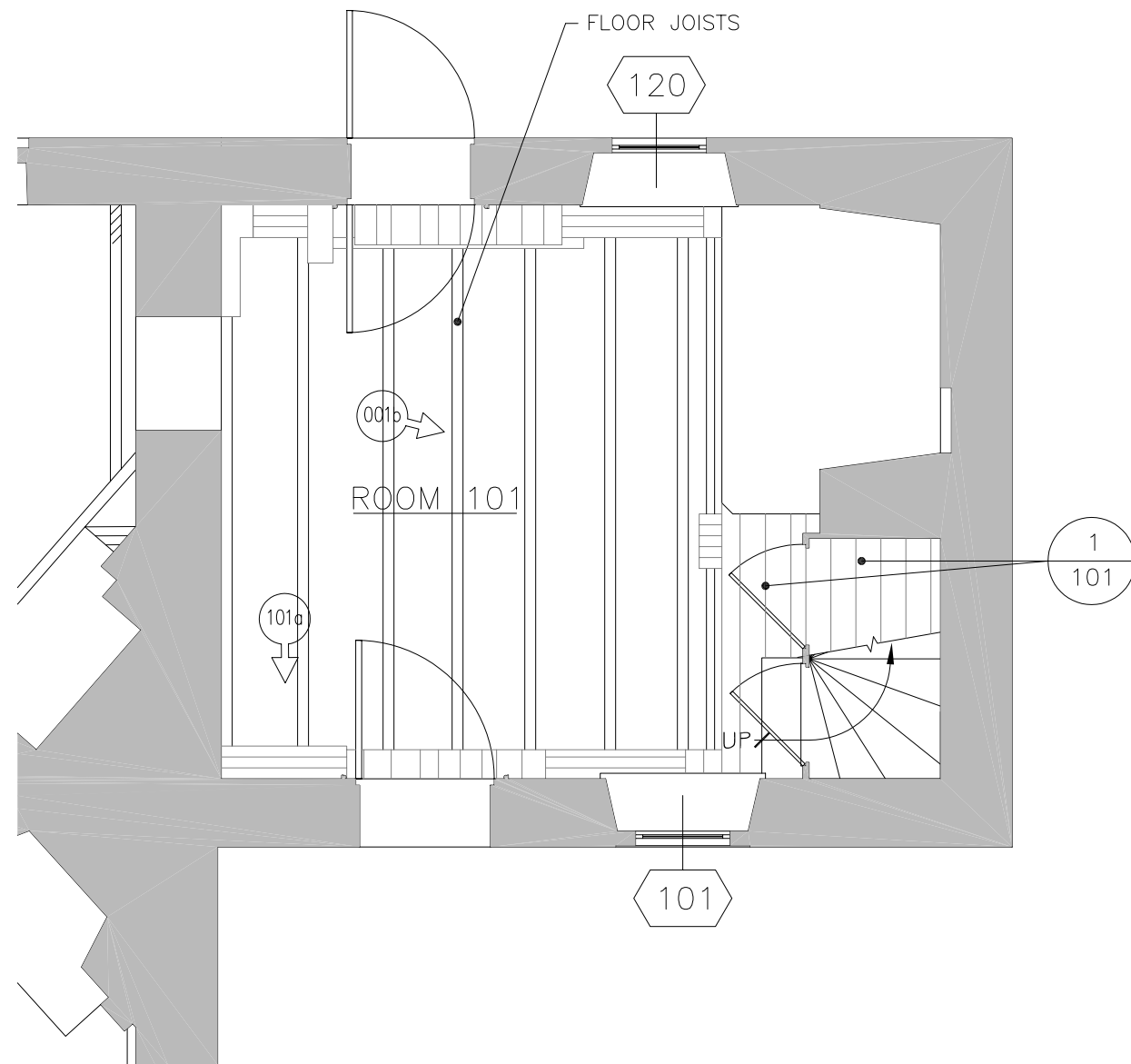
1. Original door to former winder stair to basement.
2. Original door to existing winder stair to 2<sup>nd</sup> floor.
3. Original cooking fireplace.



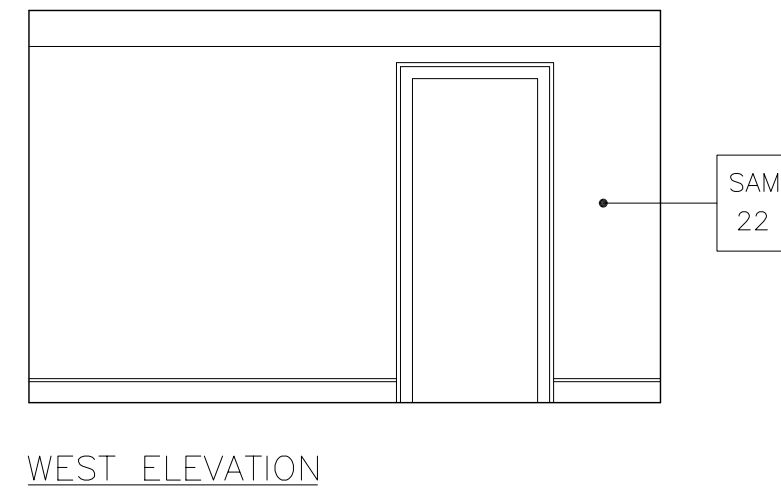
NORTH ELEVATION



EAST ELEVATION



SOUTH ELEVATION



WEST ELEVATION

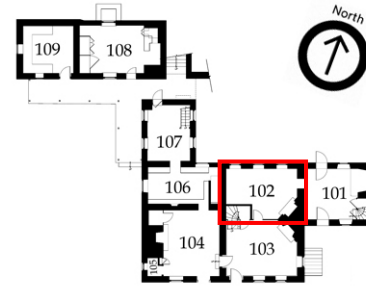
**LEGEND:**

N  
 NUMBER & DIRECTION OF PHOTO 000a  
 NOTE FROM DESCRIPTION NARRATIVE 1 000  
 MATERIAL SAMPLE LOCATION SAM 00

SCALE OF FEET

### Room 102 -

Room 102 is part of the main block of the original circa 1769 house. The room is likely that referred to by Thomas Walker in his 1835 will as the "Clock Room."



### Floor

- Flooring was originally random-width floor boards. A 1990s survey also noted another floor on top with fake pegs running parallel with the joists that is attributed to the Ligget family. Only fragments of the flooring remain. (Photo 102a)
- Existing floor joists are severely rotted at the bearing ends. (Note 1/102)

### Walls & Baseboards

- North, east and west walls have two layers of plaster on stone masonry walls.
- South wall is plaster on the beaded board stair surround. The south wall adjacent to the corner fireplace is comprised of vertical boards, hand-split lath and plaster. The plaster has been replaced and does not match the 1769 plaster found on the stone walls.
- Exploration of the west wall revealed no openings on this wall. (Photo 102a, Note 4/102)
- West wall has evidence of recent shelving. (Photo 102a, Note 5/102)
- Where not removed for baseboard radiators, the wood baseboards are not original. The profile is the same as Room 103 and Room 101 and the baseboards are applied on top of the new floor and the second layer of plaster. Furthermore, the height of the baseboard does not align with the baseboard line in the original plaster.

### Ceiling

- Ceiling joists are exposed. Joists have nail holes for lath boards. Ceiling was likely removed as part of the 1926 renovations.

### Doors

- East doorway was added at the time of the c. 1830 addition. (Photo 102b)
- South doorway appears to be original. The door is a six-panel door with hand planed panel profiles.

### Windows

- Three windows on the north wall are 6/6 single-hung, wood windows. Sash in all windows have been replaced.
- Windows 118 & 119: Investigation of the window jambs confirms that the center and east windows are original openings with the rounded plaster jambs intact below a more recent plaster layer. (Photo 102c, Note 2/102)
- Window 117: West window shows disturbance of the west jamb with broken stones and brick infill. The east jamb of this window does not show the same



disturbance. This indicates that the size of the opening was modified or that this was not an original opening at all. The 1926 renovation drawings do not show this window. (Note 3/102)

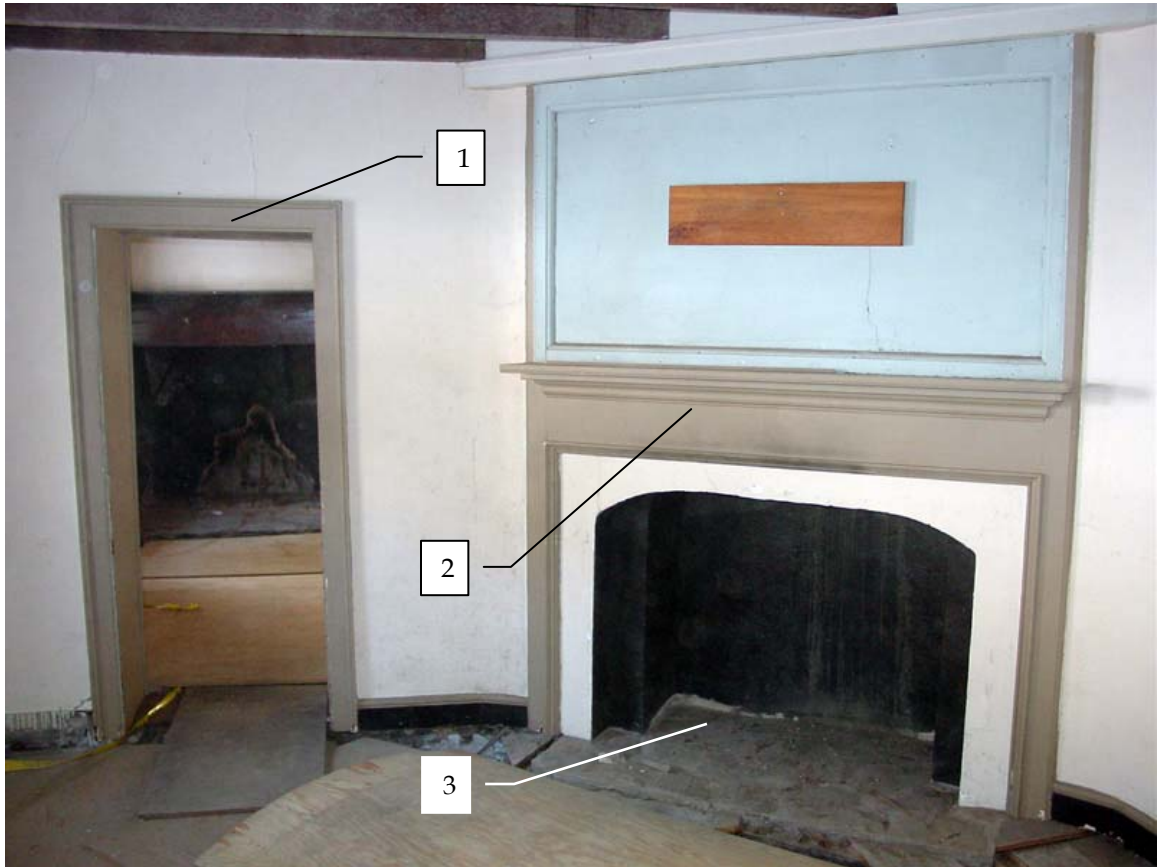
### Fireplace

- Corner fireplace is original. Basement foundation and framing confirm that it dates to 1769. (Photo 102b)
- Mantel is not original based on molding profiles and the wire nails used to secure the moldings. The original plaster runs behind the present mantel as well.



**Photo 102a** – View of west wall, Room 102.

1. Evidence in plaster finish of recent built-in shelving.
2. No evidence of former opening at west wall.
3. Wood flooring removed; wood joists severely rotted.



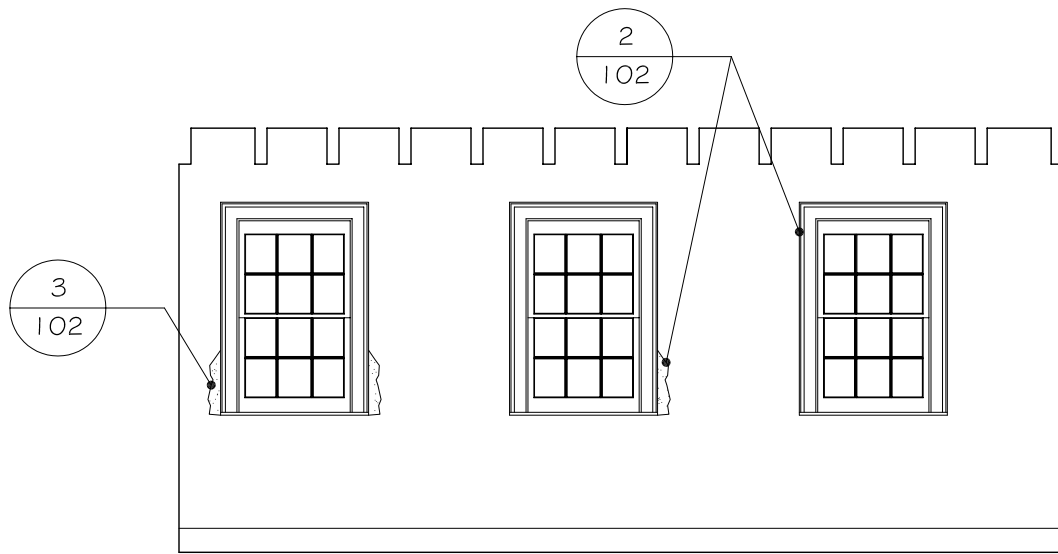
**Photo 102b** – View of east wall, Room 102.

1. Doorway to east addition added c. 1830.
2. Replacement mantel.
3. Original c. 1769 fireplace.

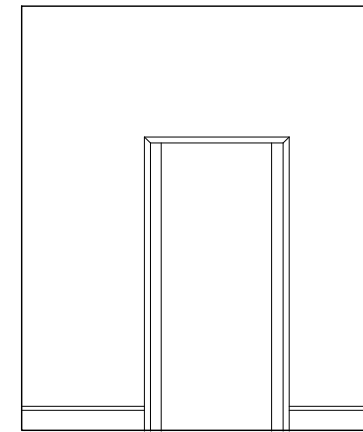


**Photo 102c** - Detail view of plaster at interior jamb, Window 118, looking northeast.

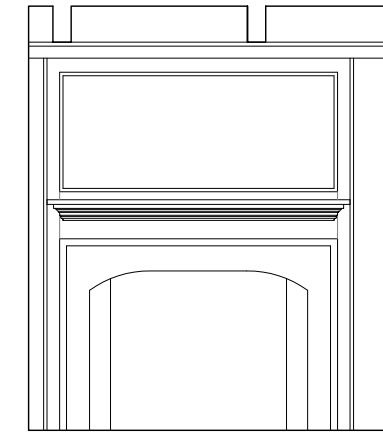
1. Original layer of plaster with curved jamb profile.
2. Cement-based, 20<sup>th</sup>-century plaster application.



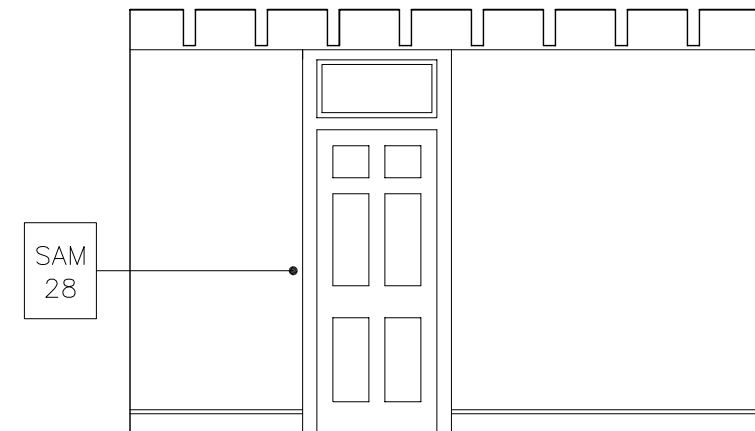
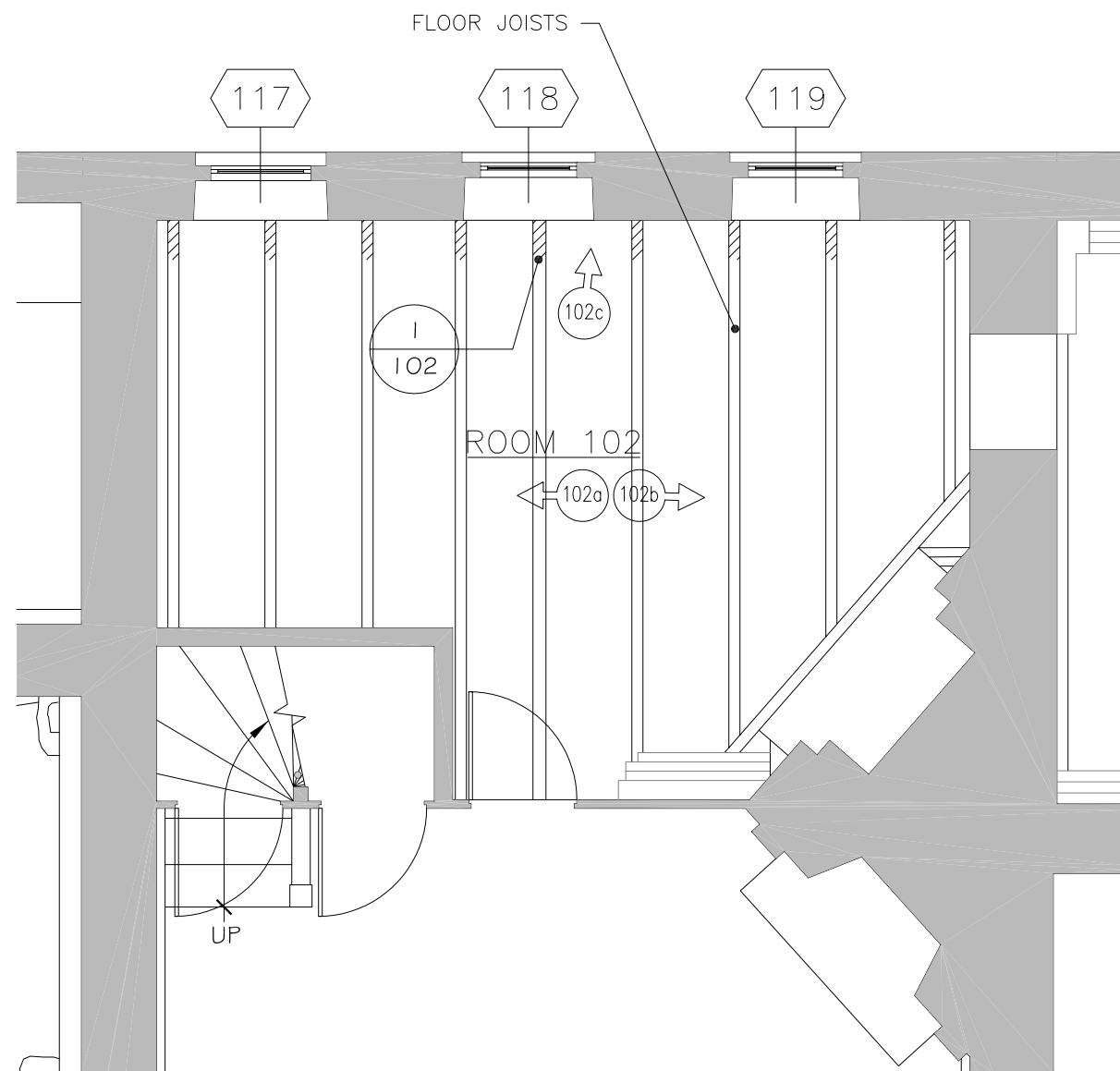
NORTH ELEVATION



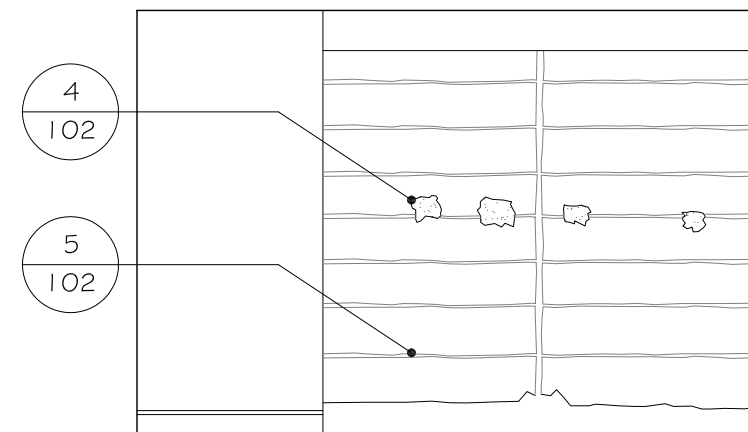
EAST ELEVATION



CORNER FIREPLACE ELEVATION





SOUTH ELEVATION





WEST ELEVATION


**LEGEND:**

NUMBER & DIRECTION OF PHOTO  000a

NOTE FROM DESCRIPTION NARRATIVE  1 000

MATERIAL SAMPLE LOCATION  SAM 00

 N

 SCALE OF FEET



### Room 103 -

Room 103 is the front room of the main block of the original circa 1769 house. A winder stair originally connected this room to the basement and the two floors above. This room is likely that referred to by Thomas Walker in his 1835 will as the "Parlour."



### Floor

- Flooring was originally random width floor boards. The present fake wood peg floor was added in 1926. (Photo 103a)

### Walls & Baseboards

- South, east and west walls have two layers of plaster on stone masonry walls.
- The north wall adjacent to the corner fireplace is comprised of vertical boards, hand-split lath and plaster. The plaster has been replaced and does not match the 1769 plaster found on the stone walls.
- Chair rail appears to be original to the 1769 construction period. The first plaster layer abuts the top and bottom of the chair rail. (Photo 103a)
- Investigations at the raised panel door jambs indicate that the detail is original at both doorways. There is no 1769 plaster behind the panels and the edge molding is applied with hand-wrought brads. (Photo 103b, Note 1/103)
- The 1769 plaster stops 1¼" below the ceiling joists and the top edge is slightly curved indicating that there was originally a plaster ceiling. (Note 2/103)
- Where not removed for baseboard radiators, the wood baseboards are not original. The profile is the same as Room 102 and Room 101 and the baseboards are applied on top of the new floor and the second layer of plaster. Furthermore, the height of the baseboard does not align with the baseboard line in the original plaster.

### Ceiling

- Ceiling joists are exposed. Joists do not have nail holes for lath boards, yet the wall evidence indicates that there was a ceiling in 1769. It is believed that the floor joists were replaced. This is further evidenced by the presence of the top plaster layer around the sides and bottoms of the joists. This work was most likely part of the 1926 renovations. (Photo 103c)

### Doors

- Removal of plaster at the east jamb of the main entry door (south wall) revealed a ½" gap between the plaster and the door frame. This suggests that the original 1769 door frame was deeper and has subsequently been replaced or repositioned. The existing door appears to be a 20<sup>th</sup>-century reproduction based on the hardware and reproduction rosehead nails in the door boards. It is possible that the interior door boards are replacements on the original exterior panels.
- All three of the north wall doors appear to be original. The panels are hand planed. The hardware, however, appears to be reproduction and there are filled holes from earlier hardware. (Photo 103a)

- The west door into the original kitchen wing also appears to be original and matches the profiles of the north doors.

#### Windows

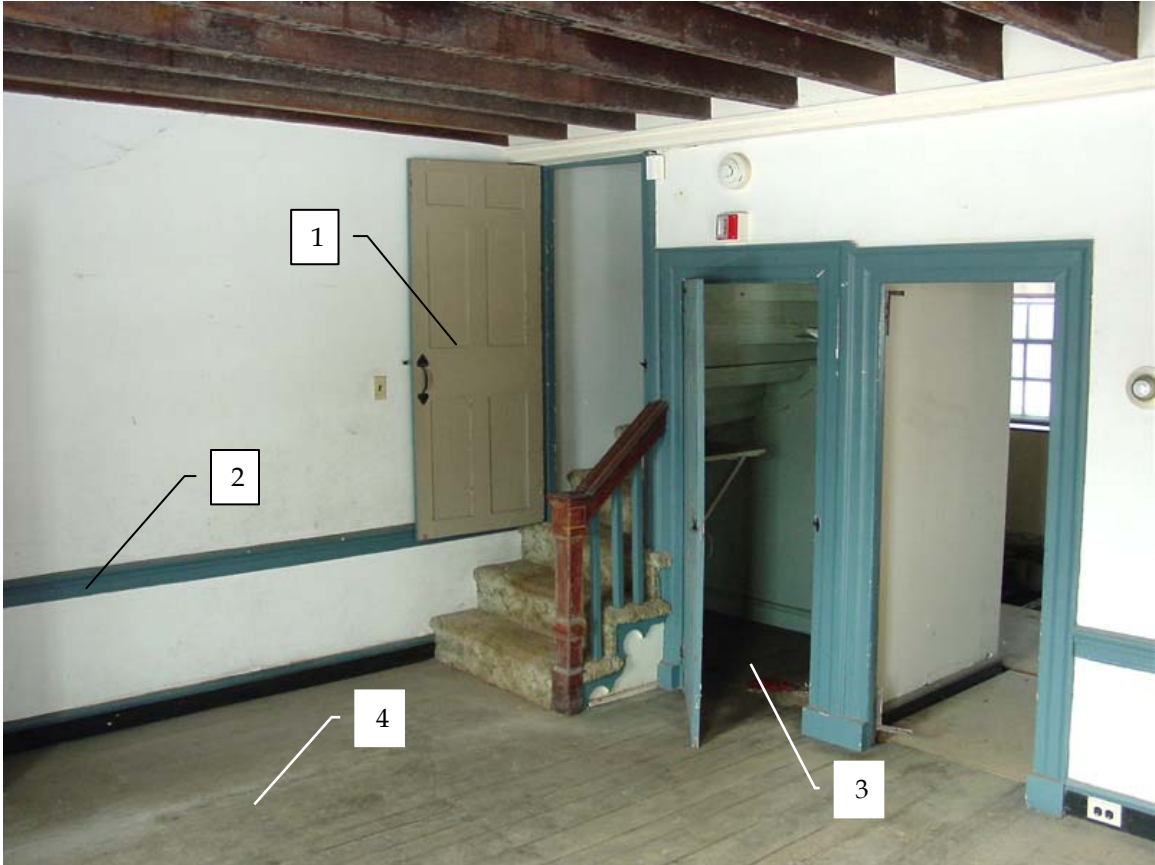
- Windows 103 & 104: Two windows on the south wall are 6/6 single-hung, wood windows. The detailing and profiles of the windows are consistent with 18<sup>th</sup>-century characteristics and are likely original.
- Window 102: Investigation at the east window exterior jamb revealed brick infill and indicates that this window opening is not original. Archive photographs show the east façade without the window which further corroborates that it is not original. The addition of this window is attributed to the Ligget family. There is also a seam in the chair rail cap and window sill where the sill for the new window would have been inserted. (Archive Photos 2 & 4)

#### Fireplace

- Corner fireplace is original. Basement foundation and framing confirm that it dates to 1769.
- Mantel is not original based on molding profiles and the wire nails used to secure the moldings. The original plaster runs behind the present mantel as well.
- Hearth stones may be original to 1769 but the pointing is not. The pointing was installed against the edge of the top layer of wood flooring.

#### Stair

- Winder stair treads are plastered into wall. Hand-wrought rosehead nails are visible in the treads and risers at one location where the carpet was lifted. (Note 3/103)
- Metal grab bar in stair has been added.
- There was a winder stair from the first floor to the basement in 1769. The floor framing shows a framed stair opening and the bottom layer of floor boards in the closet, when viewed from the basement, are different from the remainder of the room. (Note 4/103)



**Photo 103a** – Interior view of Room 103, looking northwest.

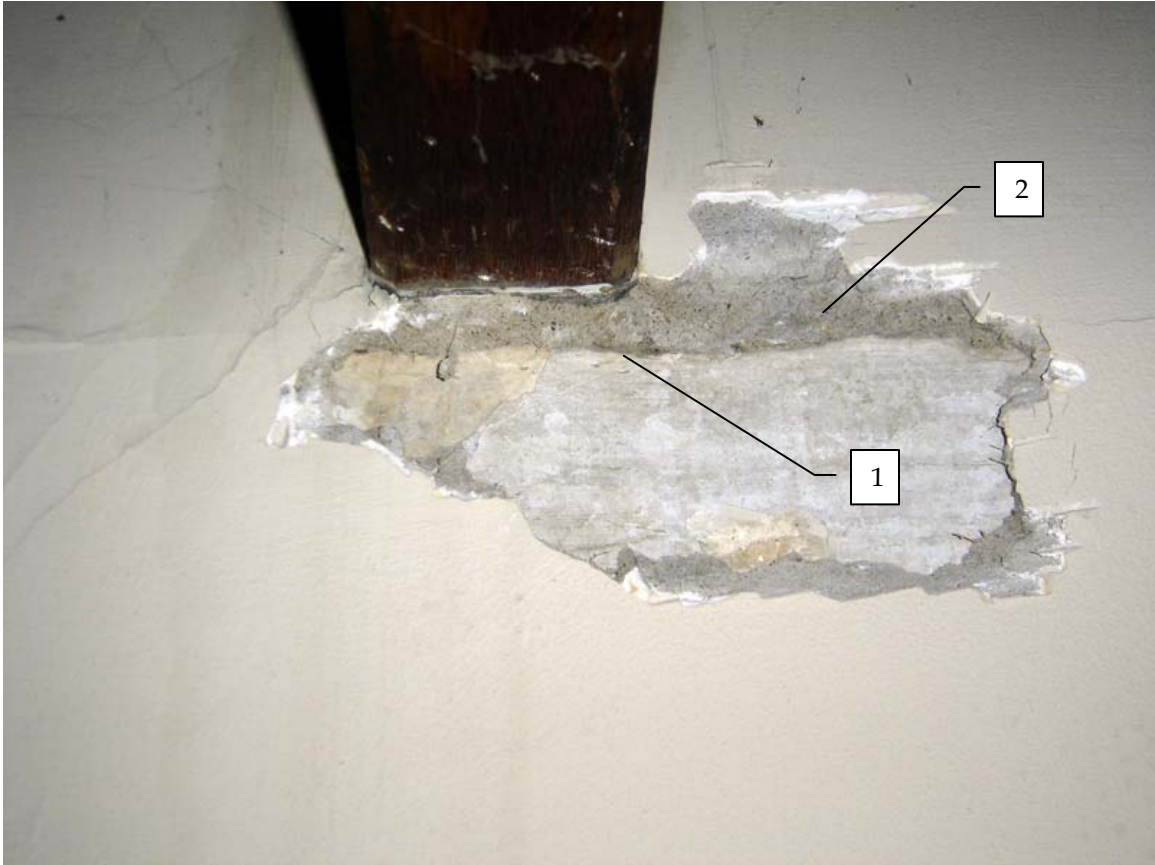
1. North wall doors appear to be original to c. 1769 main block.
2. Chair rails appear to be original to c. 1769 main block.
3. Winder stair to basement removed in 1926.
4. Replacement faux-pegged wood flooring.



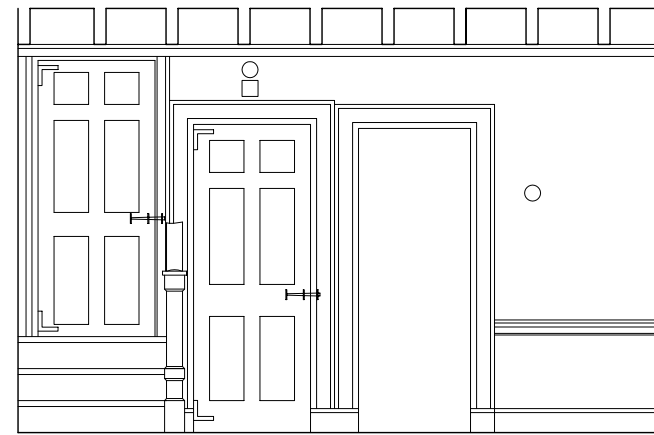
**Photo 103b** – Oblique view of paneled jambs at south door (left) and west door to original c. 1769 kitchen (right), looking south.

1. Original first-layer plaster turns corner above chair rail.
2. Original first-layer plaster abuts original wood framing for raised panel jamb below chair rail.

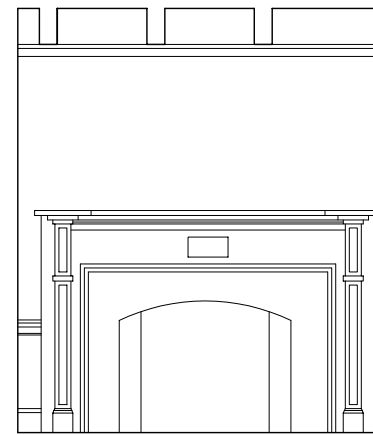




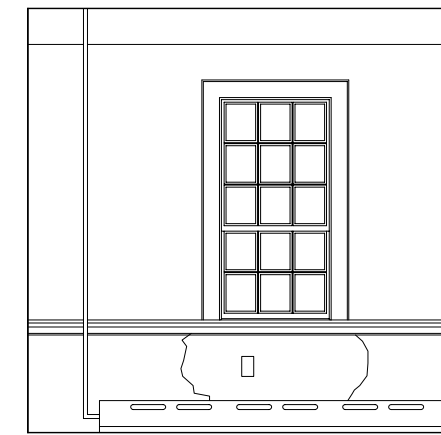
**Photo 103c** - Detail of plaster evidence below ceiling joist, south wall, Room 103, looking south.  
1. Line of original c. 1769 plaster indicating intersection of wall and former ceiling plaster.  
2. Early 20<sup>th</sup>-century cement-based plaster infill.



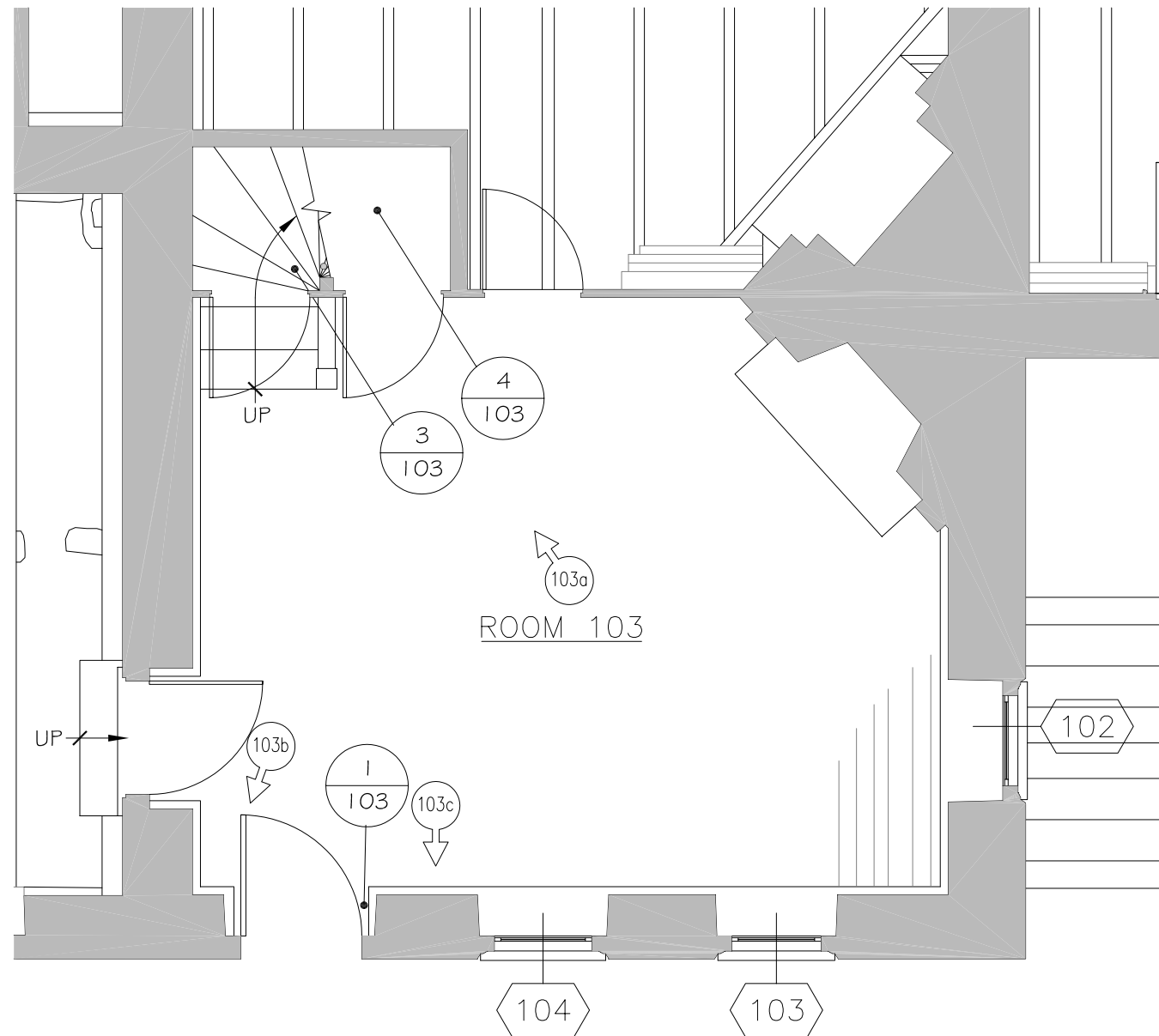
NORTH ELEVATION



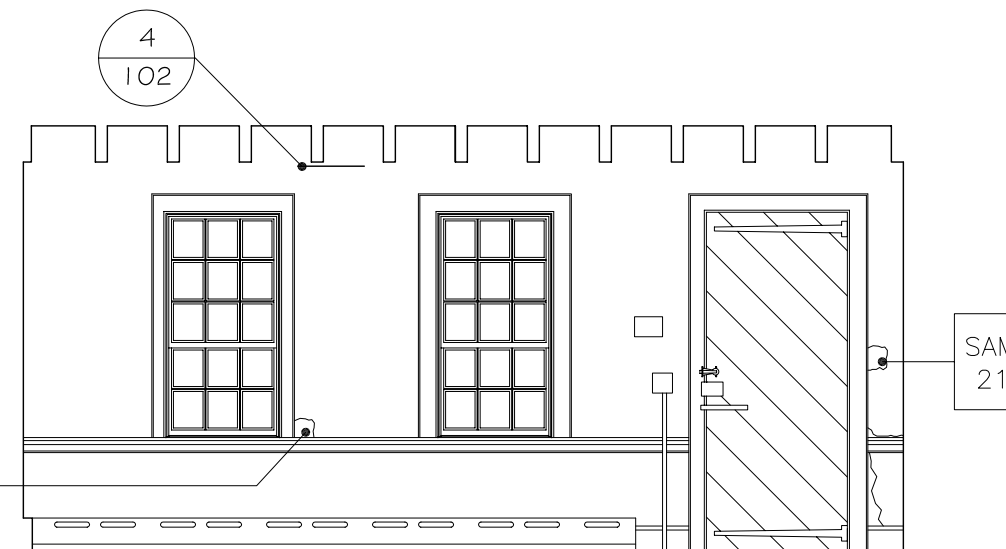
CORNER FIREPLACE ELEVATION



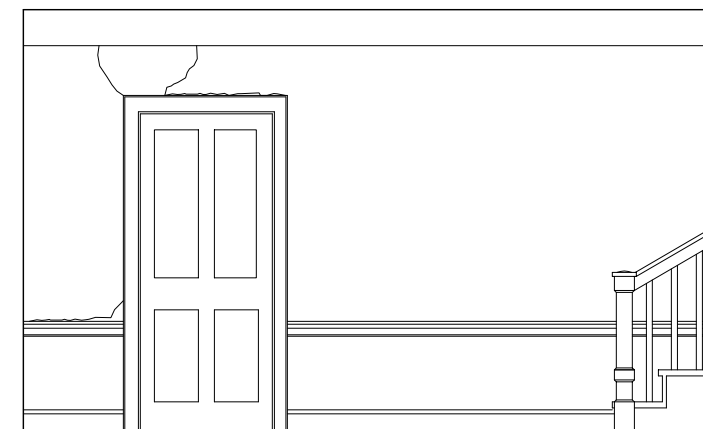
EAST ELEVATION



ROOM 103







SOUTH ELEVATION




WEST ELEVATION

**LEGEND:**

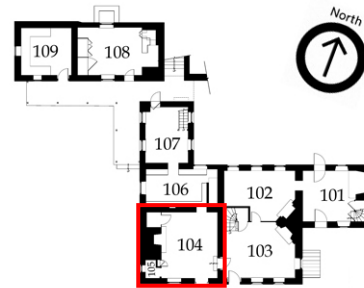
- NUMBER & DIRECTION OF PHOTO  000a
- NOTE FROM DESCRIPTION NARRATIVE  1 000
- MATERIAL SAMPLE LOCATION  SAM 00

 N

 2 0 2 4  
SCALE OF FEET

### Room 104 -

Room 104 is the original kitchen wing of the 1769 house. The room underwent significant renovations in 1926 including the infill of the large 18<sup>th</sup>-century cooking fireplace and removal of the 19<sup>th</sup>-century winder stair.



### Floor

- Remnants of original random-width floor boards exist near the south exterior door. Earlier investigations by graduate students from the University of Pennsylvania indicated that there was a top layer of 20<sup>th</sup>-century, fake pegged flooring which matched the flooring in the main block.
- All other flooring has been removed.
- Joists are a mixture of sizes and several appear to have been salvaged from earlier structures since there are unused framing holes and mortises. (Photo 104a)
- Joists are significantly deteriorated due to insects and the lack of ventilation in the crawl space.

### Walls

- Walls feature two layers of plaster on stone masonry.
- Plaster on wood lath at north wall covers an earlier window opening. A plaster on wire lath patch covers previous architectural investigations. (Photo 104a, Note 1/104)

### Ceiling

- A plaster “ceiling” has been installed between the exposed floor joists. It is attached to 20<sup>th</sup>-century sawn nailers which are applied with wire nails. (Photo 104b)
- Exposed ceiling joists have beaded edges and plaster lath marks. It is believed that the ceiling was originally exposed because there is early wall plaster running up between the joists. Sometime around 1810-1830 when major renovations occurred, a plaster ceiling was installed and then removed by the Liggett family in the 20<sup>th</sup> century. (Note 3/104)
- One of the ceiling joists is rotted. (Note 2/104)

### Doors

- South door is a Dutch door with a nine-light glass panel in the upper leaf. Door appears to be a 20<sup>th</sup>-century reproduction made with reproduction rosehead nails. Door frame appears original. (Photo 104c)
- The north doorway has been modified at least once when the vertical wood jamb and door trim were added. Beneath these boards a finished plaster jamb is visible. The west stone jamb of this doorway has been modified for the introduction of Romex electrical wiring.
- East doorway is raised up two stair risers to access Room 103. The jamb of the doorway may have been modified since there is a gap in the south side between

the door frame and the stone masonry opening. This gap is covered with short pieces of split lath with a newer, non-1769 plaster on top. (Note 7/104)

### Windows

- Window 105: 8/8 single-hung wood window. The interior molding and general detailing of the surround are very similar to the windows in the east addition. The lower sash appears to be a 20<sup>th</sup>-century replacement sash. The upper sash appears to be c. 1830. The original 1769 window opening may have been modified c. 1810 to increase light in this room at the time when the north kitchen addition was blocking the north window and door. However, the earliest plaster layer abuts both sides of the existing window trim. This either means that the window frame dates to 1769 or that the room was entirely re-plastered. (Note 8/104)
- Plaster removal on the north wall revealed an early window frame. The frame appears to be original to the kitchen (c. 1769), and shows signs of weathering on what was the exterior sill. (Photo 104a)

### Fireplace

- The current fireplace mantel profiles and assembly with machine cut brads indicate that it dates to the 20<sup>th</sup> century. The 1979 "Inventory," in fact, states that it was the Ligget family who modified the fireplace. (Photo 104a)
- The closet to the north of the existing fireplace reveals numerous features indicating that the original 1769 fireplace was a large cooking fireplace:
  - Large wood lintel is still in place. (Note 5/104)
  - Disturbance on west wall is probably a bake oven opening that has been infilled. Archeology undertaken by VFNHP confirms the existence of an exterior bake oven.
  - A built-in lugpole and mantel tree can be seen in the cupboard. (Note 5/104)
  - Part of a larger chimney stack can be seen rising inside the closet. (Note 6/104)
- The current hearth has also been modified. Current hearth has been built out from the fireplace wall and aligns in width with the present, smaller firebox. Below this hearth is a hearth foundation extending to the north wall and projecting out only 12" from the fireplace wall. There is another joint between this hearth foundation and the fireplace foundation wall on the west side. (Photos 104a & 104d, Note 4/104)
- There is no evidence or shadow line of a mantelshelf on the north wall.

### Millwork

- China cabinet was added by the Ligget Family in 1926. It is shown on their renovation drawings (see Appendix E).





**Photo 104a** – Interior view of Room 104, looking northwest.

1. Original cooking fireplace modified to current configuration as part of 1926 renovations. Mantel and cupboard added at that time.
2. Investigation at north wall revealed masonry opening for original kitchen window.
3. Wood flooring removed; joists appear to have been salvaged from earlier structures as evidenced by unused mortises and other cuts.
4. Original hearth has been modified to accommodate reconfigured fireplace.



**Photo 104b** – View of ceiling, Room 104, looking northeast.

1. Original beaded wood joists.
2. Plaster ceiling installed between joists.



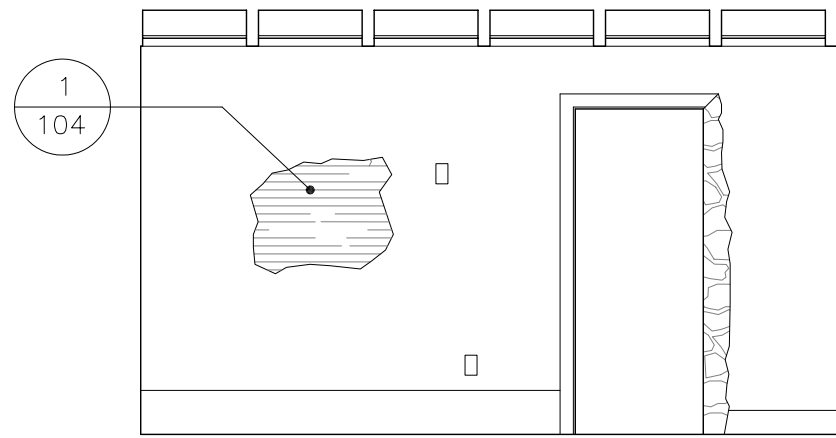
**Photo 104c** – Interior view of Room 104, looking southeast.

1. Replacement Dutch door set in original c. 1769 wood frame.

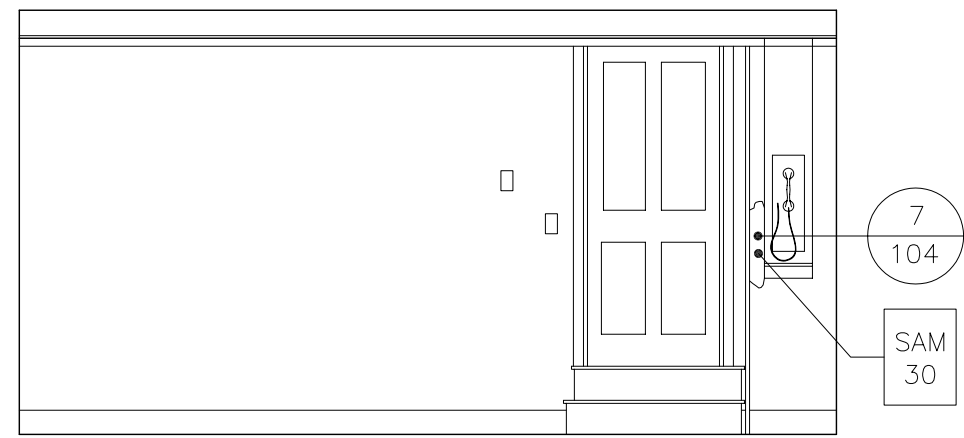


**Photo 104d** – Detail view of south end of hearth foundation, Room 104, looking northwest.

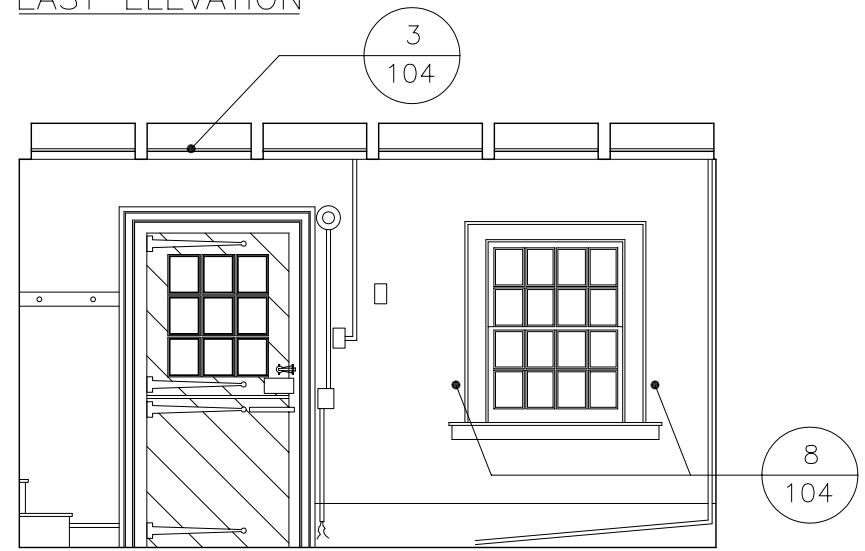
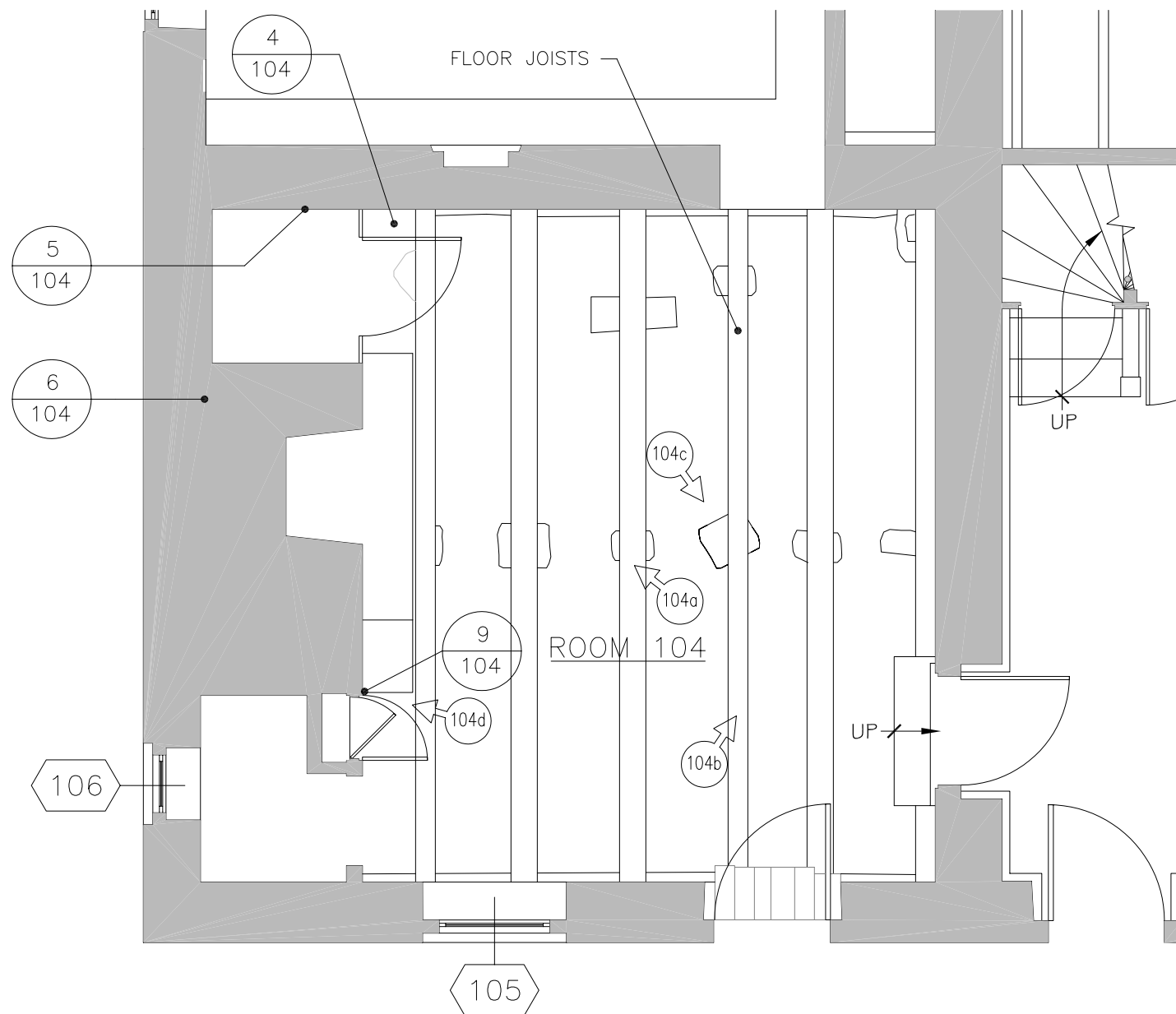
1. Joint between original hearth foundation and subsequent "build-out" to accommodate modifications to original cooking fireplace and the expanded hearth.



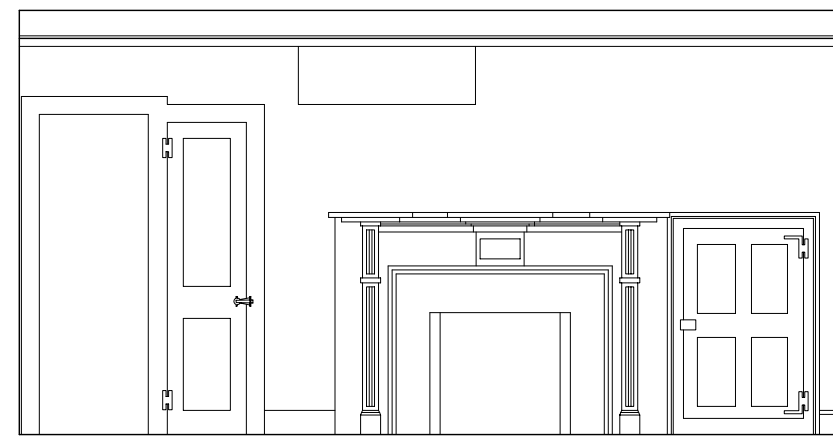
NORTH ELEVATION



EAST ELEVATION





SOUTH ELEVATION





WEST ELEVATION


**LEGEND:**

NUMBER & DIRECTION OF PHOTO  000a

NOTE FROM DESCRIPTION NARRATIVE  1 000

MATERIAL SAMPLE LOCATION  SAM 00

 N

 2 0 2 4

SCALE OF FEET



### Room 105 -

Room 105 is located in the southwest corner of the original kitchen block. A winder stair to the upper floor was removed from this location and a powder room was installed in its place as part of the 1926 renovation work.



### Floor

- Tile floor installed c. 1926.

### Walls

- Tile wainscot installed c. 1926.
- North wall, against chimney, has been furred out with 20<sup>th</sup>-century studs and drywall to form a plumbing chase. (Photo 105a)
- Traces of winder stair treads to second floor are evident behind 20<sup>th</sup>-century north wall and in earlier plaster layer. (Photo 105a, Note 1/105)
- East wall, door, and cabinet added c. 1926.

### Ceiling

- Ceiling is drywall; and it stops at the face of the new north stud wall indicating that it was installed at the same time.

### Door

- Door is missing.

### Window

- Window 106: six-light casement installed c. 1926.

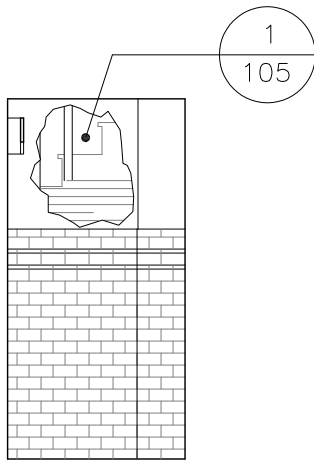
### Stair

- Winder stair was probably removed c. 1926 at the time of the bathroom installation.

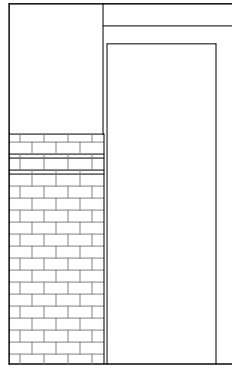


**Photo 105a** - Detail view of north wall, Room 105, looking north.

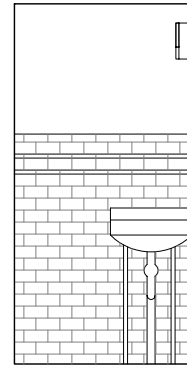
1. Original cooking fireplace cheek wall.
2. 20<sup>th</sup>-century stud wall furring with lath and plaster.
3. Evidence of winder stair in early plaster.



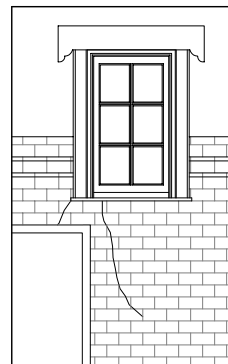
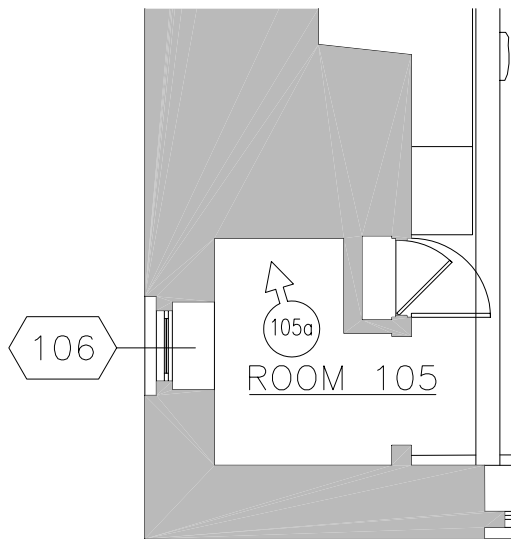
NORTH ELEVATION



EAST ELEVATION








SOUTH ELEVATION



WEST ELEVATION

LEGEND:

NUMBER & DIRECTION OF PHOTO   
 NOTE FROM DESCRIPTION NARRATIVE   
 MATERIAL SAMPLE LOCATION 

SCALE OF FEET

Historic Structure Report  
**STIRLING'S QUARTERS**  
 Valley Forge National Historical Park

**JOHN MILNER ARCHITECTS, inc.**

104 Lakeview Drive, Chadds Ford, Pennsylvania 19317 • (610) 388-0111

**PHYSICAL  
 DESCRIPTION**

**ROOM 105**

### Room 106 -

This room was likely added as part of the expansion of the original kitchen block circa 1810. A second cooking fireplace with bake oven was located along the west wall. This room was completely remodeled in 1926 to accommodate a modern kitchen.



### Floor

- The floor joists and floor boards were heavily damaged by termite infestation and were removed by VFNHP.
- At the south and north walls, there is a stone shelf that extends approximately 12" inside of the foundation wall. The removed floor joists were supported on this shelf. However, the construction, particularly along the north wall, seems to suggest that this stone shelf may have been in place prior to the c. 1810 addition. One possibility is that the low stone wall was the foundation for a porch on the north side. (Photo 106c, Note 8/106)
- At the east side of the room is a stairwell formed by stone walls installed as part of the c. 1926 renovation work. There is also a stone ledge similar to the north and south walls. It is unclear if this "ledge" ties into the south stone ledge. (Photo 106c)

### Walls & Baseboards

- All walls are plastered directly onto stone masonry. There are areas of one layer of plaster and other areas that have a second layer of plaster.
- There are remains of a previous 20<sup>th</sup>-century wood stud partition at the east wall which enclosed a basement stair. (Note 2/106)
- The west side of the north wall shows charring on the stone beneath the plaster. This is thought to be from the original c. 1810 cooking fireplace. (Photo 106a, Note 1/106)
- A large section of the south masonry wall has been removed to accommodate pipes for the heating and/or plumbing systems. (Note 3/106)

### Ceiling

- Plaster removal at the ceiling and top of south wall revealed that the ceiling joists were originally exposed when first installed in c. 1810 because the wall plaster continues up and around the joists.

### Doors

- The south doorway has been modified at least once when the vertical wood jamb and door trim were added. Beneath these boards a finished plaster jamb is visible. The west stone jamb of this doorway has been modified for the introduction of Romex electrical wiring. The wood door sill is severely damaged by termites. (Note 4/106)
- Although it would have been very close to the cooking fireplace, the north door masonry opening may have been the original door opening in c. 1810. There is no physical evidence around the window suggesting that the window was once a



door, nor is it likely that this room would not have had a door to the exterior. (Note 5/106)

#### Fireplace

- Previous investigations and plaster removal have exposed a lintel pocket for a large cooking fireplace. The iron eye anchor and plaster staining from the kettle swing crane are still present. The floor and hearth have been removed, but there are multiple stones below where the floor height would have been. These may have at one point been part of the hearth and/or chimney stack. The presence of the chimney related to this fireplace is clearly evident in historical photographs. The chimney and fireplace were removed by the Ligget family in 1926 so that they could install a "modern" kitchen. (Photo 106a)
- There is a small recess in the west wall which supports the archeological investigations that indicate the presence of a bake oven on the west side of the building in this location. In addition, bricks used to infill the bake oven opening are visible on the interior and exterior of the building. (Note 10/106)

#### Windows

- Window 107: 6/6 double-hung wood window. This window opening was installed by the Ligget family when the fireplace and chimney were removed.
- Window 116: 8/8 double-hung wood window. The sill of this window has been removed due to termite damage. General detailing of this window suggests that it may date to the original c. 1810 construction of this room. (Note 6/106)

#### Millwork

- There is a built-in cabinet on the south wall. Upon closer inspection, the cabinet is inserted into an original c. 1769 window frame. The weathering on the sill confirms that it was at one point open to the weather to the north, and this partition was once an exterior wall (i.e., the north wall of the c. 1769 kitchen wing). The dimensions correspond to a 4-light over 4-light single-hung window. (Note 7/106)

#### Stairs

- The east end of the room was heavily modified in 1926 by the addition of an interior basement stair. The wood stair has been removed due to deterioration, but the stone retaining wall forming the stair areaway is intact and in good condition. (Photo 106c, Note 9/106)



**Photo 106a** - Detail view of northwest corner of Room 106, looking north.

1. Charring at stone masonry thought to be from c. 1810 cooking fireplace.
2. Pocket in stone masonry where end of former fireplace lintel was located.



**Photo 106b** - Built-in cabinet set in original window frame at south wall of Room 106, looking southwest.

1. Weathered wood sill was originally exposed to the elements.
2. First-layer of plaster applied to stone masonry butts against wood trim.
3. Pointing mortar at masonry beneath plaster is typical of the type found at other locations on the main block and original c. 1769 kitchen block.

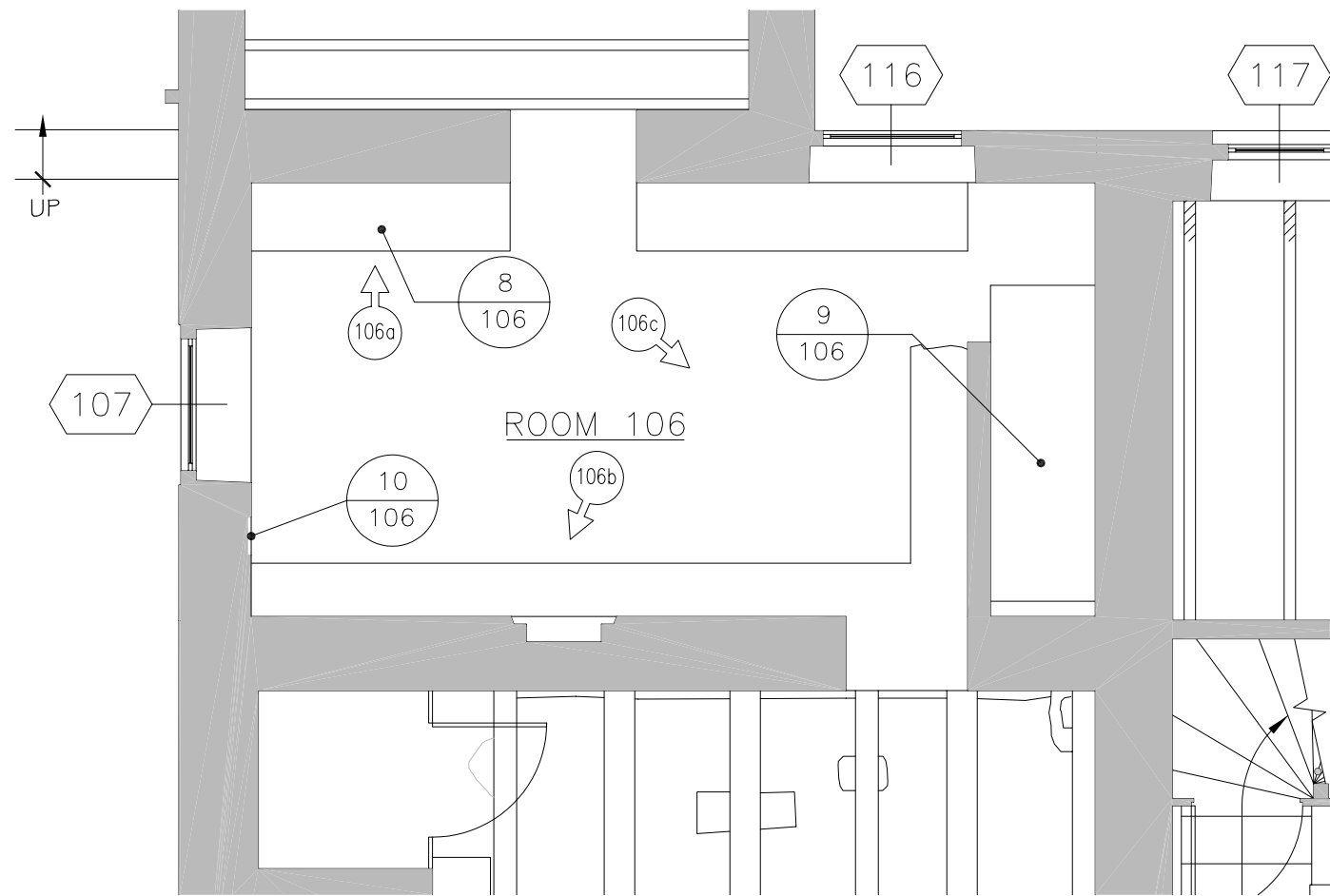
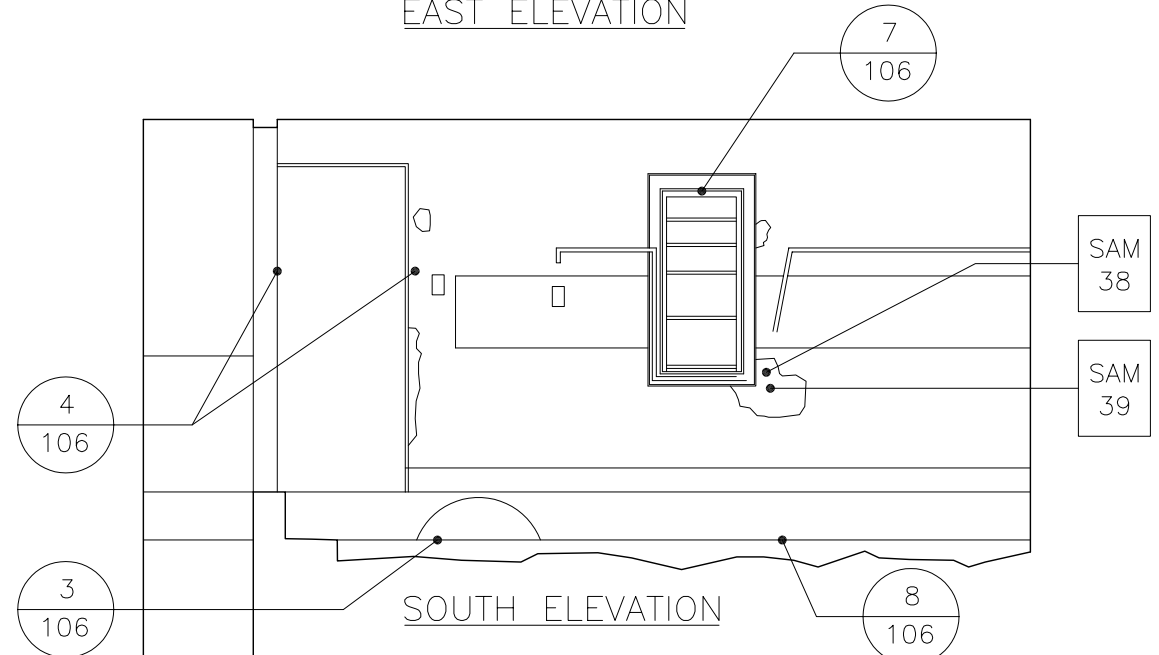
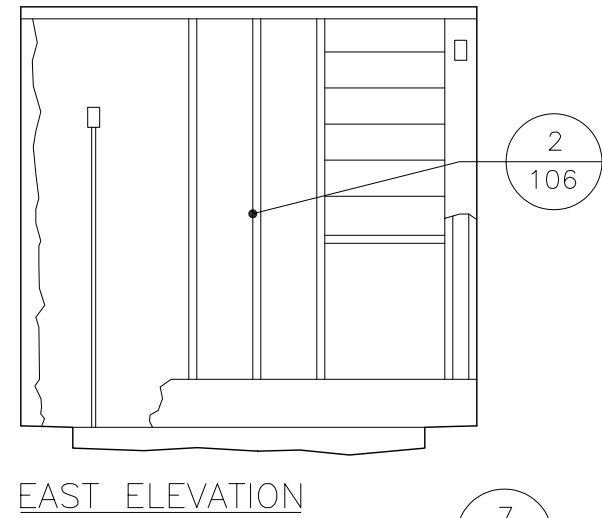
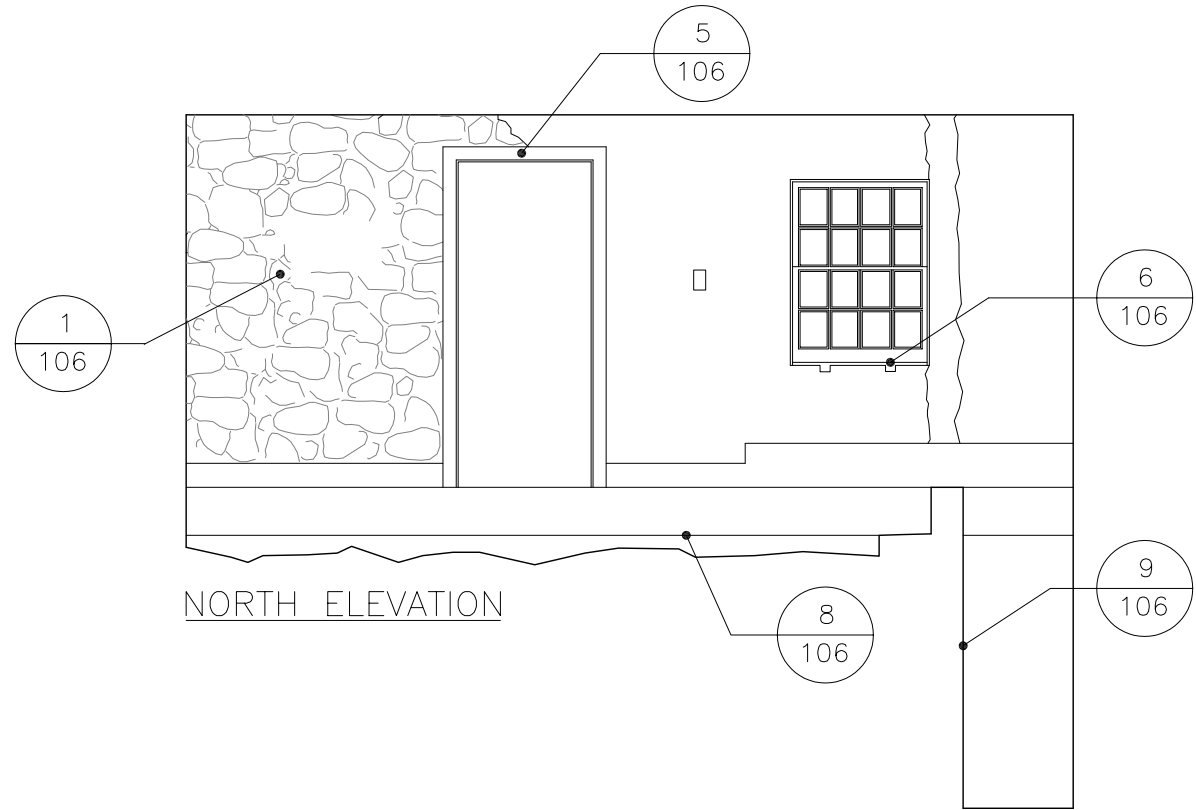





**Photo 106c** - General view of floor in Room 106, looking southeast.


1. New stair (missing) to basement introduced c. 1926.
2. Stone retaining wall for areaway.
3. Stone shelf.








**LEGEND:**

NUMBER & DIRECTION OF PHOTO  000a

NOTE FROM DESCRIPTION NARRATIVE  1 000

MATERIAL SAMPLE LOCATION  SAM 00

 N

 SCALE OF FEET

Copyright 2005 John Milner Architects, Inc.

Historic Structure Report  
**STIRLING'S QUARTERS**  
 Valley Forge National Historical Park  
**JOHN MILNER ARCHITECTS, inc.**  
 104 Lakeview Drive, Chadds Ford, Pennsylvania 19317 • (610) 388-0111

PHYSICAL DESCRIPTION

ROOM 106

### Room 107 -

Room 107 was added to the house as part of the 1926 renovations. At one time it was used as a scullery and laundry room.



### Floor

- The wood floor boards have been removed due to deterioration and to provide access into the unventilated and very shallow crawl space. At present there are loose sheets of plywood which provide a walking surface.

### Walls

- The walls are cement-based plaster on masonry.
- Traces of earlier stucco are visible beneath the plaster on the south wall.

### Ceiling

- The ceiling is plaster on sawn wood lath.

### Doors

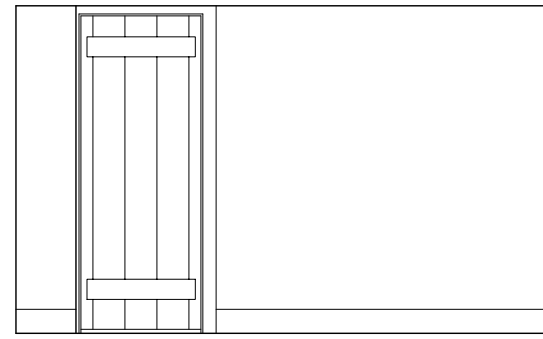
- The only remaining door is the north exterior door which is believed to be the original 1926 door.
- The masonry opening and doorway on the south wall appears to be an original c. 1810 opening. The jamb evidence has been disturbed by subsequent renovations. (Note 3/107)

### Windows

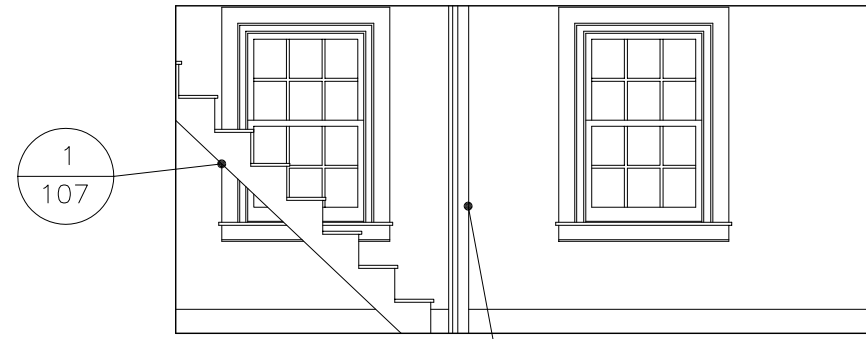
- Typical windows are 6/6 double-hung wood units installed c. 1926.

### Stairs

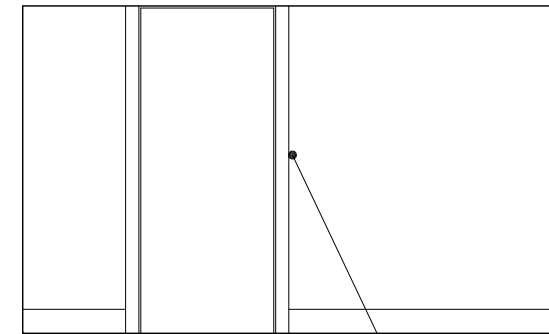
- The existing stair is a narrow, steep straight run stair up to the second floor. (Note 1/107)
- The railing is partially missing.
- The stair was originally enclosed because there is part of a door jamb remaining at the bottom. (Note 2/107)



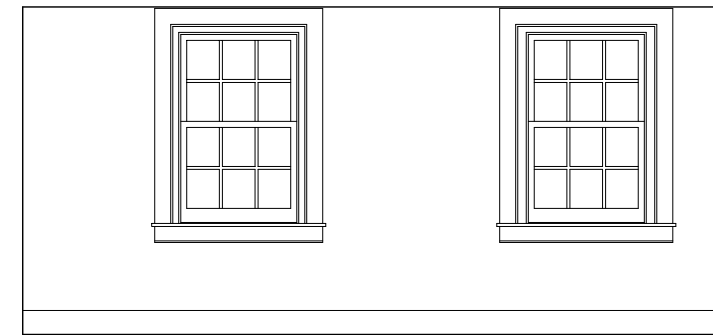
NORTH ELEVATION



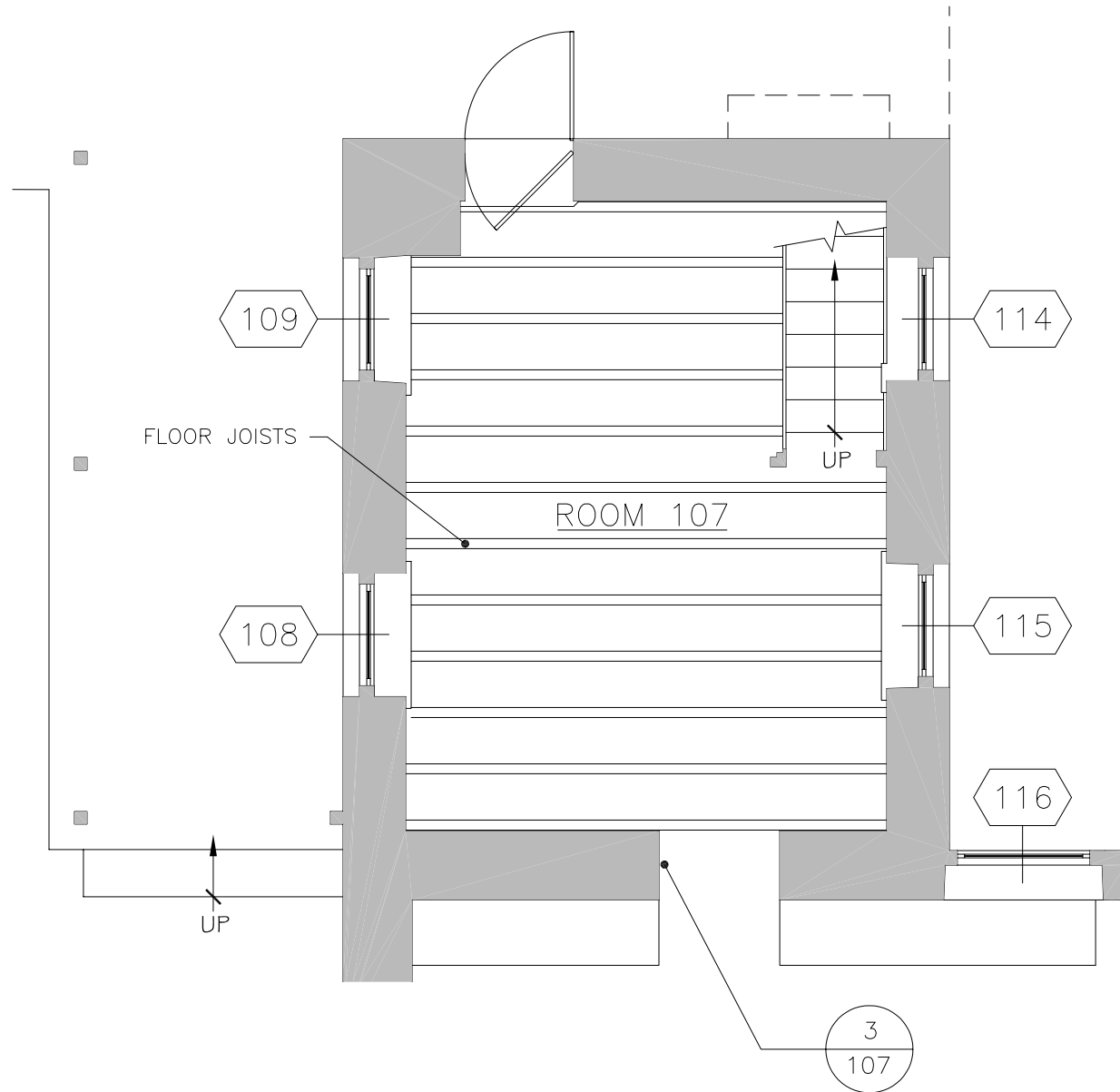
EAST ELEVATION




SOUTH ELEVATION





WEST ELEVATION





**LEGEND:**

NUMBER & DIRECTION OF PHOTO  000a

NOTE FROM DESCRIPTION NARRATIVE  1 000

MATERIAL SAMPLE LOCATION  SAM 00

 N

 2 0 2 4  
SCALE OF FEET

### Room 108 -

Room 108 represents the one-story bakehouse which was built adjacent to the springhouse sometime during the early 19th century.



### Floor

- Uneven brick floor. Although the bricks appear hand-molded, it is believed that the Ligget family installed the floor in 1926 as part of the extensive renovations to this room.

### Walls

- Plaster on masonry.

### Windows

- Window 110: 6/6 wood double-hung window installed in 1926. This window does not appear in archive photographs and may have been installed in an earlier door opening. (Note 1/108)
- Window 113: 6/6 double-hung window installed in 1926. This window matches the south window in detailing.

### Doors

- The south entrance door appears to be a new masonry opening. The door and frame appear to be 20<sup>th</sup>-century. Archive photographs from c. 1925 do not show a door in this location. Instead, a door is located more in the center of this south wall. (Note 2/108) (Archive Photos 6 & 7)

### Fireplace

- The east wall consists of a moderate sized fireplace with a bake oven in the northeast corner. The fireplace has been modified at least two times. Based on the size of the chimney visible in archive photographs and the interior smoke chamber, the original fireplace was probably one large fireplace that spanned the entire width of the room. Such a large fireplace may have been used as a summer kitchen but could also have been used for laundry, candle-making, etc. (Photo 108a)
- The fireplace was reduced in width and a bake oven was added sometime before 1925. There are visible joints in the smoke chamber where the flue was modified.
- In 1926, the size of the fireplace opening was further reduced by the addition of a wing wall in the front and the top of the bake oven was broken by the new steps from the second floor. (Note 3/108)

### Millwork

- Built-in cabinets/closets along west wall were installed by the Ligget family in 1926. The doors are fabricated with reproduction nails. (Photo 108b, Note 4/108)

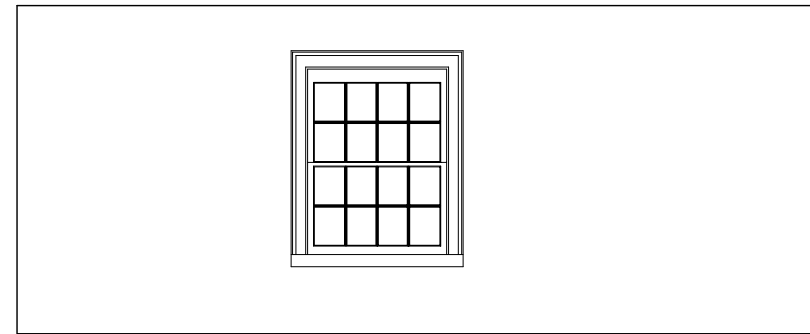




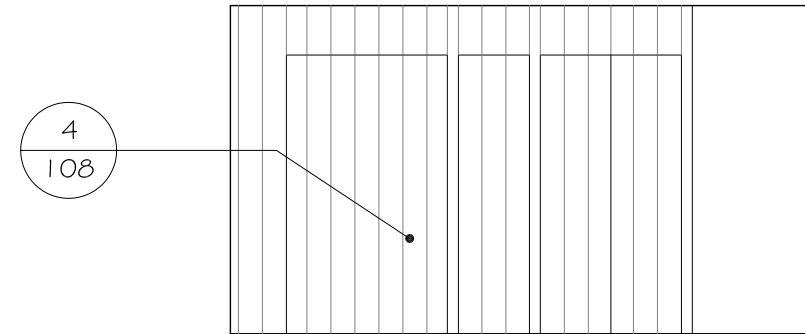
**Photo 108a** - Segment of east wall of bakehouse, Room 108, looking east. Fireplace has been modified substantially from its original configuration.



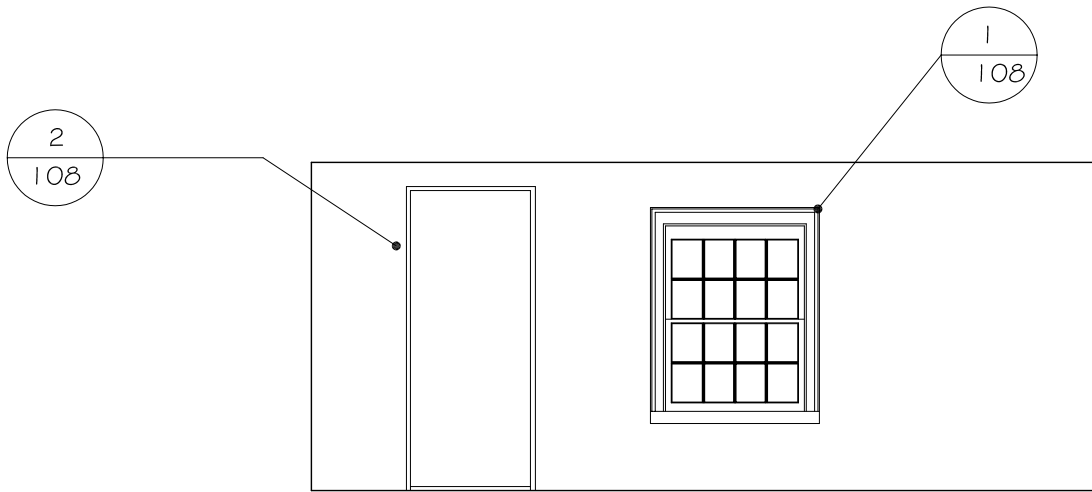
**Photo 108b** - 20<sup>th</sup>-century cabinetry at west wall of bakehouse, Room 108, looking west.



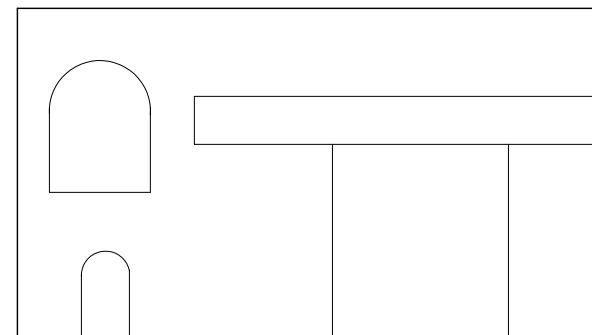
NORTH ELEVATION



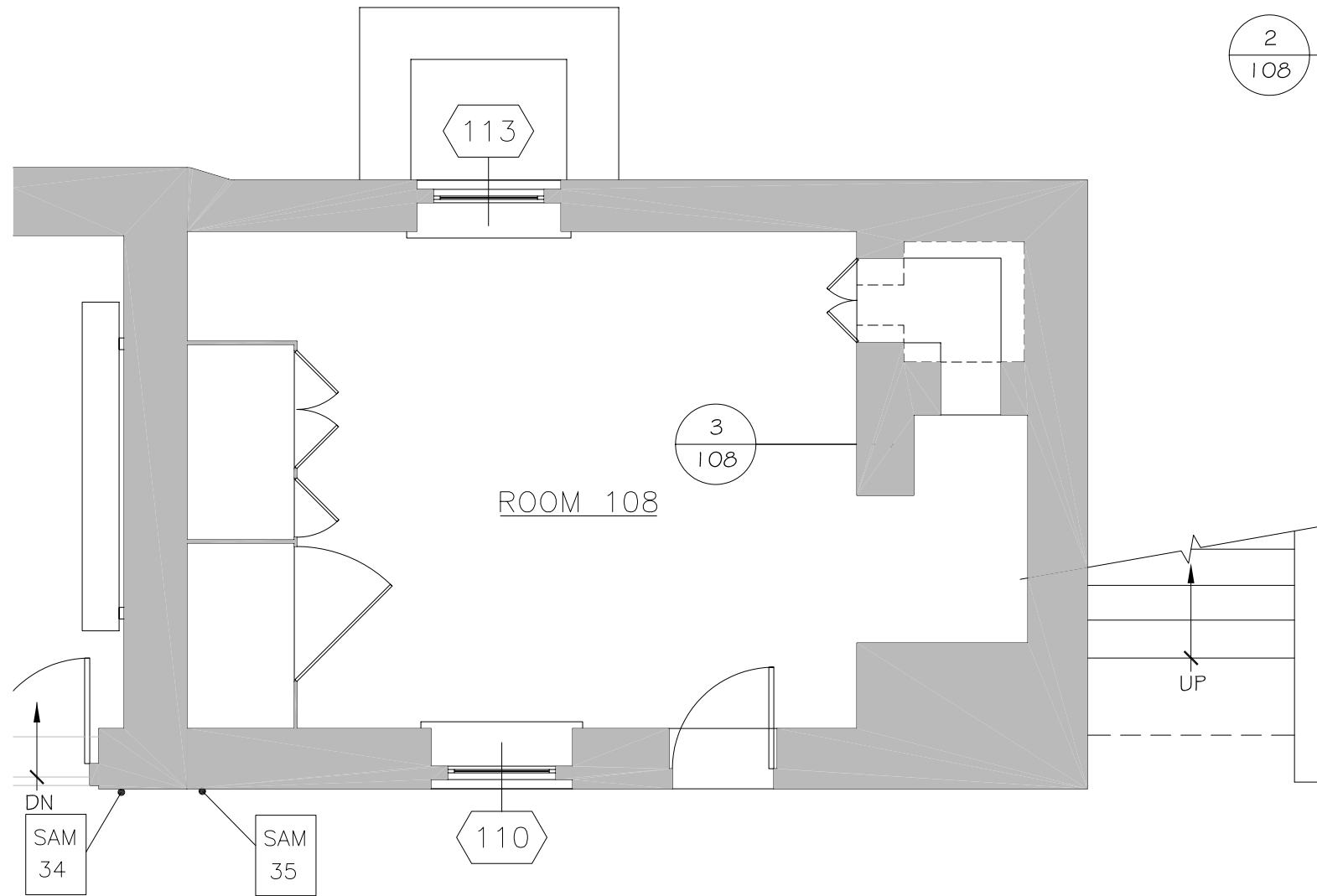
WEST ELEVATION




SOUTH ELEVATION





EAST ELEVATION





**LEGEND:**

NUMBER & DIRECTION OF PHOTO  000a

NOTE FROM DESCRIPTION NARRATIVE  1 000

MATERIAL SAMPLE LOCATION  SAM 00

 N

 SCALE OF FEET

### Room 109 -

Room 109 represents the original springhouse. This building may also be the "Milkhouse" referred to in the 1798 U.S. Direct Tax.



### Floor

- Concrete floor with an inset trough for the spring water. The original floor was most likely brick. The precise date of the concrete floor installation is not known. (Photo 109a, Note 1/109)

### Walls

- All walls are plastered directly onto stone masonry with 2 layers of plaster. The top layer is a high cement-content plaster/stucco. The plaster is deteriorated, missing in many areas, and moldy due to the high moisture level of the springhouse interior. (Photo 109b)
- There are several significant cracks in the walls, particularly under the two windows and in the southwest corner. (Photo 109b, Note 2/109)
- The north wall retains a fairly high exterior grade and has a slight bulge in the center of the wall. There are no weep holes in the wall to relieve hydrostatic pressure although recent drainage improvements undertaken by the Park may help alleviate some of the pressure.
- The north wall has a pipe penetrating the wall that brings the spring water to the springhouse from a holding cistern further up the hill. (Photo 109a, Note 8/109)
- The south wall has a pipe penetrating the wall that allows the spring water to exit the springhouse and discharge southward towards Yellow Springs Road. (Photo 109b, Note 3/109)

### Ceiling

- The ceiling is a 20<sup>th</sup> century cement plaster on sawn lath.

### Doors

- The only door into the spring house is a vertical board and batten door. This door is a 20<sup>th</sup>-century replacement. The door frame is not as recent as the door but also appears to be a non-original frame. (Photo 109c, Note 4/109)

### Windows

- Window 111: 4-light wood casement window which appears to be a 20<sup>th</sup>-century replacement. The masonry window opening appears in a c. 1925 photograph. A new exterior screen was installed in late 2005. (Photo 109c, Note 5/109) (Archive Photo 7)
- Window 112: 4-light wood casement window which appears to be a 20<sup>th</sup>-century replacement. Unfortunately, in the c. 1925 photograph that shows this side of the springhouse, the center of the wall is blocked by a tree and it is difficult to see if

the masonry window opening is original. A new exterior screen was installed in late 2005. (Note 6/109) (Archive Photo 7)

Millwork

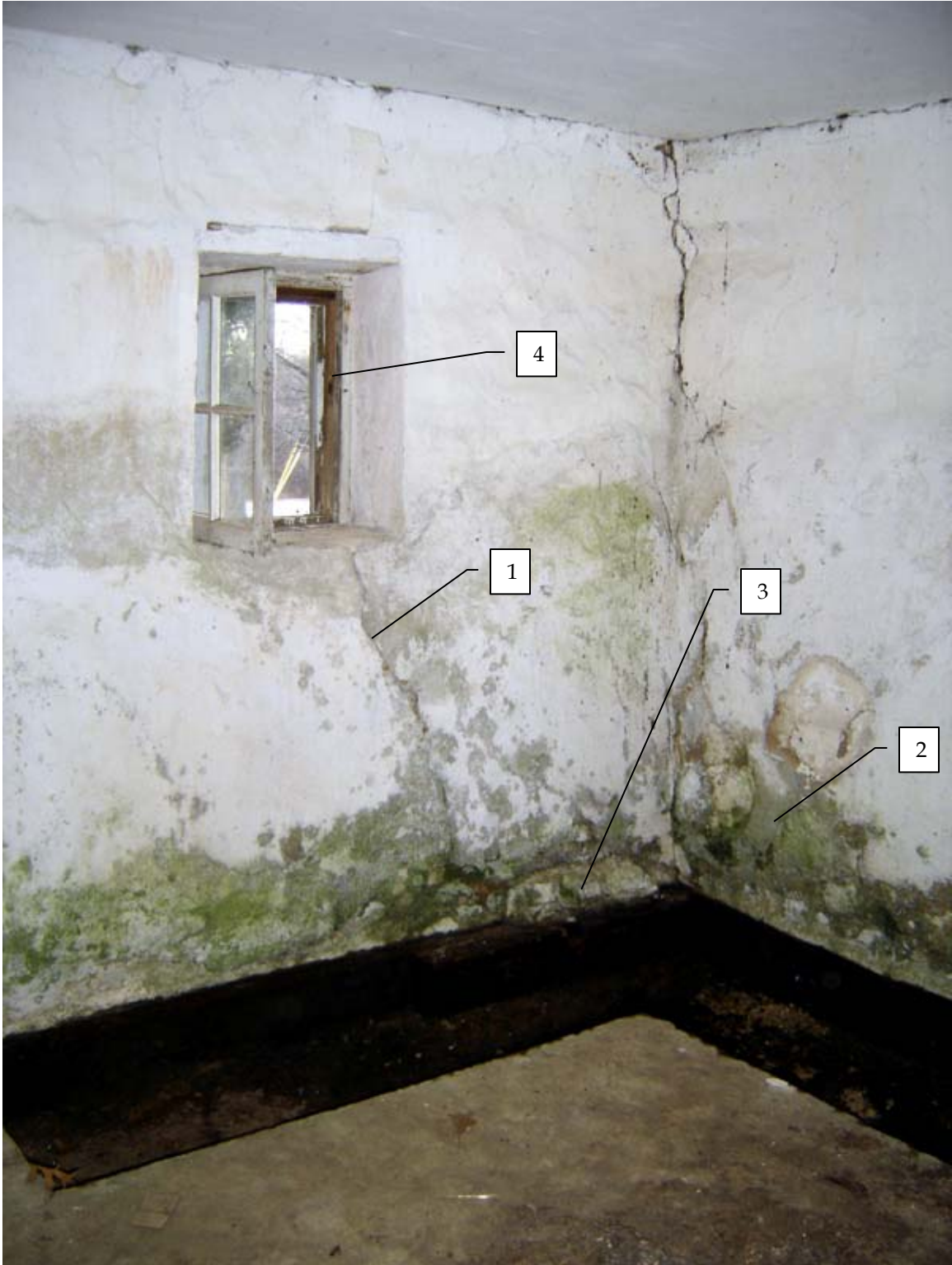
- Shelving on the east wall is not original. It consists of nominal 2x4 vertical supports and brackets and nominal 1x10 shelves. (Photo 109c, Note 7/109)



**Photo 109a** - Segment of springhouse interior, Room 109, looking northwest.

1. Concrete floor.
2. Perimeter trough.
3. Inlet pipe.





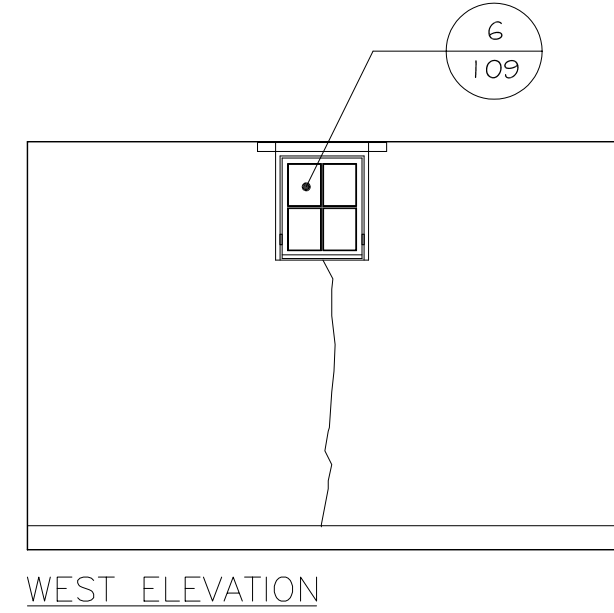
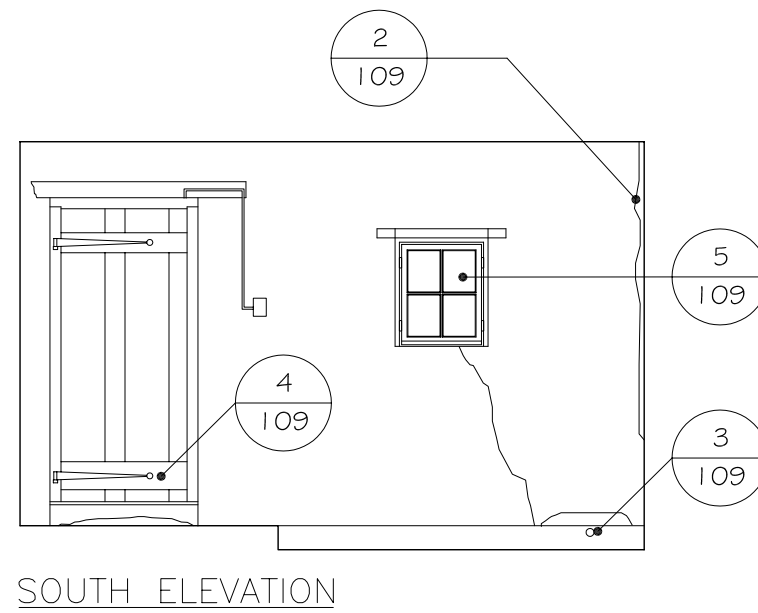
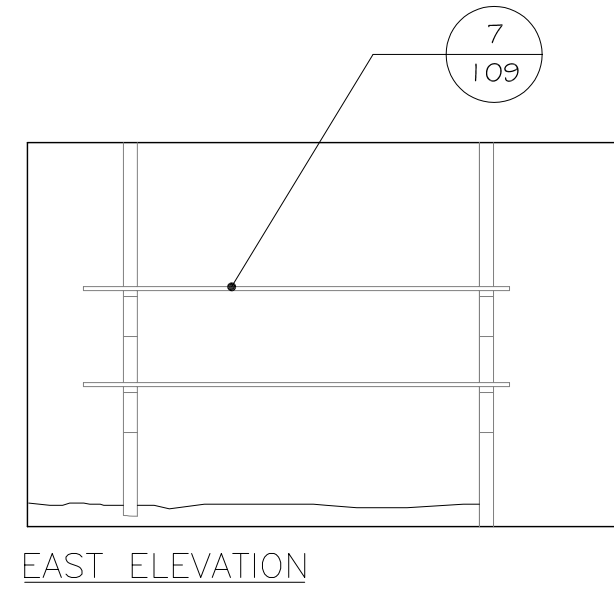
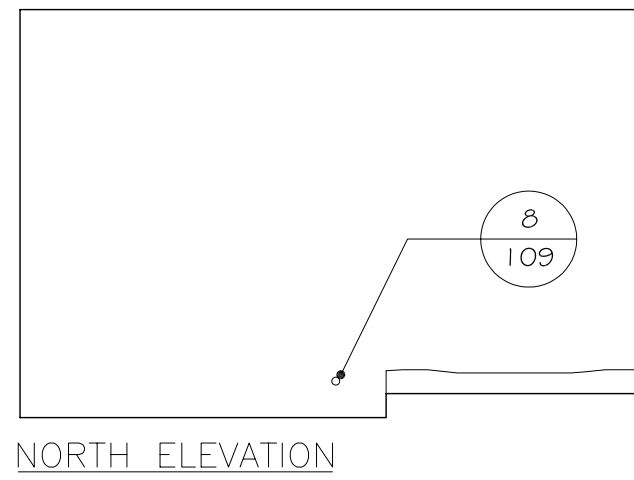
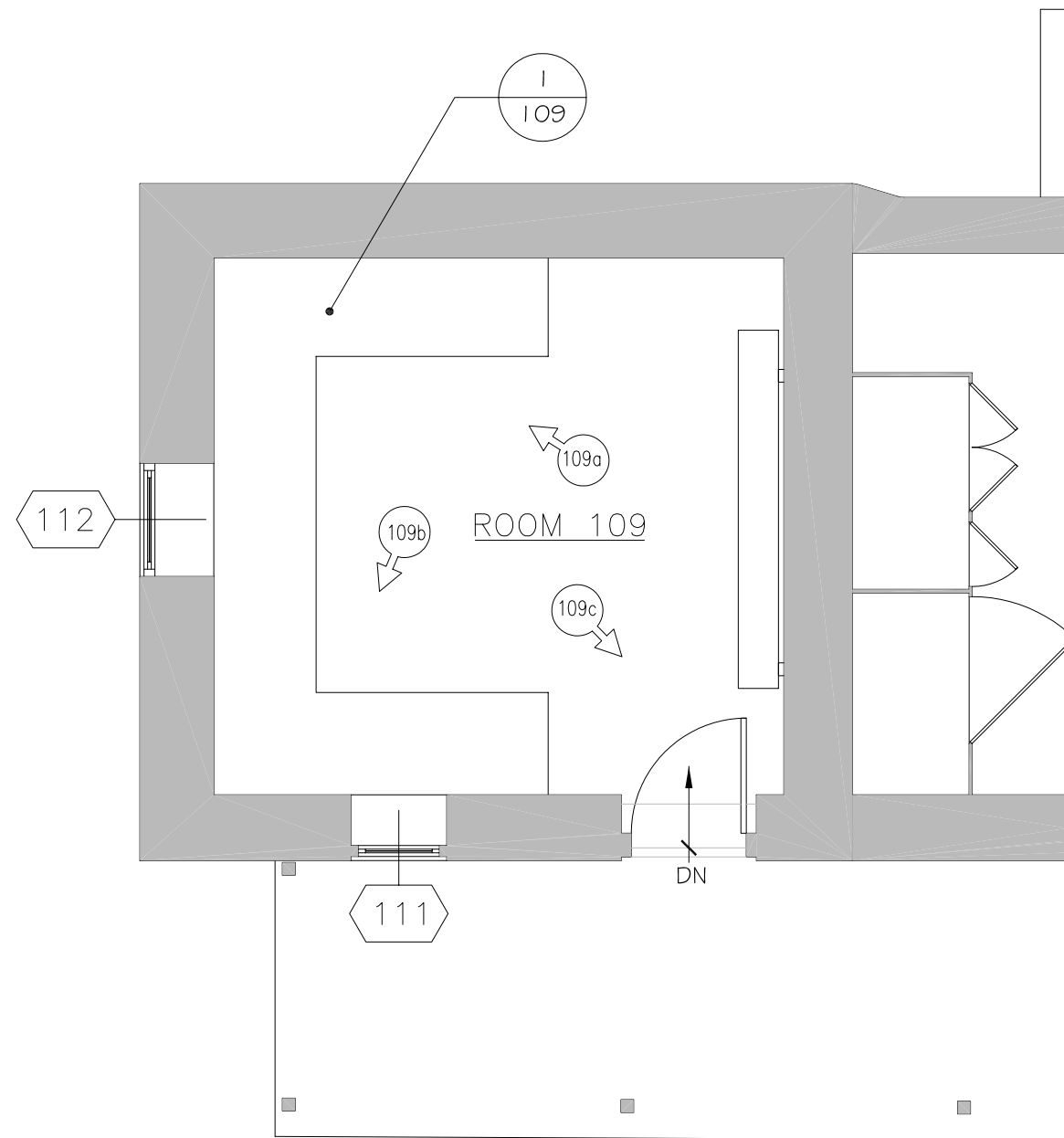
**Photo 109b** – Segment of springhouse interior, Room 109, looking southwest.

1. Masonry cracks.
2. Biological growth on interior wall surfaces.
3. Outlet pipe.
4. South window.




**Photo 109c** - Segment of springhouse interior, Room 109, looking southeast.


1. 20<sup>th</sup>-century board-and-batten door.
2. 20<sup>th</sup>-century shelving.




**LEGEND:**

N

NUMBER & DIRECTION OF PHOTO  000a

NOTE FROM DESCRIPTION NARRATIVE  1 000

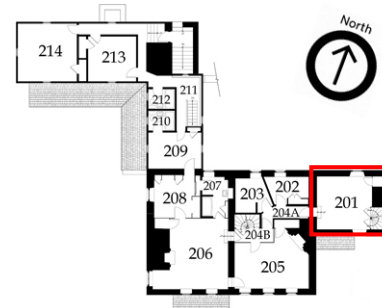
MATERIAL SAMPLE LOCATION  SAM 00

2 0 2 4

SCALE OF FEET

### Room 201 -

Room 201 is located on the second floor of the east addition, constructed circa 1830. There is a winder stair in the southeast corner of the room and a built-in cupboard at the north side of the chimney mass along the east exterior wall. This room is one of the most intact in the entire structure.



### Floor

- Random-width floorboards run east-west the full length of room.
- Floorboards are face nailed using machine-cut nails with hand-wrought T-head nails and appear to be original to the east addition (c. 1830).
- Floorboards have varnish-like finish.
- Surface damage due to water infiltration is apparent in the southeast quadrant of the room. (Photo 201b, Note 1/201)
- Floorboards near stair are also cupped from standing water. (Photo 201b, Note 2/201))
- There is an unexplained floor patch at east wall. (Note 3/201)

### Walls

- All walls are plastered directly onto stone masonry with 2 layers of plaster.
- There are several cracks in the plaster, particularly above windows and below ceiling joists. (Note 5/201)
- Several areas demonstrate significant plaster efflorescence and mold growth, particularly on the surface of the west wall. This is likely due to water infiltration from failed or non-existent flashing between the roofs of the east addition and the main block. (Note 6/201)

### Ceiling

- The ceiling features exposed wood joists, without beaded or chamfered edges. Several of the joists have jagged edges where bark has fallen off of the member. (Photo 201a)
- There are no plaster or lath marks on the joists, indicating that the joists were originally exposed. This is further supported by exposure of the original wall plaster layer which runs up between the floor joists. (Photo 210d)
- The undersides of the beaded attic floor boards are exposed.
- Ceiling joists appear to have been refinished with a varnish-like finish. Presumably, this was done by the Ligget family during their ownership.
- Ceiling joists are coated with green mold. Water infiltration from leaks in the roof and attic window above has saturated the attic flooring promoting the growth. In addition, it is possible that the surface finish is sustaining the mold. (Photos 201a & 201b)

### Doors

- The two stair doors are beaded board and batten doors with HL hinges. The doors appear to be original c. 1830 with evidence of earlier hardware. The hinges



are fastened with a combination of clinched rose head nails and screws, and are reproductions. (Photo 201b, Note 7/201)

- The doors are in generally good condition, although each needs adjustment and edge planning to operate smoothly.
- Head trim at the west doorway is loose. (Note 12/201)

### Windows

- Window 201: 6/6 single-hung wood window. Sash operates with a tape balance. Sill and lower sash components are significantly water damaged and/or rotted. Window has splayed plaster jambs with wood trim at the edge. Profile and detail is consistent with the original construction period of the east addition (c. 1830). There are holes in the plaster on both sides of the window sill which suggest that there may have been a different sill when the room was first plastered. However, all other c. 1830 plaster abuts the existing trim. (Photo 201, Note 8/201)
- Window 223: 6/6 single-hung wood window. Sash operates with a tape balance. Sash operation is stiff and bottom rail is beginning to rot. Wood sill is worn due to weather infiltration. Exterior glazing putty is 100% loose or missing. Window has splayed plaster jambs with wood trim at the edge. Profile and detail is consistent with the original construction period of the east addition (c. 1830). Left side of window sill has a hole in the plaster. (Photo 201c, Note 9/201)

### Stairs

- Winder stairs down to the first floor and up to the attic are original to the east addition.
- Treads and risers are set into the plaster finish and fastened with hand-wrought nails. (Photo 201b)
- Stair wall enclosure is comprised of beaded boards.

### Millwork

- Baseboard in room is 6" wood base with ½" diameter bead. The baseboard is mounted directly to the stone walls and the plaster runs to the baseboard indicating that it is original to the east addition.
- Baseboard was removed on north and south walls to accommodate the installation of radiant baseboard heaters. (Photo 201a, Note 11/201)
- West baseboard has a 3-foot section that is rotted and loose. (Note 10/201)
- Cabinet on east wall appears to be original (c. 1830). Wall plaster abuts the cabinet door frame. The interior shelf, however, was added at a later date because the shelf supports are attached on top of the plaster interior. (Note 4/201)



**Photo 201a** – Interior view of Room 201, looking southwest.

1. Wood ceiling joists are exposed, plain sawn with wood tongue-and-groove ceiling above. The varnished surfaces of the wood joists exhibit significant mold growth in scattered locations.
2. Original c. 1830 wood baseboard replaced with radiant baseboard heater at south wall.
3. Plaster walls exhibit significant mold growth and damage from moisture infiltration.
4. Original c. 1830 random width wood floorboards.



**Photo 201b** – Winder stair (c. 1830) at southeast corner of Room 201, looking east.

1. Beaded wood doors appear to be original.
2. Treads and risers are set into plaster finish.
3. Moisture infiltration is significant as evidenced by damaged plaster, saturated and cupped wood flooring, and extensive mold growth.





**Photo 201c** - Interior view of Window 223, looking north.

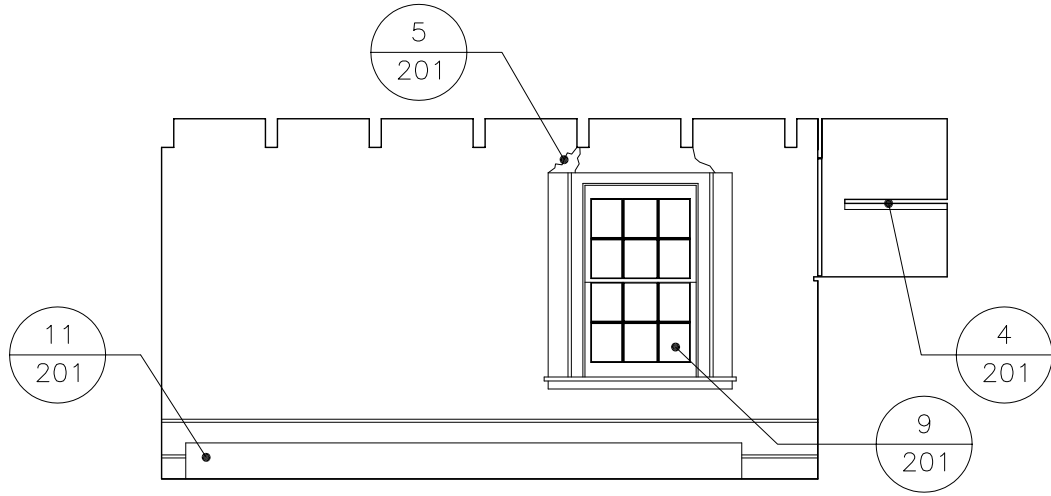
1. Splayed jamb with wood bead.
2. Original (c. 1830) wood sash and frame.



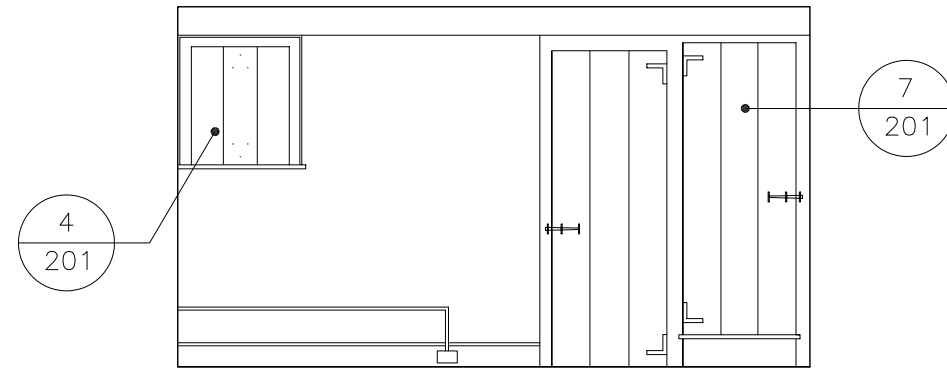
**Photo 201d** - Detail view of plaster at south wall, Room 201, looking south.

1. Original c. 1830 wall plaster runs between ceiling joists with no evidence of former plaster ceiling beneath joists.

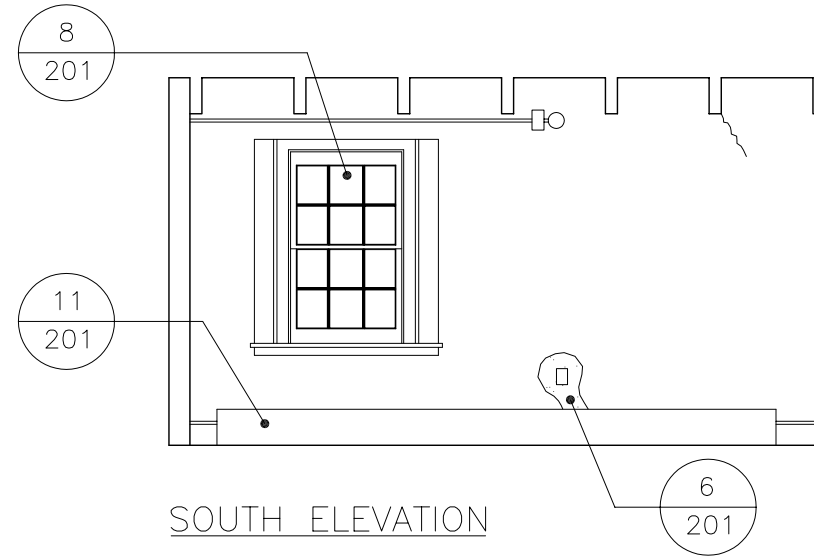




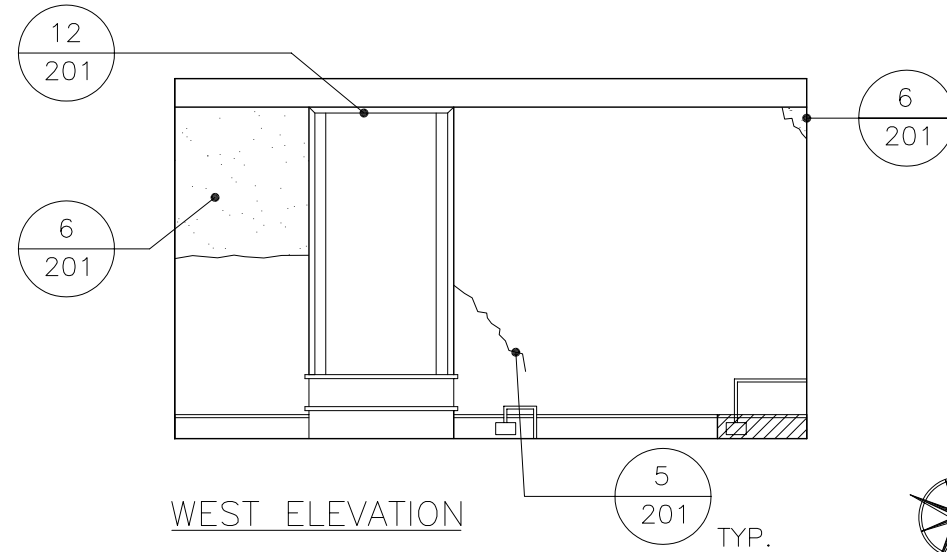
NORTH ELEVATION



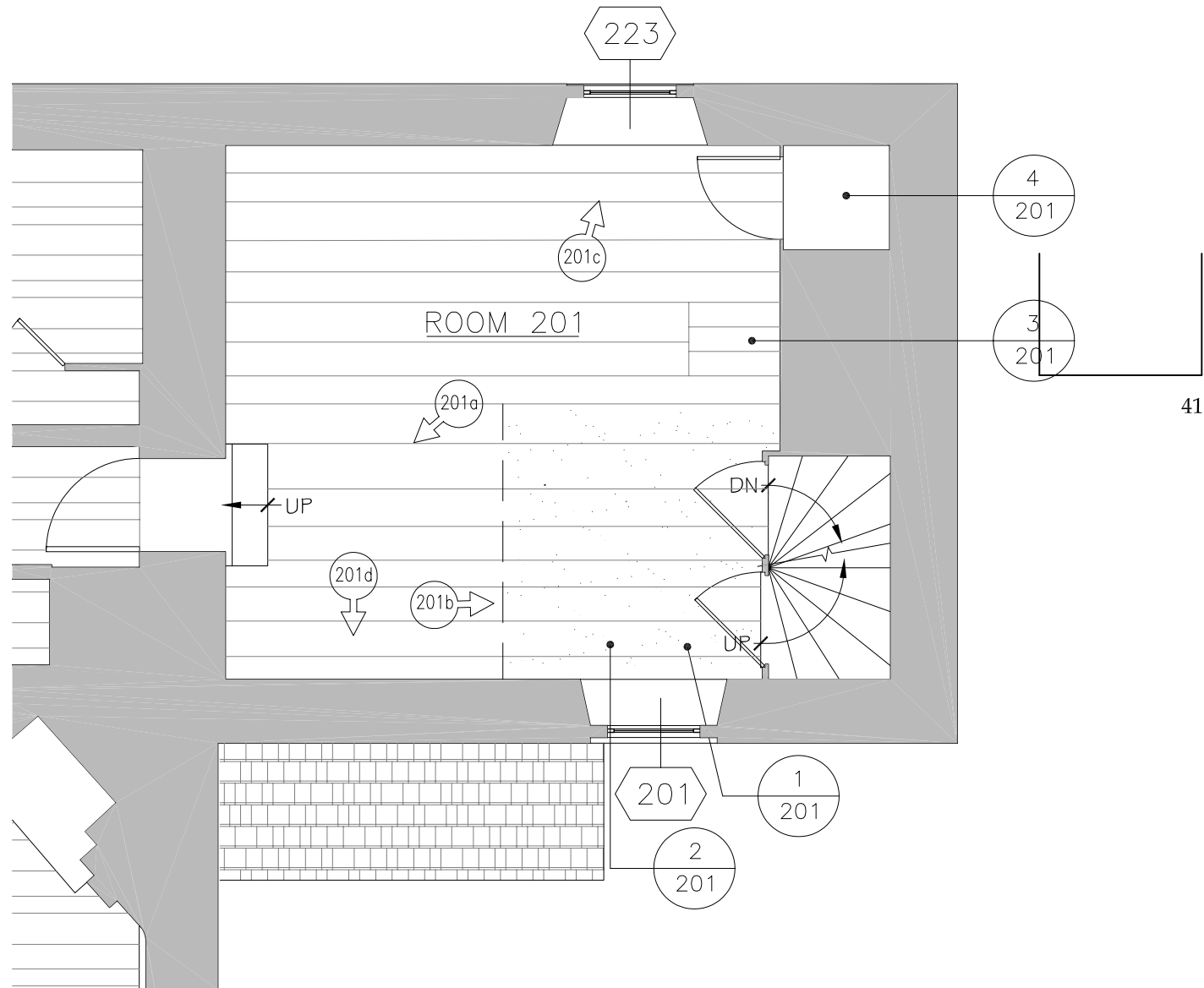
EAST ELEVATION






SOUTH ELEVATION



WEST ELEVATION



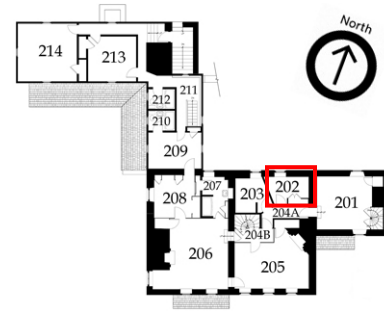
LEGEND:

- NUMBER & DIRECTION OF PHOTO  000a
- NOTE FROM DESCRIPTION NARRATIVE  1 000
- MATERIAL SAMPLE LOCATION  SAM 00



### Room 202 -

Located in the northeast corner of the original house, this room was created when the stud wall was installed to provide access to the east addition.



### Floor

- Random-width flooring extends into cedar closet. (Note 1/202)
- Floor is in good condition with a varnish-like finish.
- Underside of flooring is beaded although it was never exposed in the room below. Installation of this flooring is attributed to the Ligget family residency, c. 1926.

### Walls

- North and east walls have two layers of plaster on stone masonry walls.
- South wall is formed by a 20<sup>th</sup>-century cedar closet and door.
- West wall is comprised of 20<sup>th</sup>-century studs with drywall.
- Removal of east wall plaster did not reveal any infilled openings. (Note 2/202)

### Ceiling

- Plaster ceiling is cement-based plaster on a mixture of hand-split and sawn lath. The ceiling was probably re-plastered when the cedar closet and partition wall were installed.

### Doors

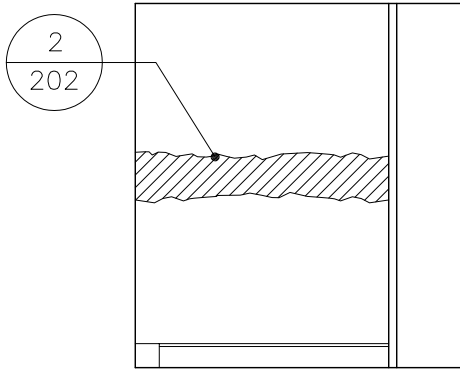
- Six-panel wood door appears to be a reproduction. The panel profiles are slightly different from the original doors at the stair.

### Window

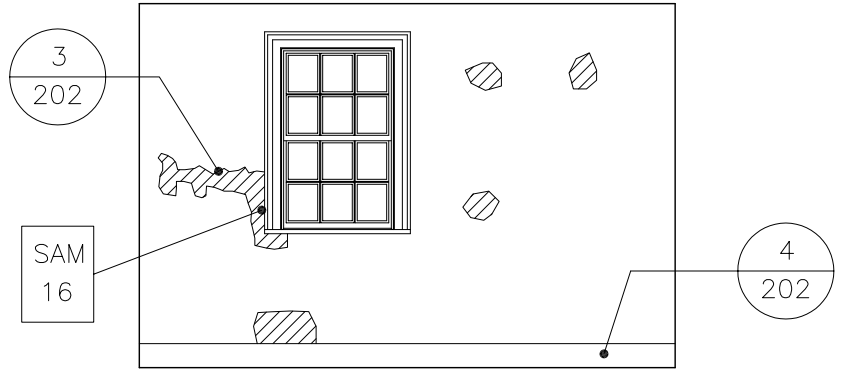
- Window 222: 6/6 single-hung wood window. All details of this window appear to be 18<sup>th</sup>-century. Investigation of the jamb revealed a slightly rounded plaster jamb as the original 1769 detail. The rounded jamb is present on both jambs. (Note 3/202)
- Plaster removal on the north and east masonry walls revealed no evidence of other window openings.

### Millwork

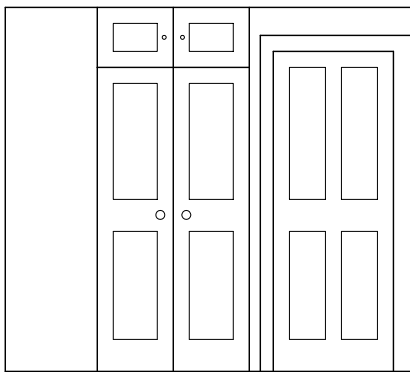
- Cedar closet on south wall features 20<sup>th</sup>-century detailing.
- Baseboard on west wall is not original, but attempts to match the 18<sup>th</sup>-century baseboard.
- Beaded baseboard on the north and east walls appears to be 18<sup>th</sup>-century and aligns with the earlier plaster layer. Baseboard is loose, but extant behind the radiator pipe box on the north wall. (Note 4/202)



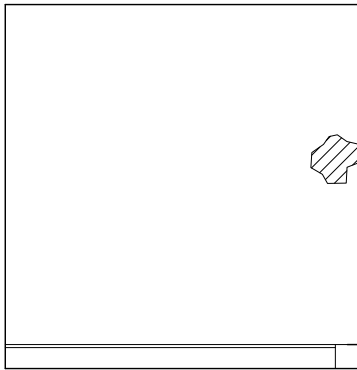
EAST ELEVATION



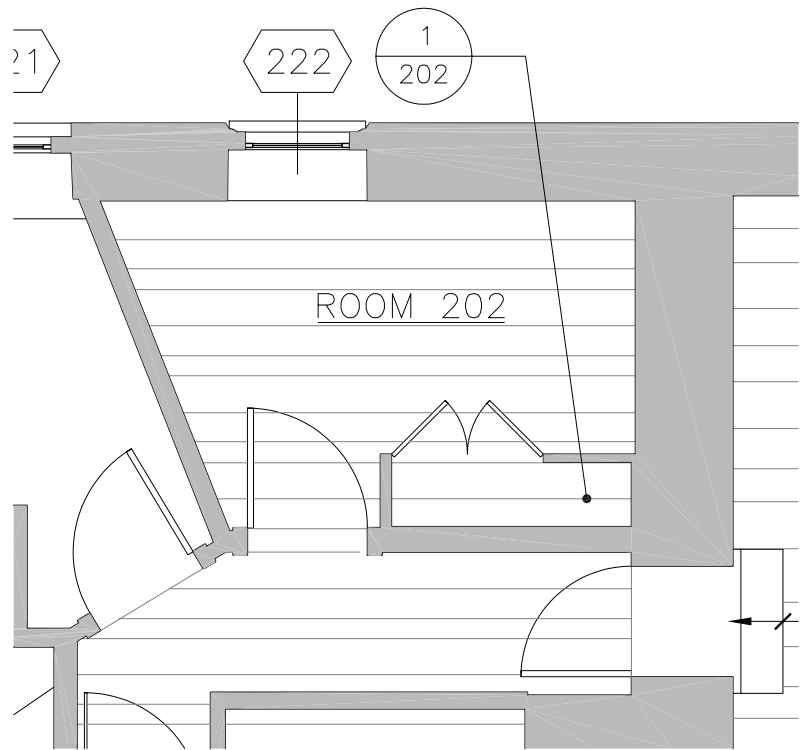
NORTH ELEVATION



SOUTH ELEVATION



WEST ELEVATION



LEGEND:

NUMBER & DIRECTION OF PHOTO: (0000) with arrow pointing right  
 NOTE FROM DESCRIPTION NARRATIVE: (1) / (000) with arrow pointing right  
 MATERIAL SAMPLE LOCATION: SAM 00 with arrow pointing right

SCALE OF FEET

Historic Structure Report  
**STIRLING'S QUARTERS**  
 Valley Forge National Historical Park

**JOHN MILNER ARCHITECTS, inc.**

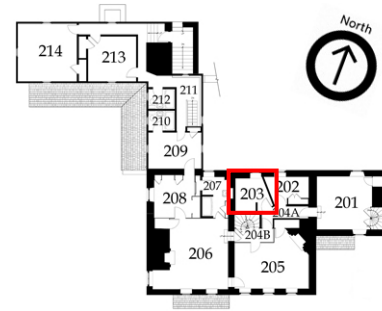
104 Lakeview Drive, Chadds Ford, Pennsylvania 19317 • (610) 388-0111

PHYSICAL  
 DESCRIPTION

ROOM 202

### Room 203 -

The northwest corner of the main block was partitioned off as a bathroom in the 1920s by the Ligget family. It was remodeled by the National Park Service in the 1970's for use by seasonal employees.



### Floor

- Composite flooring tile has been removed. Mastic still present on top of underlayment.

### Walls

- North masonry wall has been furred out with 2x4 studs and drywall. Behind the studs are two layers of plaster on the stone wall.
- East wall is modern 20<sup>th</sup>-century stud construction with gypsum drywall.
- South wall is covered by the modern bathtub and surround.
- West wall has been furred out with 2x4 studs and drywall.
- Removal of a recessed medicine cabinet on the west wall revealed a doorway. Wood nailers for door trim are extant and there is a plaster line on both sides indicating the trim. There are several layers of paint on this wall surface as well as numerous disturbances for electrical and lighting work. The doorway was likely cut into the existing masonry wall c. 1810 to provide access into the expanded west wing. (Photo 203a, Note 1/203)
- Plaster on north and west walls is significantly deteriorated due to the various bathroom remodeling phases.

### Ceiling

- Sawn 20<sup>th</sup>-century wood lath and plaster.

### Doors

- South bathroom door is 20<sup>th</sup>-century. Panel profiles do not match any other doors.

### Windows

- Window 221: 6/6 single-hung wood window. General detailing of the window is not consistent with the other 18<sup>th</sup>-century windows. Plaster removal revealed that the jambs had pieces of brick on both sides and a cement sill. This window is not shown on the 1926 renovation drawings and it is believed that the Ligget family added this window, and several others, to their scope of work.

### Millwork

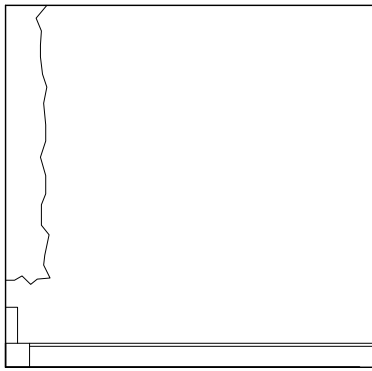
- All baseboards are 20<sup>th</sup>-century.



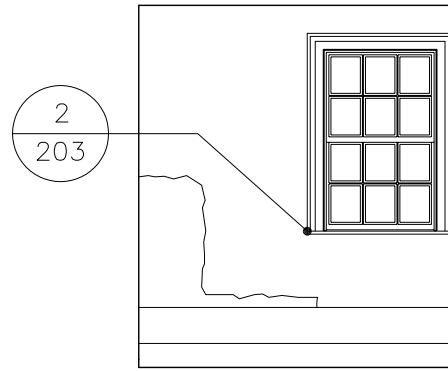


**Photo 203a** – View of west wall of Room 203, looking west. Former doorway between Rooms 203 & 207 located behind 20<sup>th</sup>-century renovations.

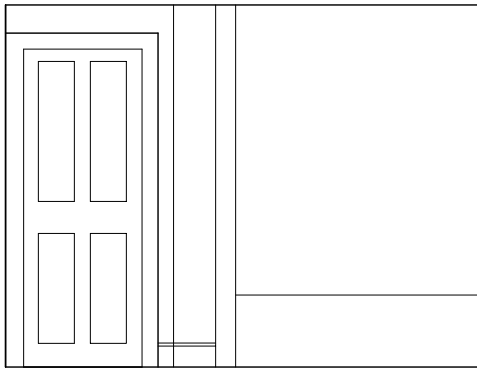
1. Late 20<sup>th</sup>-century stud wall with gypsum wallboard partially demolished.
2. Former 19<sup>th</sup>-century doorway infilled during 1926 renovations.
3. Wood nailer set in masonry to attach 19<sup>th</sup>-century (c. 1810) door frame.



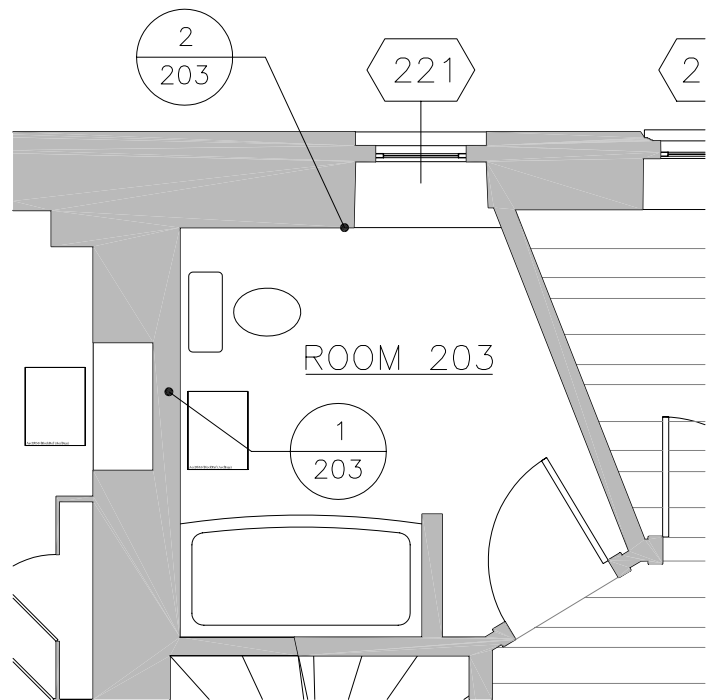
EAST ELEVATION



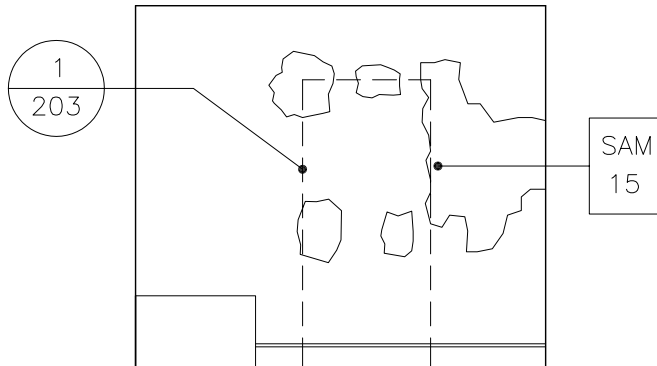
NORTH ELEVATION



SOUTH ELEVATION



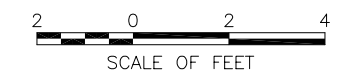
ROOM 203



WEST ELEVATION

LEGEND:

- NUMBER & DIRECTION OF PHOTO (0000)
- NOTE FROM DESCRIPTION NARRATIVE (1/000)
- MATERIAL SAMPLE LOCATION (SAM 00)



Historic Structure Report  
**STIRLING'S QUARTERS**  
 Valley Forge National Historical Park

**JOHN MILNER ARCHITECTS, inc.**

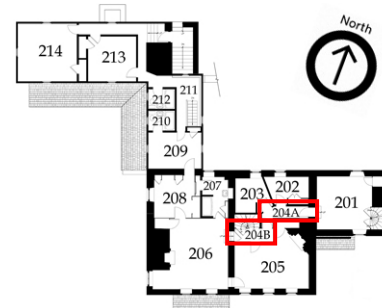
104 Lakeview Drive, Chadds Ford, Pennsylvania 19317 • (610) 388-0111

PHYSICAL  
 DESCRIPTION

ROOM 203

### Rooms 204A & 204B - (Hall)

The two hallways on the second floor were created in the 1920s during the extensive renovations undertaken by the Liggett family.



### Floors

- Underside of flooring is beaded although it was never exposed in the room below (see Room 102). Installation of this flooring is attributed to the Liggett family residency, c. 1926.
- Random-width floorboards face-nailed with cut flooring nails.
- Floors are in good condition with varnish-like finish.

### Walls

- The molding profiles and design of the partition wall surrounding the winder stair suggest that this wall is original. (Note 2/204)
- South hall wall adjacent to Room 205 is not original and was added in the c. 1926 renovations.
- South wall forming back of closet is not original. It is constructed of 20<sup>th</sup>-century studs with sawn lath and cement-based plaster.
- The chimney flue is evident in the south plaster wall where it angles towards the summer beam. There are two layers of plaster on the flue. The base plaster on this flue matches the base plaster on the other walls and suggests that this room never had a fireplace. The north chamber of the main block may have been heated originally by a five-plate, or jamb, stove as suggested by William Currie's estate Inventory which includes a listing for an "Open Stove." (Note 6/204)
- At the base of the chimney flue, there is a line in the bottom plaster layer where the plaster abutted the original baseboard. The original baseboard has been removed and the space filled with a 20<sup>th</sup>-century plaster that matches the top layer of plaster. This is strong evidence that there was never a corner fireplace in the northeast room. (Photo 204a, Note 7/204)

### Ceilings

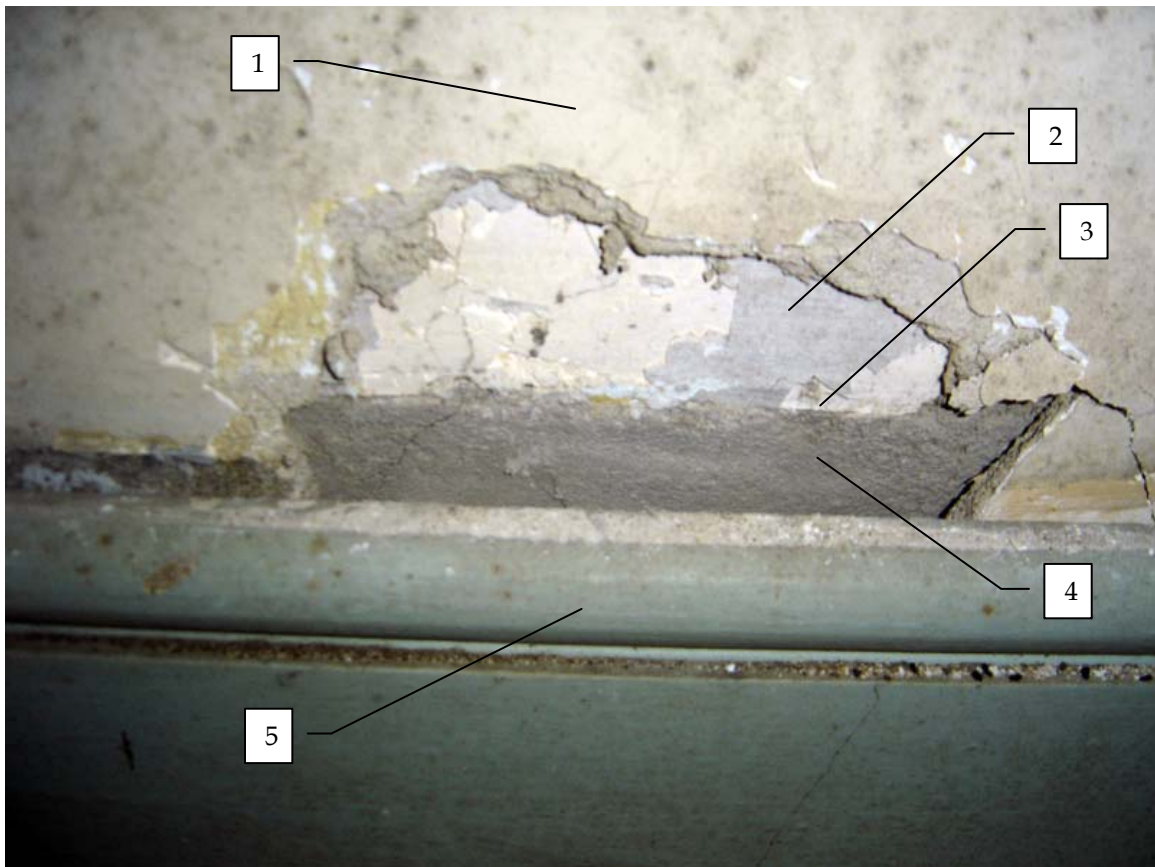
- Ceilings are thin plaster over sawn lath installed with 20<sup>th</sup>-century lath nails.
- Ceiling joists, spanning from the north wall to the central summer beam, appear sawn although saw marks are very faint.
- All but one ceiling joist have only one plaster and lath mark which further suggests that the joists are replacements, likely dating to the extensive Liggett-era renovations. The one joist with a second faint plaster line might be a salvaged joist from another location. (Photos 204b & 204c)

### Doors

- West door into Room 206 is not original. Since it is believed that the original kitchen wing was only one-story in 1769, this door would not have fit. (Note

3/204). It was constructed sometime between 1810 and 1926 and we believe that it was circa 1810 when the west wing was raised to two full stories in height.

- Winder stair door to attic is original.
- Winder stair door to first floor is missing, but the hinge marks are evidence that a door existed.
- Door in hall between 204A and 204B appears to be original. The molding surrounding the opening, however, differs from the winder stair doors and may suggest that the opening was added at a later date. In addition, if the north closet door in Room 205 is original as thought, then there would be two adjacent doors into the north room. Future removal of the molding and the summer beam covering boards may reveal additional evidence. (Note 4/204)
- East door to east wing is not original. This doorway was cut in to provide access to the c. 1810 addition. This opening is not shown on the 1926 renovation drawings and it is believed that the Ligget family added this doorway to their scope of work. (Note 5/204)



**Photo 204a** - Detail of plaster wall and baseboard at back of chimney mass, south wall, Room 204A, looking south.

1. Cement-based, 20<sup>th</sup>-century plaster application.
2. Original first-layer plaster.
3. Line in original first-layer plaster indicates where original baseboard was removed.
4. Cement-based, 20<sup>th</sup>-century plaster infill.
5. Replacement baseboard installed over cement-based plaster.



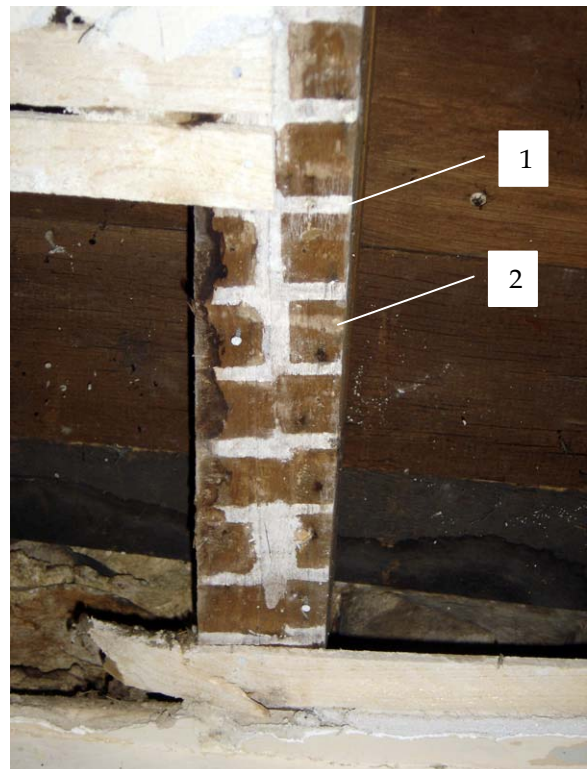


**Photo 204b** – View of exposed ceiling joists, Room 204A, looking southeast.

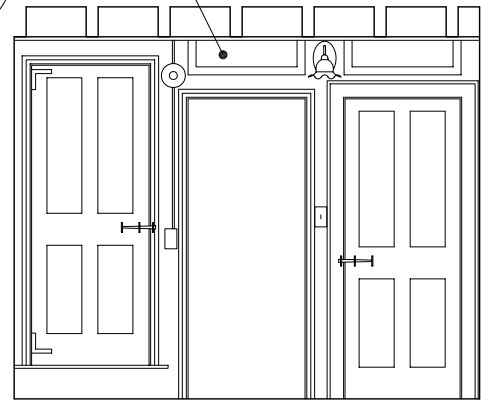
1. Typical replacement joist.
2. Existing plaster ceiling features sawn lath and 20th-century fasteners.

**Photo 204c** –  
Detail view of atypical ceiling joist, Room 204A, looking up.

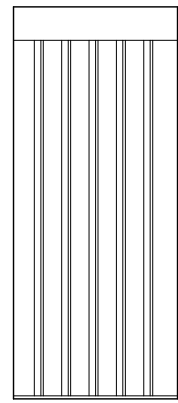
1. Stains on joist from most recent plaster installation.
2. Faint stains are from a previous plaster installation indicating that this one joist may have been recycled.



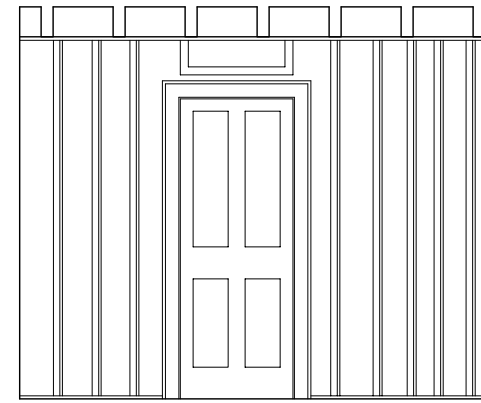
2  
204



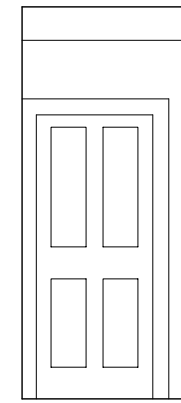
204B NORTH ELEVATION



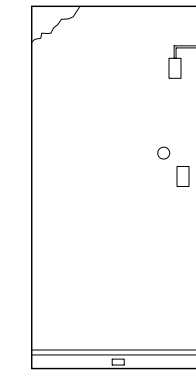
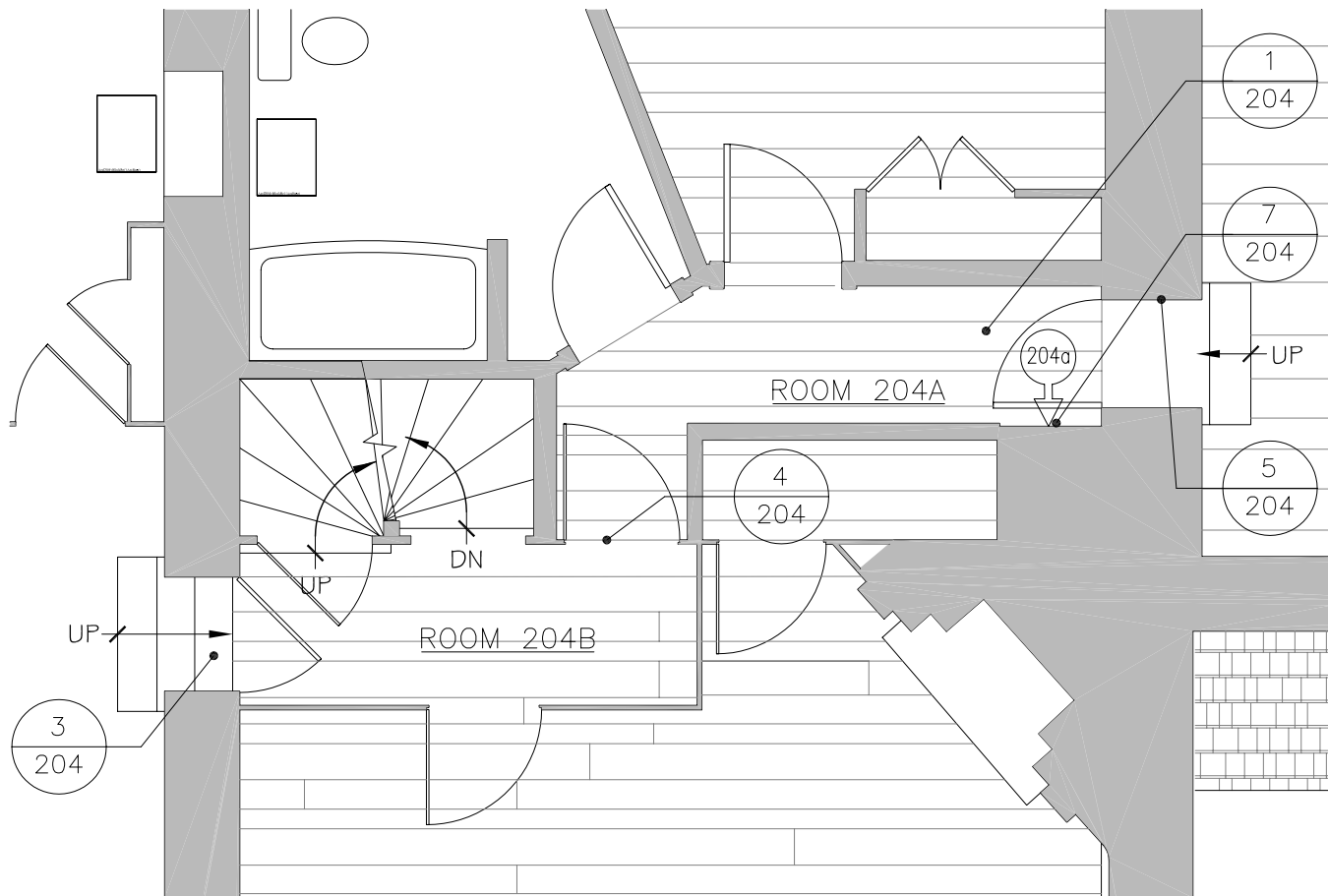
204B EAST ELEVATION



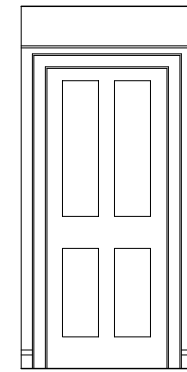
204B SOUTH ELEVATION



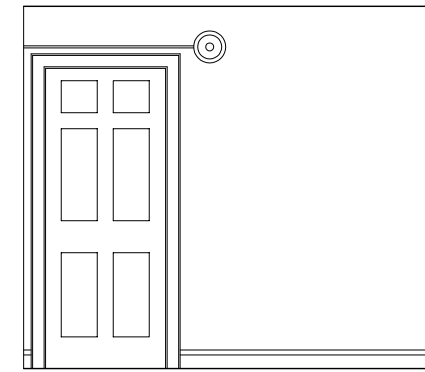
204B WEST ELEVATION



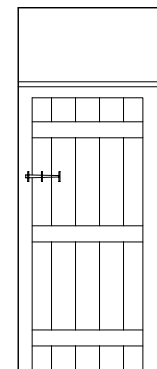
204A WEST ELEVATION



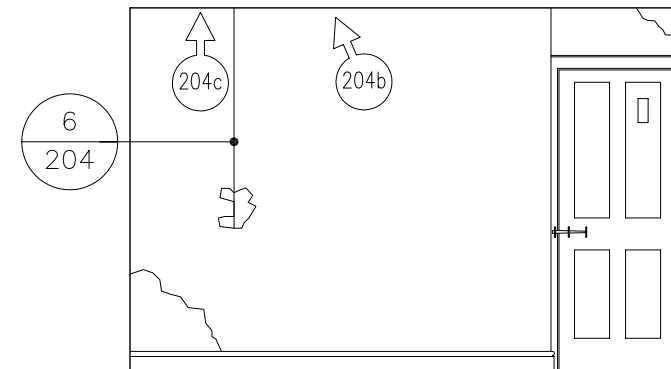
204A NORTHWEST ELEVATION



204A NORTH ELEVATION



204A EAST ELEVATION

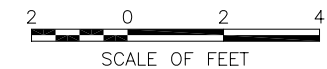


204A SOUTH ELEVATION



LEGEND:

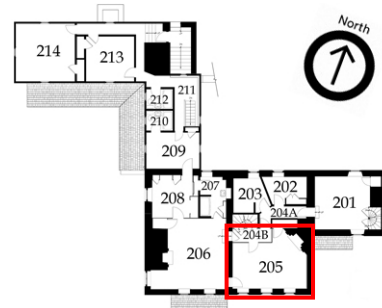
- NUMBER & DIRECTION OF PHOTO (000a) ↗
- REFERENCE NOTE FROM DESCRIPTION NARRATIVE (1 000) ○
- NUMBER & LOCATION OF MATERIAL SAMPLE (SAM 00) □



SCALE OF FEET

### Room 205 -

Room 205 retains much of its original 18<sup>th</sup>-century elements including sections of chair rail, the south windows, and the corner fireplace. The more recent addition of the hallway partition wall has reduced the size of the room.



### Floor

- Underside of flooring is beaded although it was never exposed in the room below (see Room 103). Installation of this flooring is attributed to the Ligget family residency, c. 1926. (Photo 205a)
- Random-width floorboards face-nailed with cut flooring nails.
- Floors are in good condition with varnish-like finish.

### Walls

- North beaded-board wall forming hall is not original to 1769. Although very similar in profile to the winder stair boards, they are slightly different and have fewer paint layers. (Photo 205a, Note 1/205)
- Beaded-board wall forming closet front appears to be original because the original plaster of the corner fireplace abuts the door jamb. In addition, the plaster on the fireplace masonry, when viewed from the closet interior, appears to have the exact impression of the partition board. (Photo 205b)
- Panel above closet door is cracked. (Photo 205a, Note 7/205)
- East, south and west walls have two layers of plaster on stone masonry walls.
- Plaster has cracks on all walls. (Note 2/205)
- Plaster has areas of moisture damage and efflorescence. (Note 3/205)

### Ceiling

- Ceiling joists are exposed with the underside of the attic flooring visible. There are no lath marks or nail holes suggesting that the joists were always exposed.
- The joists have been cleaned and refinished, presumably by the Ligget family.

### Doors

- North door is a four-panel door introduced with partition wall. (Photo 205a)
- West closet door is not original. This doorway appears to have been cut into the masonry wall as access between Rooms 205 and 206. The closet infill must have occurred simultaneously or after the doorway between Rooms 204 and 206 was introduced. (Note 4/205)
- North closet door appears original. (Note 5/205)

### Windows

- Window 202: 6/6 single-hung, wood window. Appears to be original frame in original masonry opening. Sill and bottom sash are deteriorated. (Note 6/205)
- Window 203: 6/6 single-hung, wood window. Appears to be original frame in original masonry opening. Sill and bottom sash are deteriorated. (Note 6/205)

- Window 204: 6/6 single-hung, wood window. Appears to be original frame in original masonry opening. Sill and bottom sash are deteriorated. (Note 6/205)

#### Millwork

- Most of the original baseboard on the east and south walls has been removed to accommodate baseboard radiators and a pipe cover "box."
- Chair rails on south and east walls appear original. A section on the east wall is damaged by insects. (Photo 205c, Note 8/205)

#### Fireplace

- Framing at both ceiling and floor confirm that corner fireplace is original to the structure.
- Mortar hearth appears to be from the 18<sup>th</sup> century. It is cracked and loose in several areas. (Photo 205d)
- The mantel is not original. The original layer of plaster continues behind the present mantel. Full removal of the mantel may reveal the outline of an earlier mantel or indicate that there was only a mantelshelf. (Photo 205c)
- Inside closet, there is a line in the original plaster layer relating to the original baseboard. The existence of an early plaster and a baseboard on the south and east closet walls indicates that these walls were always exposed and there was never a north corner fireplace on the second floor. (Photo 205e)





**Photo 205a** - View of north wall of Room 205, looking northwest.

1. Board partition wall was introduced sometime after original construction period. It is most likely a 20<sup>th</sup>-century modification made during the Liggett tenure.
2. Four-panel wood door was most likely added as part of the c. 1926 renovations, along with the board partition wall that separates the current hallway.
3. Segment of closet wall may be original.
4. Random-width wood flooring is not original, likely added as part of the c. 1926 renovations to the building.



**Photo 205b** – Detail view of plaster at door jamb of closet, Room 205, looking northwest.

1. East jamb of closet door.
2. Original first-layer plaster abuts existing door jamb.



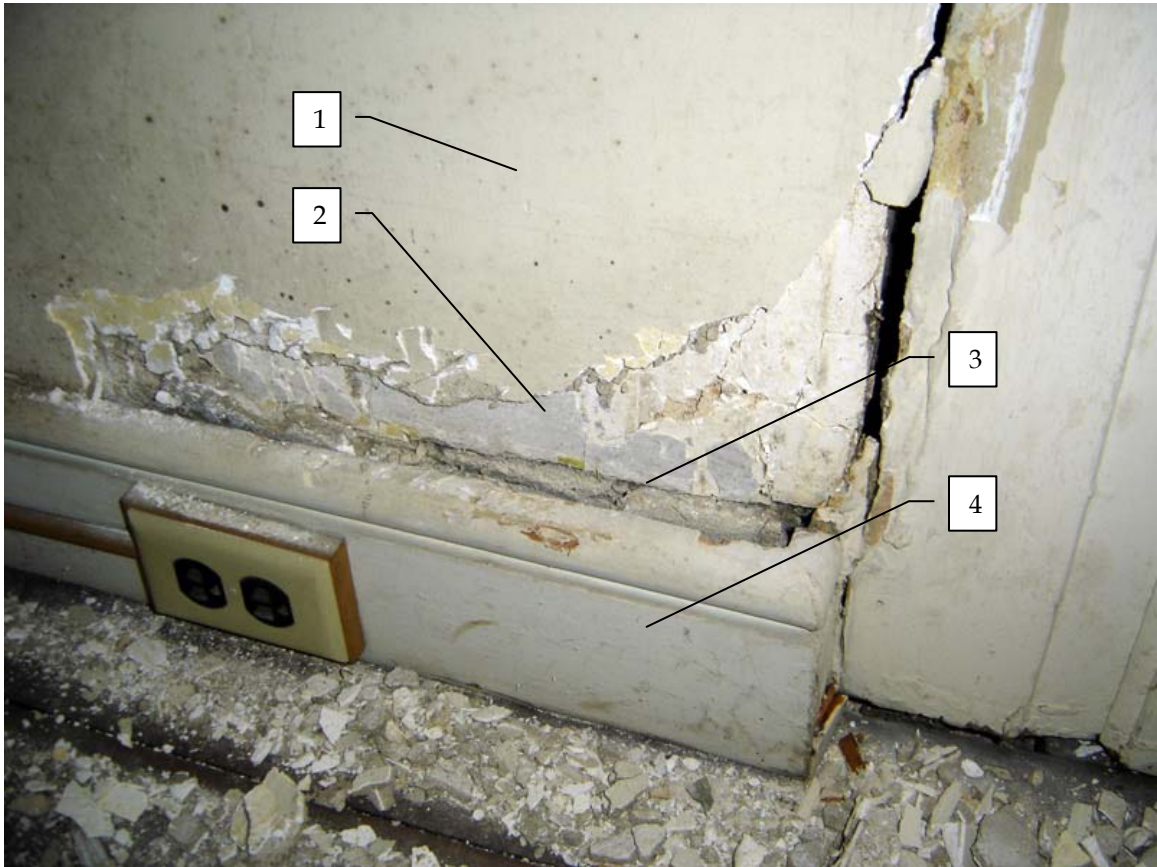
**Photo 205c** – View of east wall of Room 205, looking northeast.

1. Wood mantel added as part of the c. 1926 renovations.
2. Chair rails at east and south walls appear to be original, c. 1769.
3. Corner fireplace is original, c. 1769.

**Photo 205d** –  
Detail view of  
mortar hearth at  
corner fireplace,  
Room 205.  
Hearth is cracked  
and damaged.



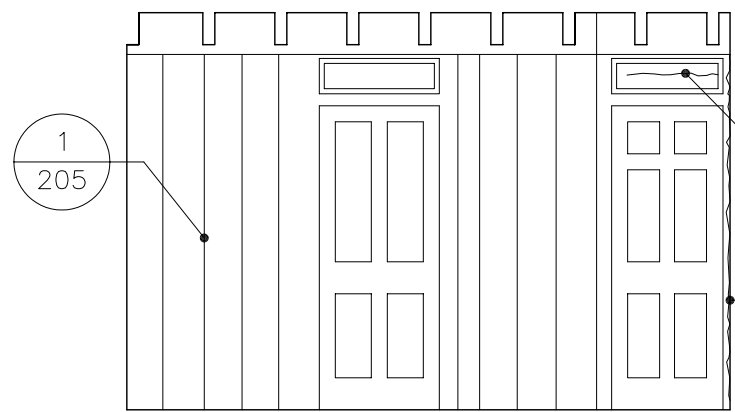




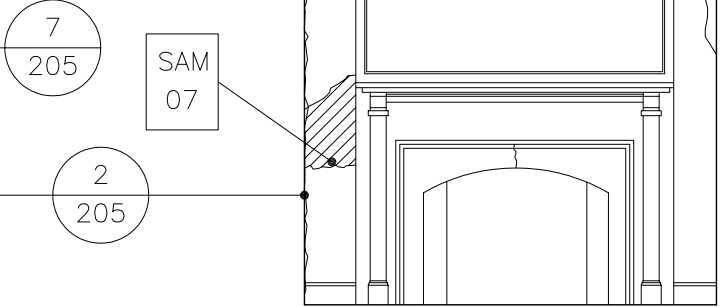
**Photo 205e** – Detail view of plaster and baseboard at south wall of closet in Room 205, looking south.

1. Cement-based, 20<sup>th</sup>-century plaster application.
2. Original first-layer plaster.
3. Line in original first-layer plaster indicates where original baseboard was removed.
4. Replacement baseboard installed over cement-based plaster.

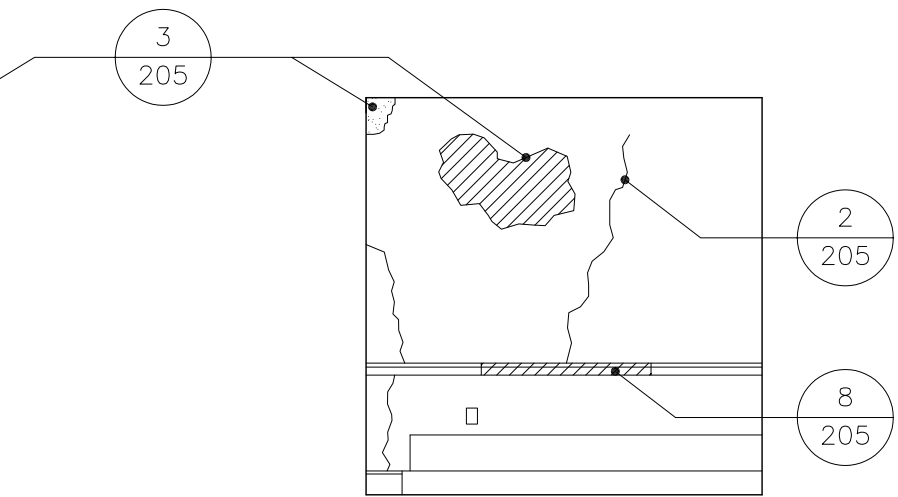




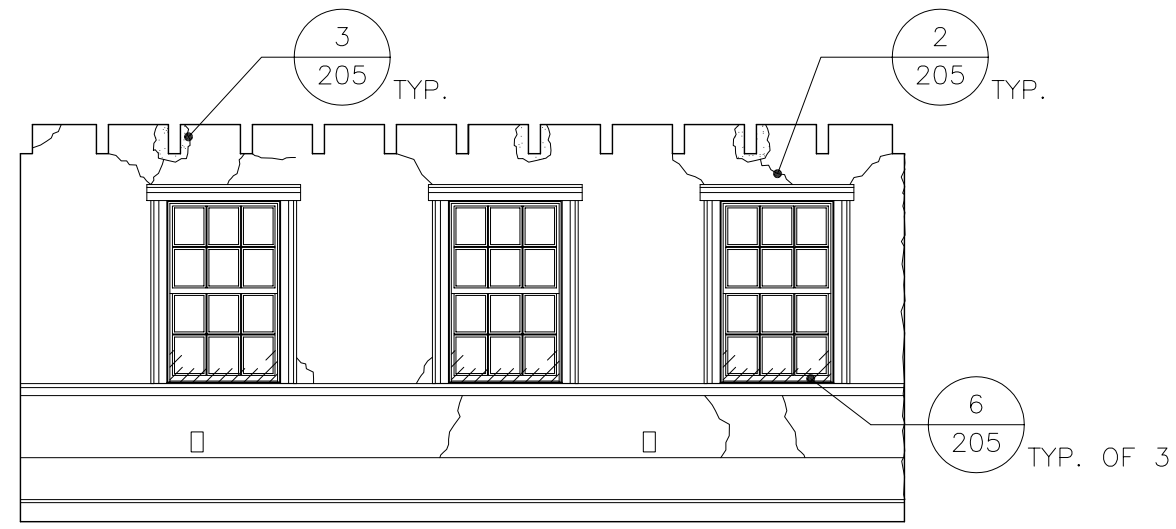
NORTH ELEVATION



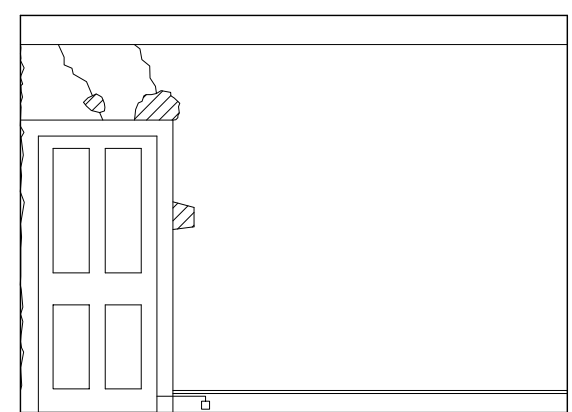
CORNER FIREPLACE ELEVATION



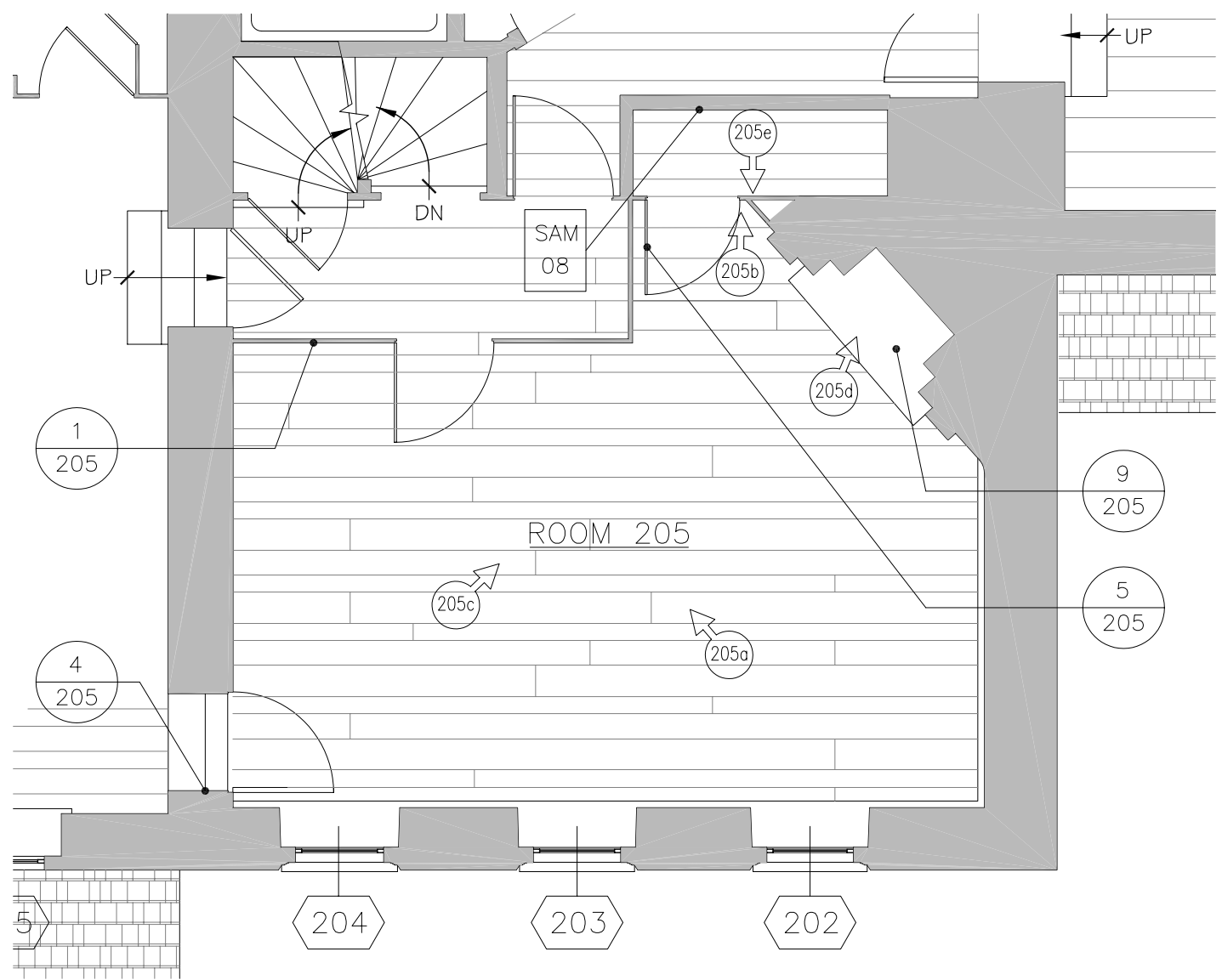
EAST ELEVATION



SOUTH ELEVATION



WEST ELEVATION



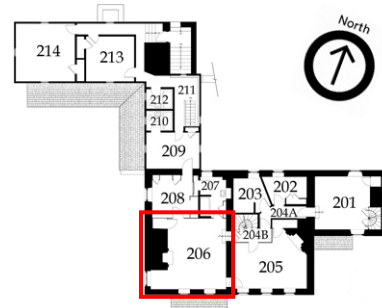
LEGEND:

NUMBER & DIRECTION OF PHOTO 000a  
 REFERENCE NOTE FROM DESCRIPTION NARRATIVE 1 000  
 NUMBER & LOCATION OF MATERIAL SAMPLE SAM 00

N  
 2 0 2 4  
 SCALE OF FEET

### Room 206 -

This room has undergone the most modifications over the life of the house. Beginning as the attic of the original kitchen, then an occupied second-floor loft after the first roof raising to 1½ stories, and remodeled once again when the roof was raised to a full two stories circa 1810.



### Floor

- Random-width floorboards installed in 1926 when the corner winder stair was removed.
- The floor joists between Room 206 and Room 208 appear to have been cut off in-situ. These floor joists originally projected beyond the face of the original north kitchen wall to support the rafter plate and rafters of the original roof of the 1-story kitchen. When the original kitchen was raised to 1½ stories, circa 1790, the roof and cornice were removed, the projecting joists were chiseled back behind the north face of the wall, and new stonework was constructed to elevate the wall by ½ story. The floor joists of Room 208 were inserted next to the existing joists circa 1810 when the kitchen wing was expanded to the north. This detail supports the idea that the original west kitchen wing was first (c. 1790) expanded in height and then later (c. 1810) was expanded to the north and up to the full two stories. (Photo 206d, Figure 206a)

### Walls

- Winder stair tread evidence on south, west and north walls indicates there was a stair to the attic. Winder added c. 1790 when roof was raised to 1½ stories or c. 1810 when larger expansion occurred. (Photo 206c, Note 1/206)
- Vertical line in plaster on south wall corresponds to paint line on ceiling joists and ceiling boards. Line is from a board partition wall which formed a hallway at the winder stair. (Photos 206b & 206c, Note 4/206)
- Plaster removal over a large area of the east wall did not reveal any conclusive evidence of the roof raising chronology.
- Stone mortar on the east wall appears to be finish pointing mortar in some areas and yet in other areas it is sloppy and the ridge is undefined.
- Plaster removal on south wall exposed a possible roof raising “joint” or “line” in the masonry. (Note 5/206)
- The north wall was added after the expansion of the second floor, c. 1810. The present wall is a composite of contemporary 2x4 studs and vertical boards which were installed in the 1920s.
- Large areas of plaster are missing due to architectural investigations.

### Ceiling

- Ceiling joists and undersides of attic floorboards are exposed.
- Plaster line in base plaster layer shows that there was a ceiling when the room was first plastered, probably around 1810.

### Doors

- Plaster removal on the east wall revealed brick in the jambs at the doorway to Room 204 and the closet door. The presence of brick suggests that the doorways were cut into the stone wall after its initial construction. Building chronology also supports this supposition. (Note 2/206)

### Windows

- Double casement window on west wall was added in 1926. Archive photos show a four-light casement window on this wall up until the 1926 renovations. (Note 3/206) (Archive Photos 3 & 7)
- 6/6 single-hung, wood windows on south wall appear to date to c. 1810 when this wing was raised to a full two stories.

### Fireplace

- Fireplace/chimney wall has been furred out. Before circa 1810, there was no fireplace since it was an unoccupied attic. The original (c. 1769) plastered chimney is visible behind the furring. (Photo 206a)



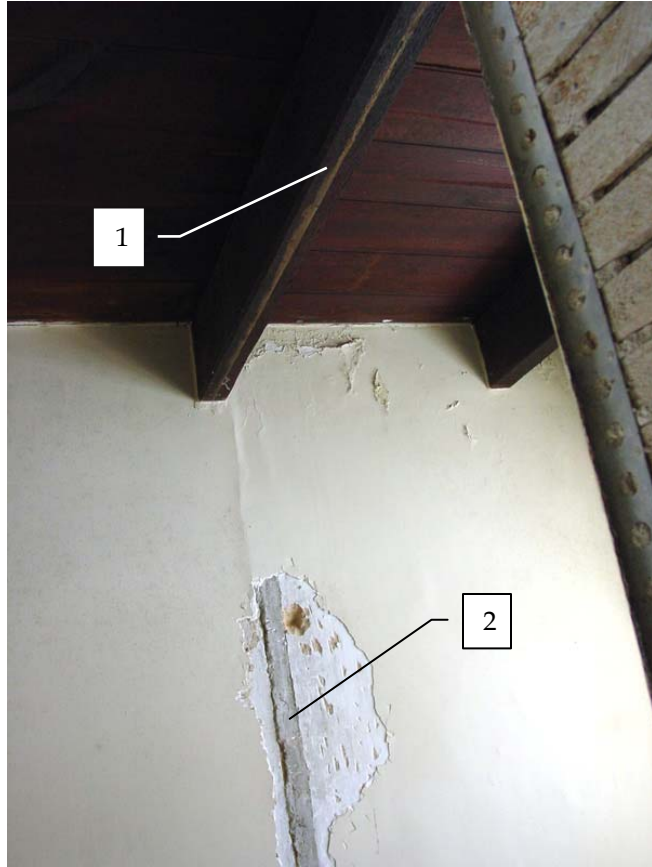
**Photo 206a** – Interior view of Room 206, looking southwest.

1. Fireplace was likely added when the west block was raised to 2 stories, c. 1810. It was later modified as part of the c. 1926 renovations to the house.
2. Wood framing, lath and plaster were added around fireplace and chimney mass subsequent to the original construction of the fireplace, c. 1810. Plastered chimney mass (c. 1769) is visible behind the furring.
3. Evidence in plaster of former winder stair and partition wall. See Photos 206b & 206c for details.

**Photo 206b -**

Detail view of portion of south wall and ceiling, Room 206, looking south.

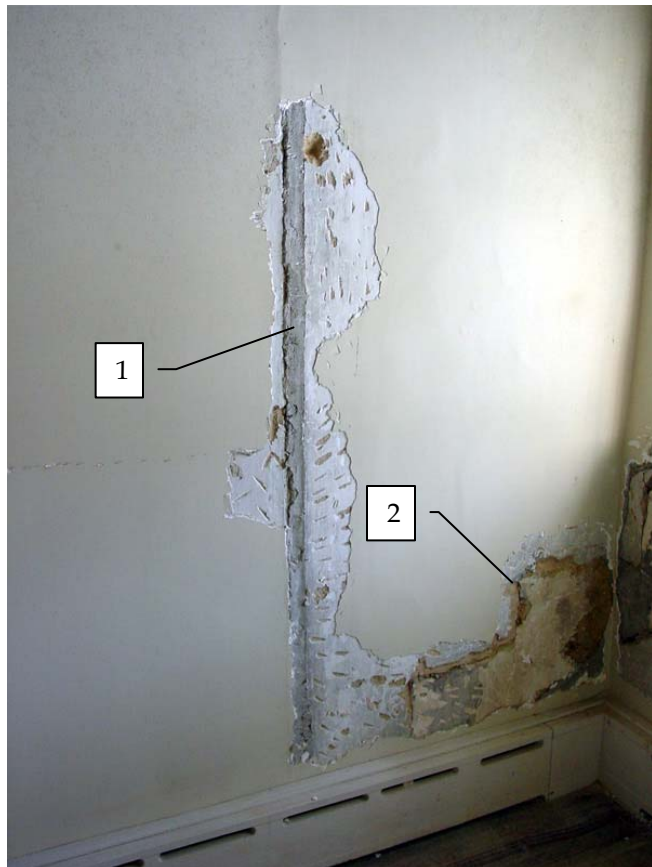
1. Paint line along wood joist.
2. Plaster patch in south wall likely corresponding to former board partition around former winder stair.



**Photo 206c -**

Detail view of portion of south wall, Room 206, looking south.

1. Plaster patch in south wall likely corresponding to former board partition around former winder stair.
2. Evidence in plaster of former winder stair.

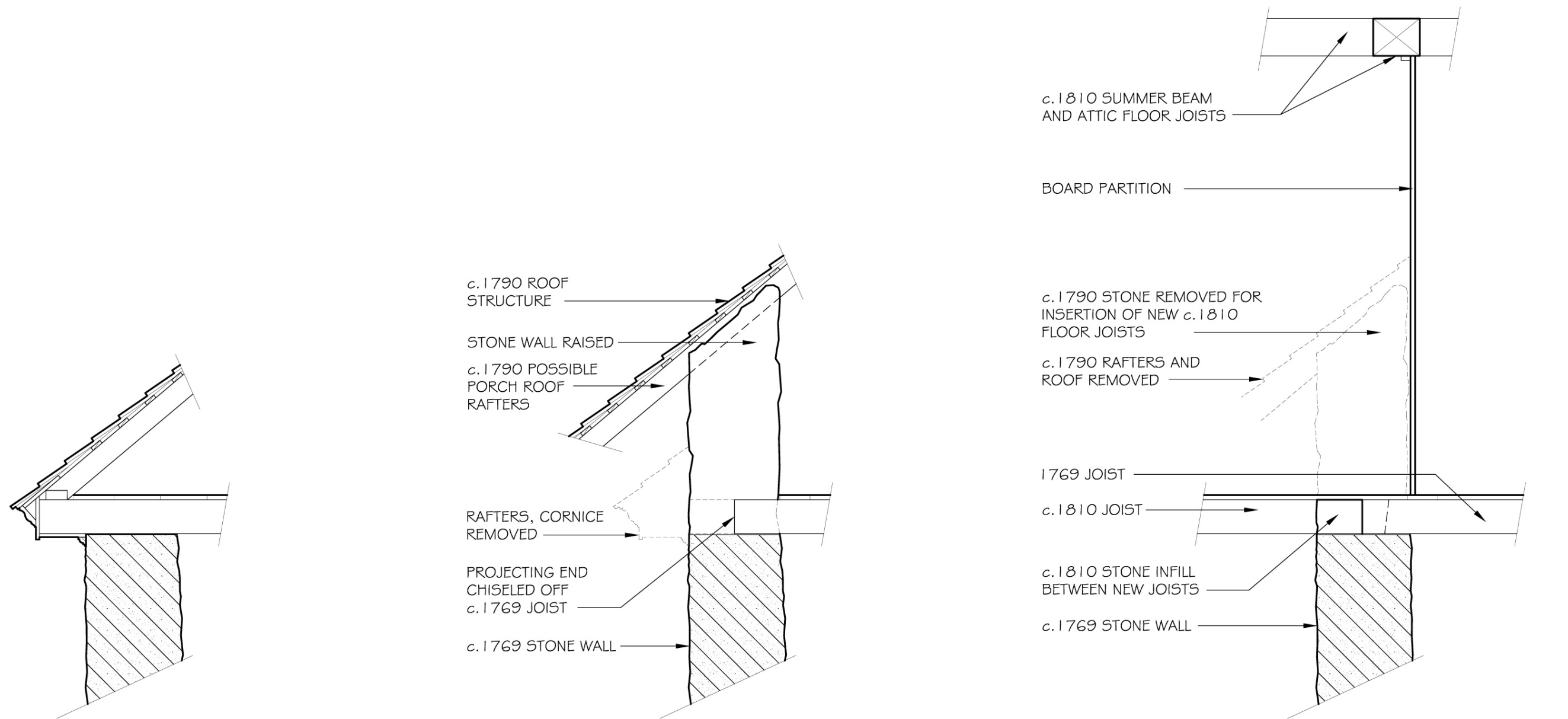






**Photo 206d** – Detail view of floor and framing (over masonry wall), between Room 206 (bottom) & Room 208 (top), looking down.

1. Original joist over c. 1769 kitchen has been chiseled back to accommodate elevation of the walls by  $\frac{1}{2}$  story.
2. Adjacent floor joist for Room 208 added at the time of the c. 1810 expansion to the north.

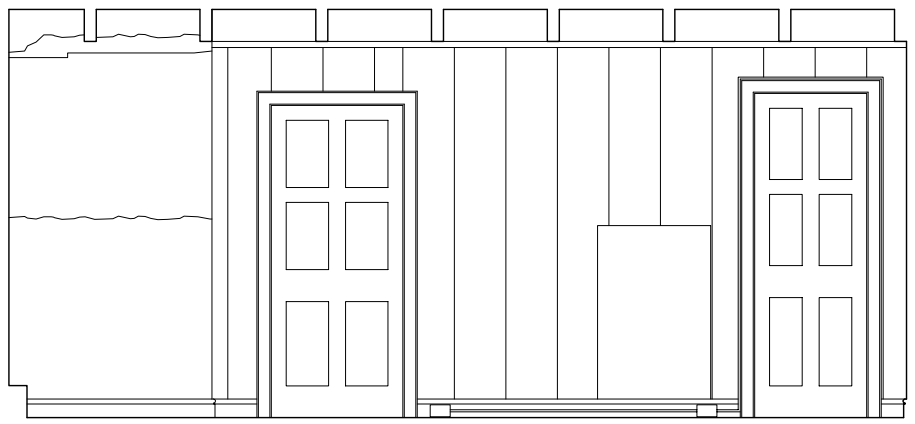


ORIGINAL EAVE CONFIGURATION AT NORTH WALL OF 1-STORY KITCHEN BLOCK, c. 1769

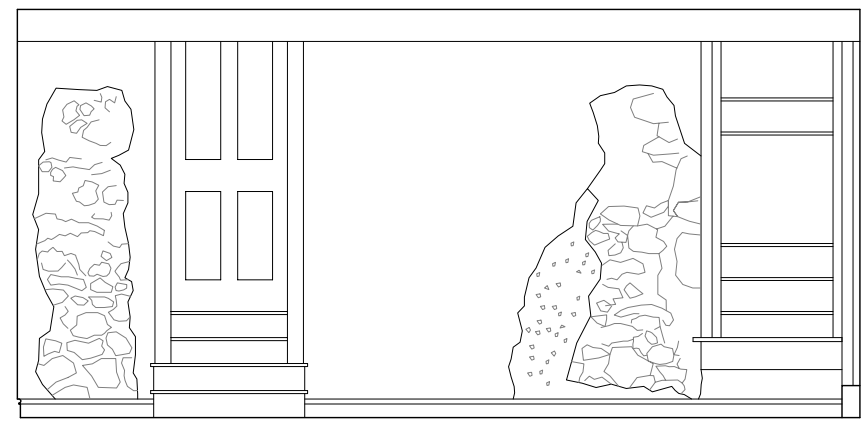
ORIGINAL KITCHEN BLOCK RAISED TO 1½ STORIES, c. 1790

ORIGINAL KITCHEN BLOCK EXPANDED TO NORTH AND RAISED TO 2 STORIES, c. 1810

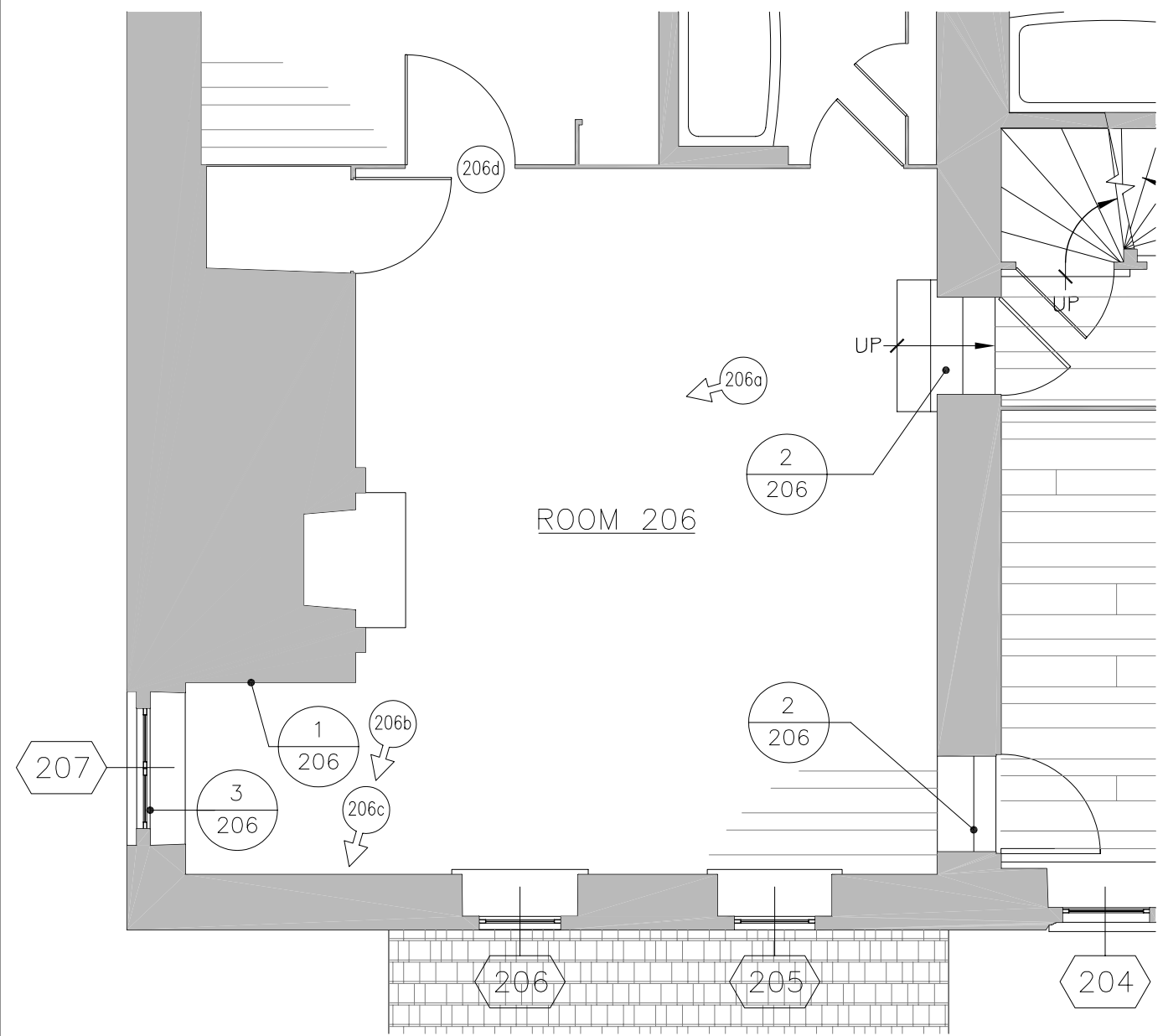
Figure 206a: Details of modifications to north wall of original kitchen block from c. 1769 - c. 1810.



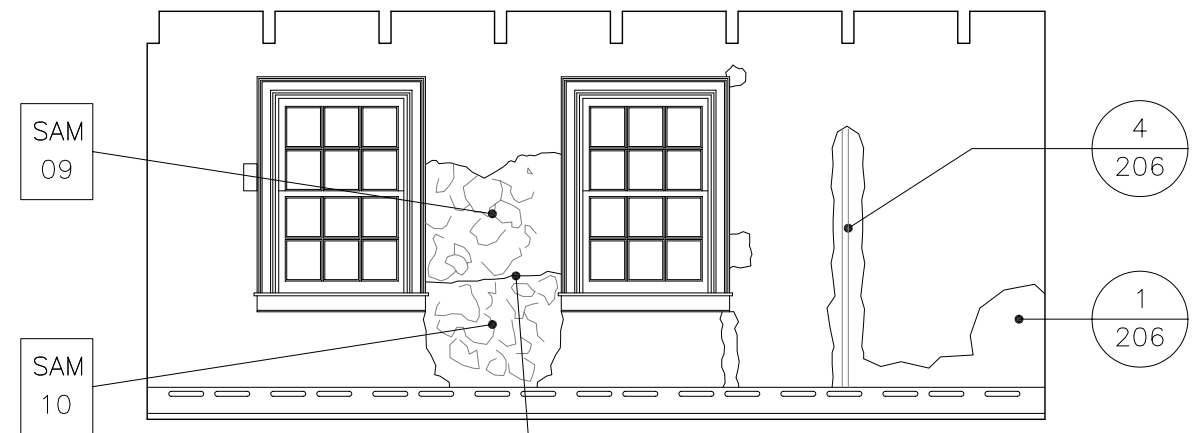
NORTH ELEVATION



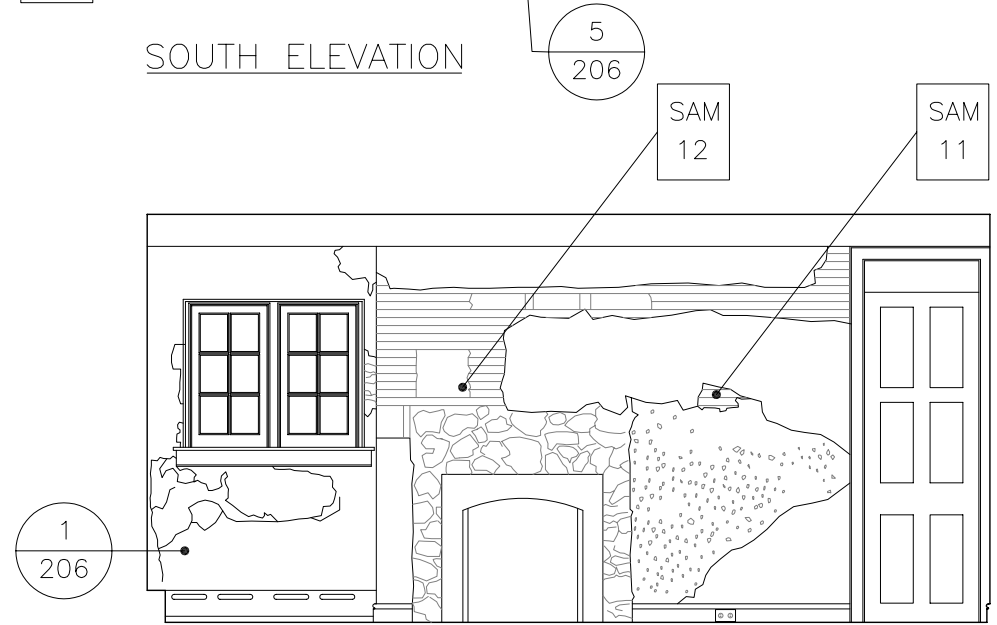
EAST ELEVATION



ROOM 206



SOUTH ELEVATION



WEST ELEVATION

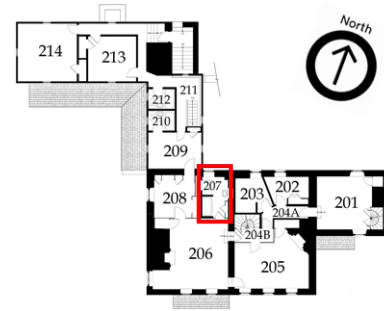
LEGEND:

- NUMBER & DIRECTION OF PHOTO 000a
- REFERENCE NOTE FROM DESCRIPTION NARRATIVE 1 000
- NUMBER & LOCATION OF MATERIAL SAMPLE SAM 00



### Room 207 -

This bathroom was installed in 1926 as part of the Liggett family's extensive renovations. It was remodeled by the National Park Service in the 1970s for use by seasonal employees.



### Floor

- Composite flooring tile has been removed. Mastic still present on top of underlayment.

### Walls

- Removal of the recessed medicine cabinet and plaster above the sink revealed the same doorway seen from Room 203. (Photo 207a, Note 1/207,)
- Closet on east wall is a 20<sup>th</sup>-century addition.
- South wall partition is a 2x4 stud wall with vertical boards. The current wall was installed in the 1920s. There may have been a wall in this location as early as c. 1810 when the building was expanded to its full two-story height. (Note 2/207)
- West wall is largely covered by an existing bathtub and shower surround.
- A plumbing chase was added in the northeast corner.

### Ceiling

- Plaster on sawn wood lath.

### Doors

- South door into Room 206 appears to have been cut in at a later date than the board partition itself. The door has no board header and is detailed differently from the south door of Room 208. (Note 3/207)
- West door to existing closet was originally a door into Room 208. There is baseboard on the door face, but not on any other of the interior closet walls suggesting the later closet addition. (Note 4/207)

### Windows

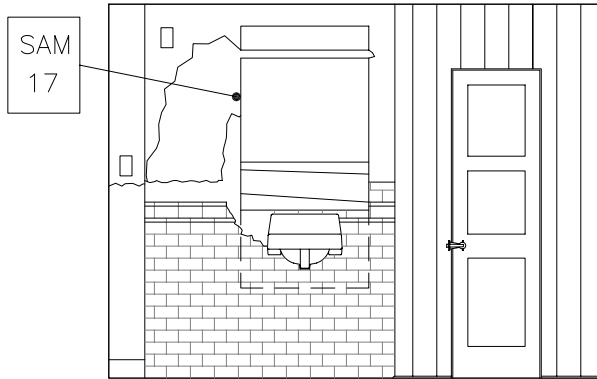
- Window 220: 8/8 single-hung, wood window.



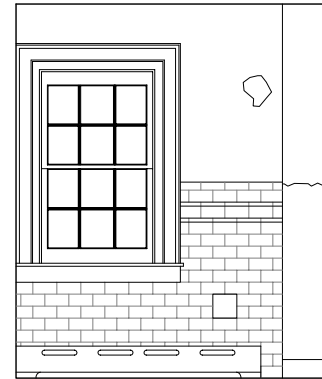


**Photo 207a** – Detail view of north jamb of former doorway between Rooms 203 and 207, looking east.

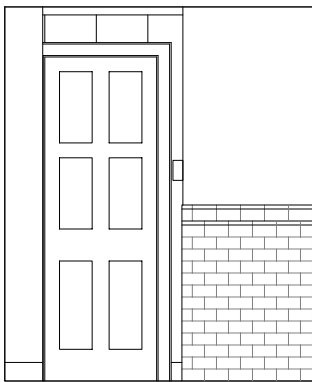
1. 20<sup>th</sup>-century lath and plaster.
2. Line where former door trim abutted plaster.
3. Wood nailer set in masonry to attach door frame.



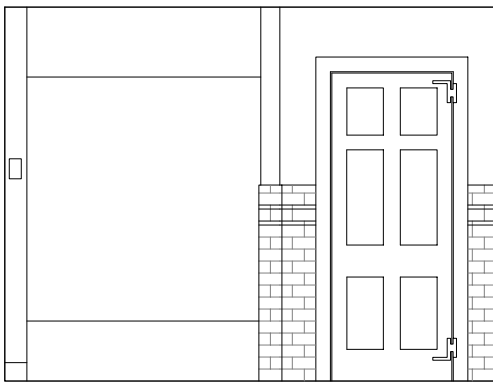
EAST ELEVATION



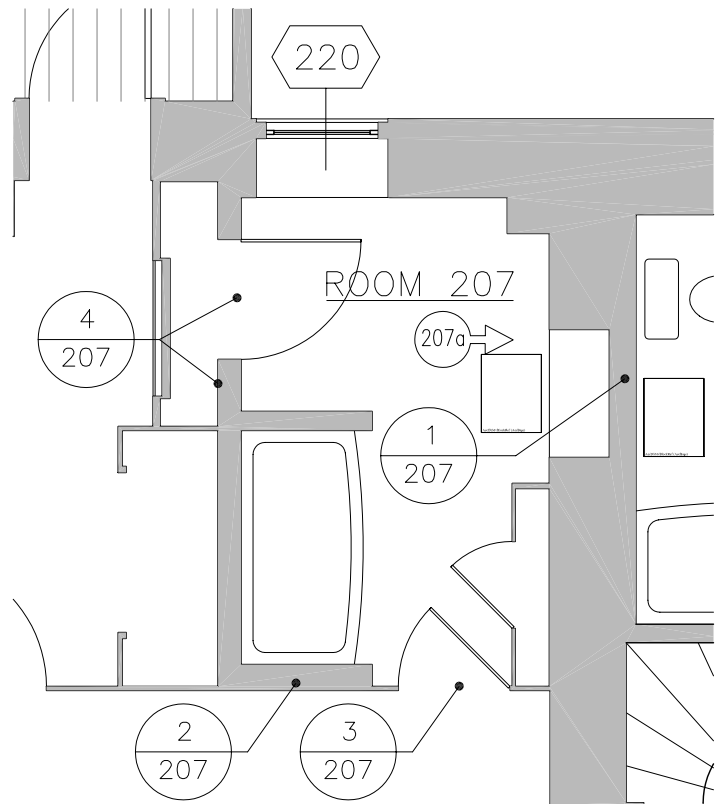
NORTH ELEVATION



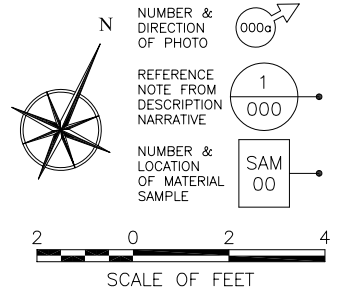
SOUTH ELEVATION



WEST ELEVATION



LEGEND:



Historic Structure Report  
**STIRLING'S QUARTERS**  
 Valley Forge National Historical Park

**JOHN MILNER ARCHITECTS, inc.**

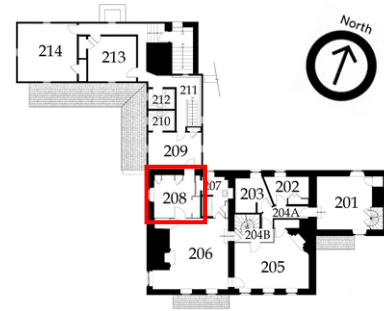
104 Lakeview Drive, Chadds Ford, Pennsylvania 19317 • (610) 388-0111

PHYSICAL  
 DESCRIPTION

ROOM 207

### Room 208 -

Another room that has undergone extensive changes. When originally constructed, the flue from the first-floor cooking fireplace ran up the west wall. Later, the chimney was removed and the window installed by the Ligget family.



### Floor

- Painted random-width wood floorboards.
- Several boards have been removed for electrical and HVAC access and refastened with wire nails.

### Walls

- Cabinetry and closet on north and east walls is 20<sup>th</sup>-century. (Note 1/208)
- Crack in west wall of the room is probably due to the chimney removal in the 20<sup>th</sup> century. (Note 2/208)

### Ceiling

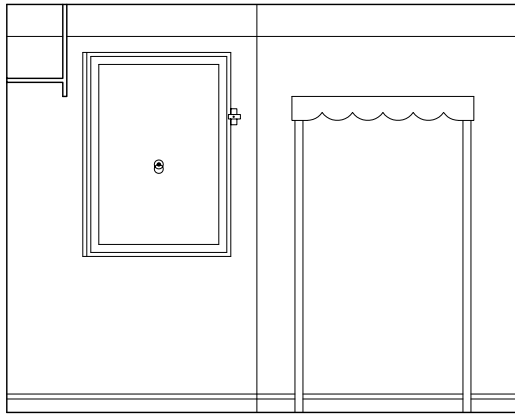
- Ceiling features exposed joists with the underside of the attic floor boards visible.
- Two plugs in the joist adjacent to where the chimney would have been located indicate the header locations.
- The westernmost joist is new and was a replacement for the two partial joists framing around the chimney.

### Doors

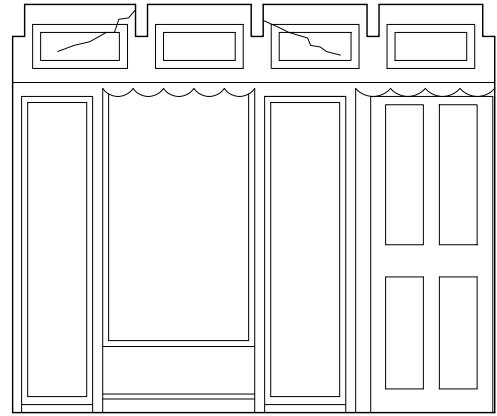
- South door to Room 206 appears original to the board wall. The door header is inset in the board walls. (Note 3/208)
- North door was added in the 20<sup>th</sup> century when the second-floor addition was constructed. (Note 4/208)

### Windows

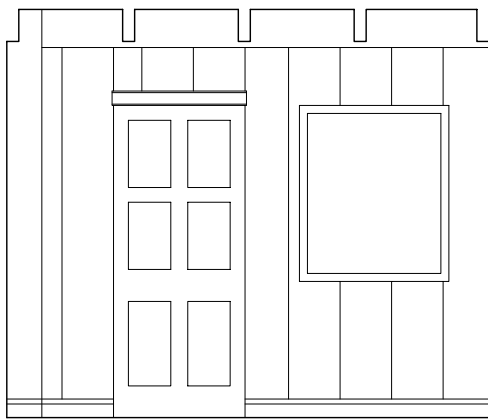
- Window 208: 8/8 single-hung wood window. Window was added in the 20<sup>th</sup> century after the chimney was removed. (Note 5/208)



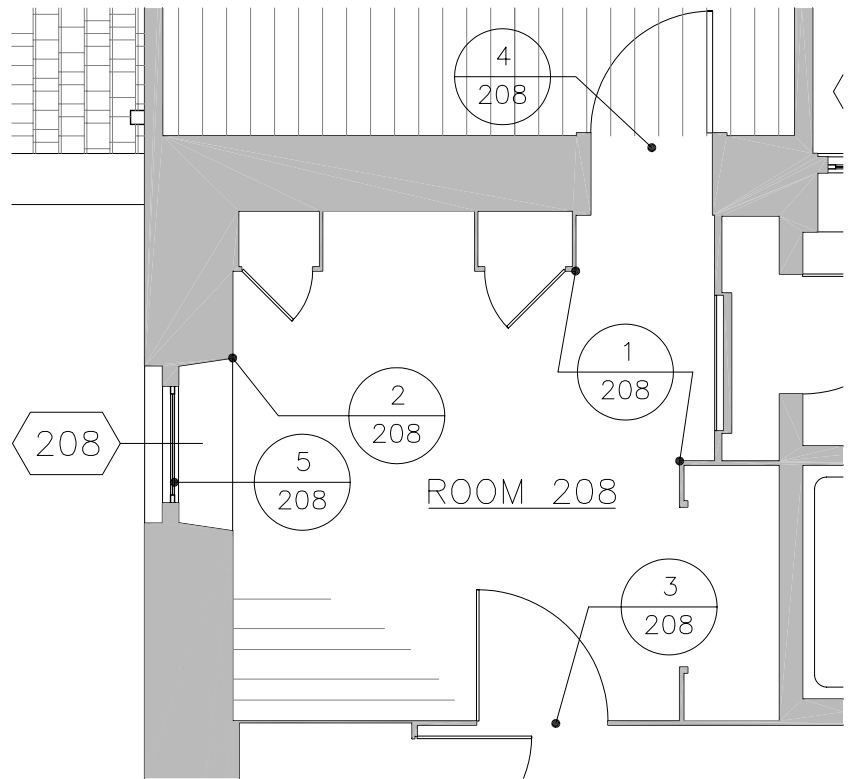
EAST ELEVATION



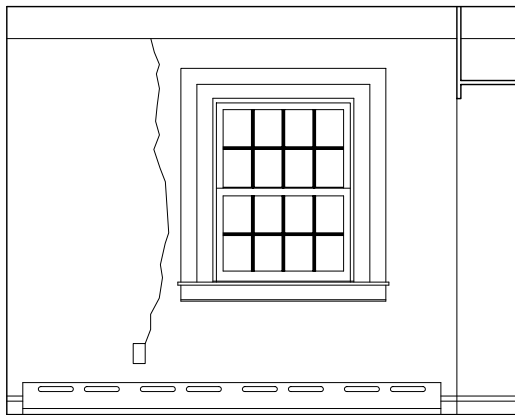
NORTH ELEVATION



SOUTH ELEVATION






ROOM 208



WEST ELEVATION

LEGEND:

NUMBER & DIRECTION OF PHOTO  (000a)  
 REFERENCE NOTE FROM DESCRIPTION NARRATIVE  1  
 NUMBER & LOCATION OF MATERIAL SAMPLE  SAM 00



Historic Structure Report  
**STIRLING'S QUARTERS**  
 Valley Forge National Historical Park

**JOHN MILNER ARCHITECTS, inc.**

104 Lakeview Drive, Chadds Ford, Pennsylvania 19317 • (610) 388-0111

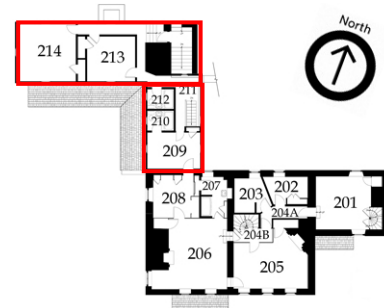
PHYSICAL  
 DESCRIPTION

ROOM 208



### Rooms 209-214 -

All the rooms to the north of Room 208 were added by the Liggett family circa 1926. The preliminary architectural drawings delineated by Boyle Irwin in 1926 refer to these rooms as servants' quarters.



### Floor

- Wood floorboards are generally in good condition.

### Walls

- Plaster on sawn wood lath is generally in good condition.
- Plaster applied directly to the south masonry wall in Room 209 and chimney in Room 211. Chimney plaster is deteriorated due to roof leaks.

### Ceiling

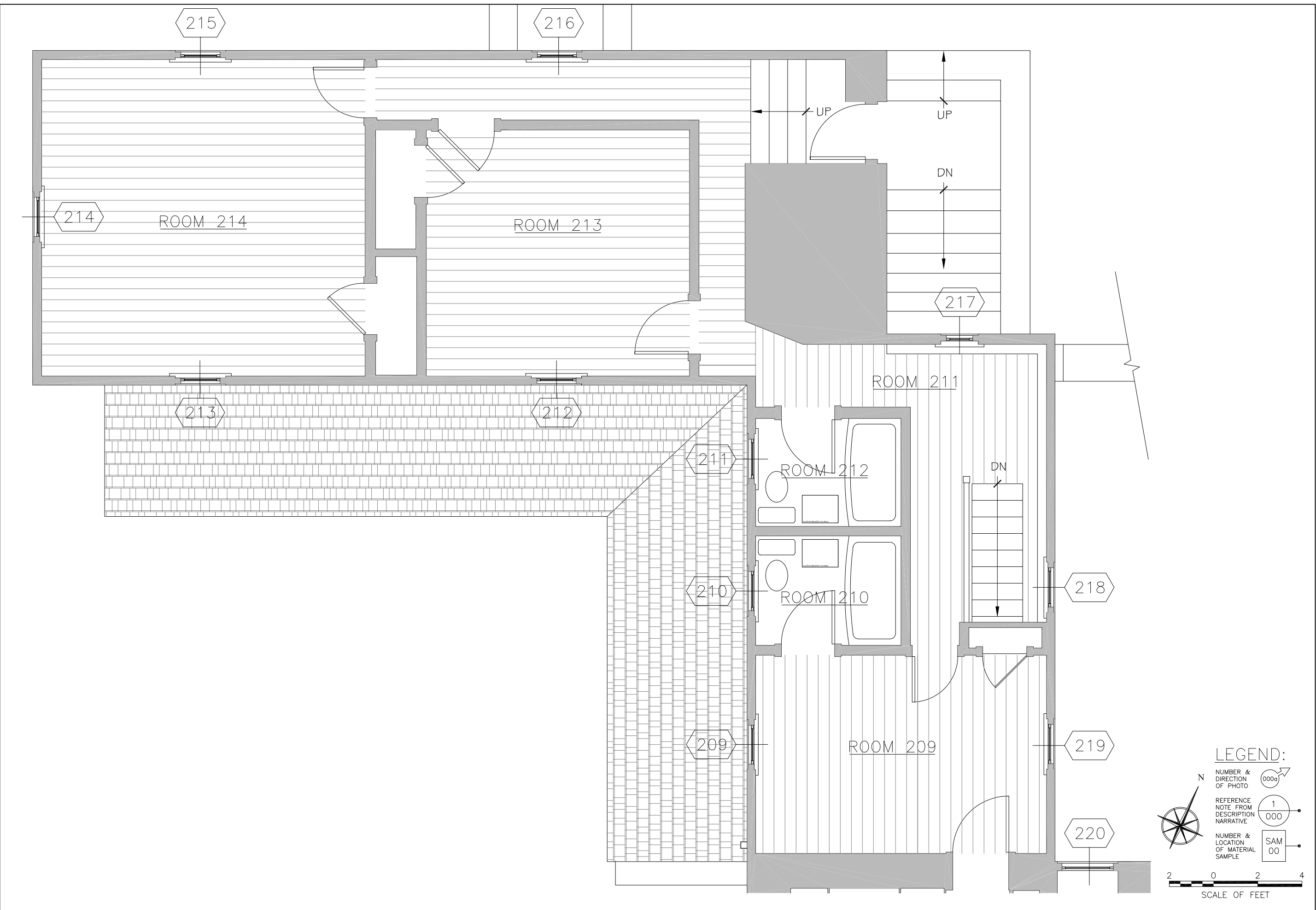
- Plaster on sawn wood lath is generally in good condition.

### Doors




- Existing doors date to the c. 1926 renovation of the building. Doors are in generally moderate condition.



### Windows

- Typical windows are 6/6 double-hung wood units installed c. 1926.



**LEGEND:**

NUMBER & DIRECTION OF PHOTO  000a  
 REFERENCE NOTE FROM DESCRIPTION NARRATIVE  1 000  
 NUMBER & LOCATION OF MATERIAL SAMPLE  SAM 00

  
 SCALE OF FEET  


Copyright 2005 John Milner Architects, Inc.

Historic Structure Report

**STIRLING'S QUARTERS**  
Valley Forge National Historical Park

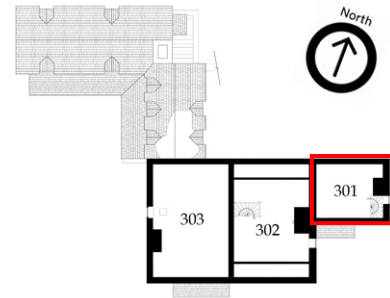
**JOHN MILNER ARCHITECTS, inc.**  
104 Lakeview Drive, Chadds Ford, Pennsylvania 19317 • (610) 388-0111

PHYSICAL DESCRIPTION

ROOMS  
209-214

### Room 301 -

This attic or garret was constructed as part of the c. 1830 east addition.



### Floor

- Attic floor is comprised of two layers of floorboards. The top layer is a mixture of beaded, tongue and groove, and butt edge boards. Based on the wire nails observed in the top layer, it appears that the floor was added in the 20<sup>th</sup> century to cover deteriorating original boards (left in situ) or to cover board gaps that allowed air infiltration.

### Walls

- West wall is coated with rough textured stucco. This was originally the exposed east façade of the main block.
- The lower corner of an original main block attic window is visible just under the rafters at the west wall. (Note 3/301)

### Rafters

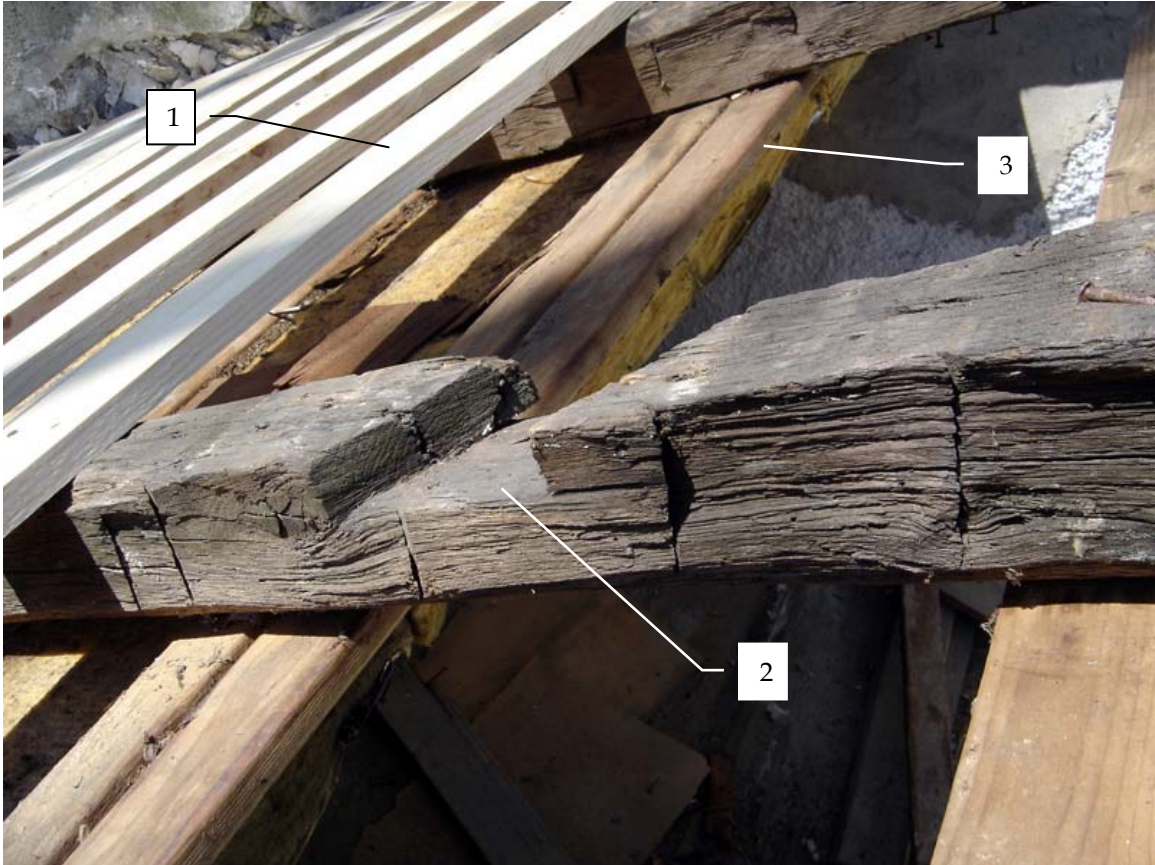
- Recent framing reinforcements are evident in the rafter framing.
- Many of the rafters have been reused from other locations. Several rafters are cut for half-lap collar tie connections, but there is no corresponding connection on the opposite rafter. Several other rafters are cut on top which has no correlation to existing conditions. (Photo 301a)

### Stair

- Winder stair from Room 201 is original to this wing with the treads plastered in place. (Note 1/301)

### Windows

- Window 301: Four-light window sash in very poor and deteriorated condition. The wall plaster abuts this frame indicating that the frame is original. (Note 2/301)



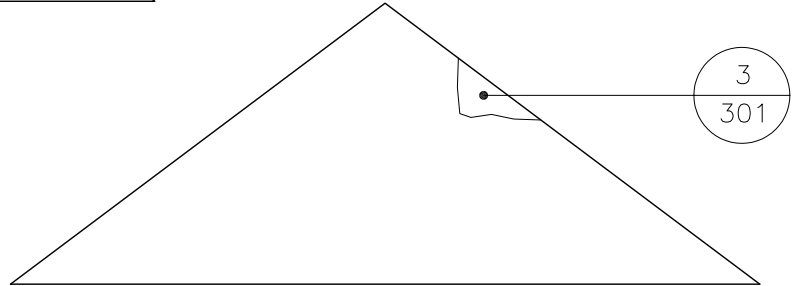
**Photo 301a** – Detail of east roof rafter. Note: Shingles were removed at the time this photograph was taken.

1. Lath for replacement shingle roof.
2. Reused roof rafter with notch for half-lap joint from former use.
3. Lath at underside of roof used to hold insulation in place. Date of installation is unknown.

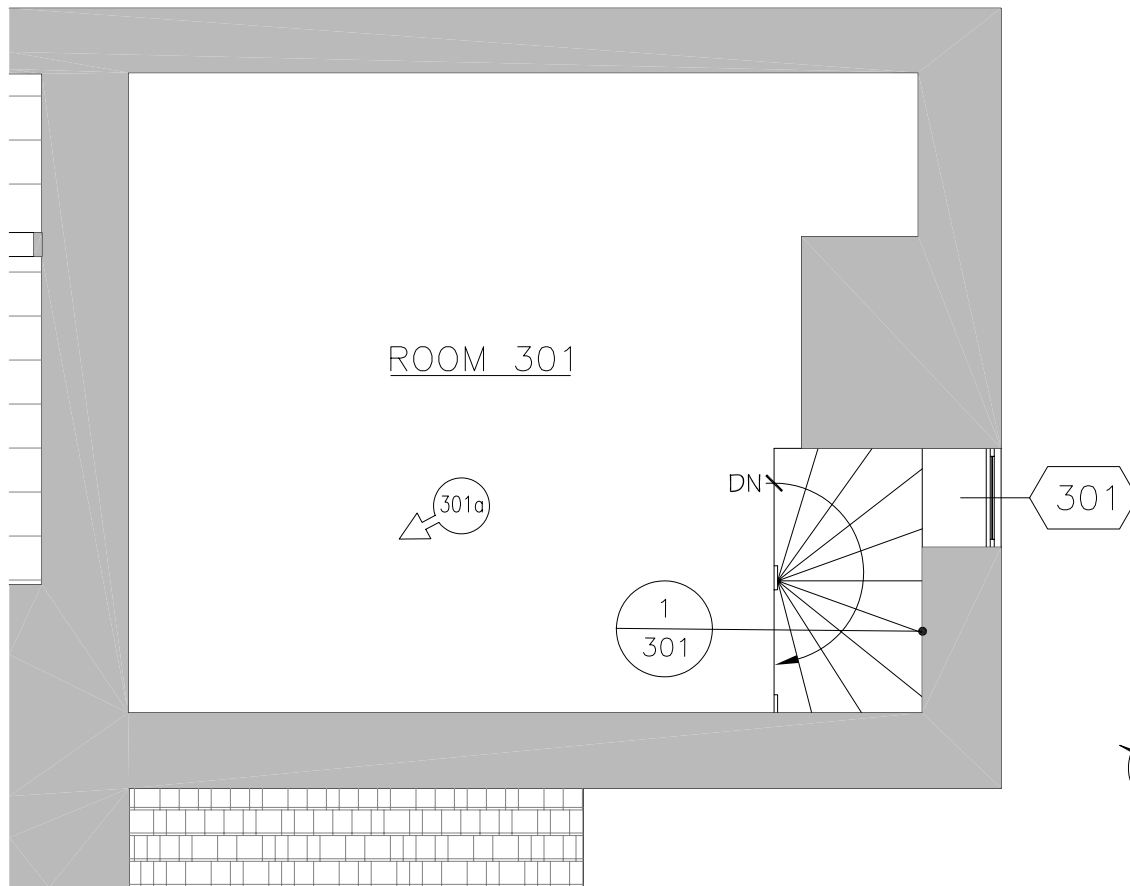







EAST ELEVATION

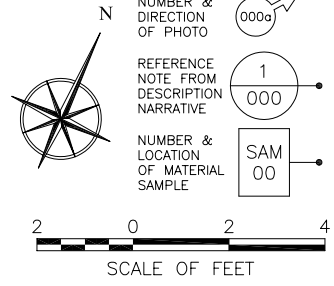


WEST ELEVATION



LEGEND:

NUMBER & DIRECTION OF PHOTO  000a  
 REFERENCE NOTE FROM DESCRIPTION NARRATIVE  1 000  
 NUMBER & LOCATION OF MATERIAL SAMPLE  SAM 00



SCALE OF FEET

Historic Structure Report  
**STIRLING'S QUARTERS**  
 Valley Forge National Historical Park

**JOHN MILNER ARCHITECTS, inc.**

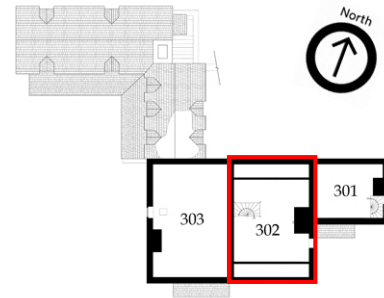
104 Lakeview Drive, Chadds Ford, Pennsylvania 19317 • (610) 388-0111

PHYSICAL  
 DESCRIPTION

ROOM 301

### Room 302 -

Room 302 represents the original attic space over the main block of the house.



#### Floor

- Consistent-width floorboards are in acceptable condition, secured with cut flooring nails. The floorboards are thought to date to c. 1926.

#### Stair

- Winder stair is original to the construction of the c. 1769 main block. Floor framing for stair opening has not been altered. Rosehead nails were found in treads and risers. (Note 1/302)
- Tongue and groove boards, beaded on both sides, enclose the original winder stair. (Note 2/302)
- Railing appears original and is intact. Flooring (added c. 1926) is cut around railing posts.

#### Windows

- The east wall originally had two (2) four-light windows flanking the chimney. The north window has been removed though the plastered recess and lintel remain. The opening was blocked in by the c. 1830 east addition. (Photo 302b, Note 3/302)
- Window 302: There are indentations in the frame of the east wall window indicating the possibility of louver slats instead of glazed sashes. However, if this is the case, this would contradict the Glass Tax (i.e., the 1798 U. S. Direct Tax) which indicated two (2) four-light windows on the original main dwelling unit. (Photo 302a, Note 4/302)

#### Framing

- Recent structural modifications have introduced 2x6 knee walls and a large steel ridge beam with steel support post.
- Rafter plate angled and penetrates gable wall on east end only.
- Joists are cut flush with exterior wall which may be due to deterioration.



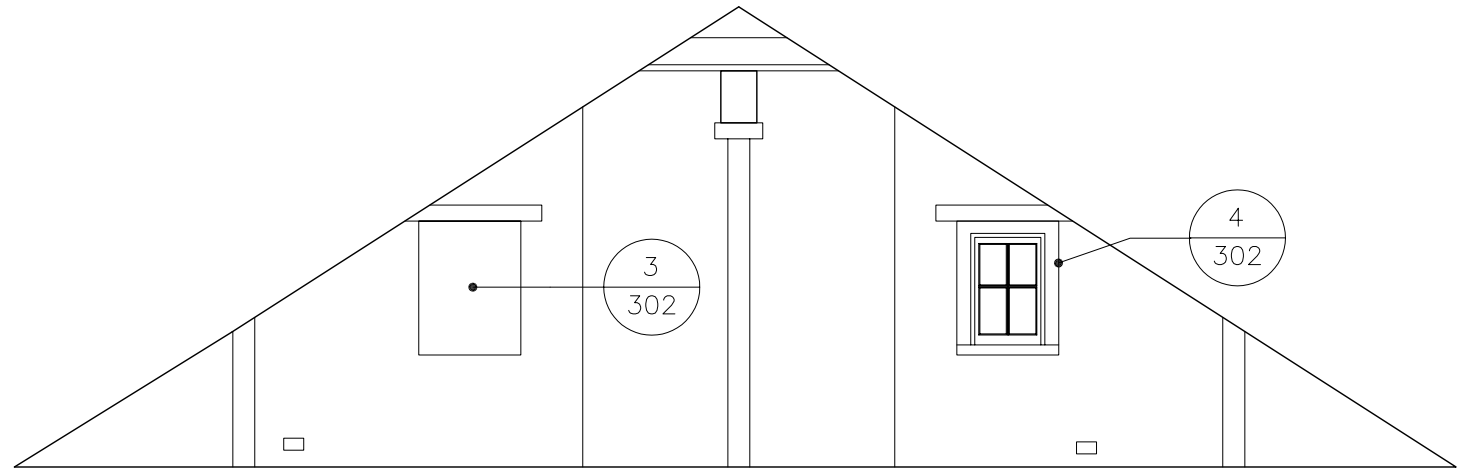
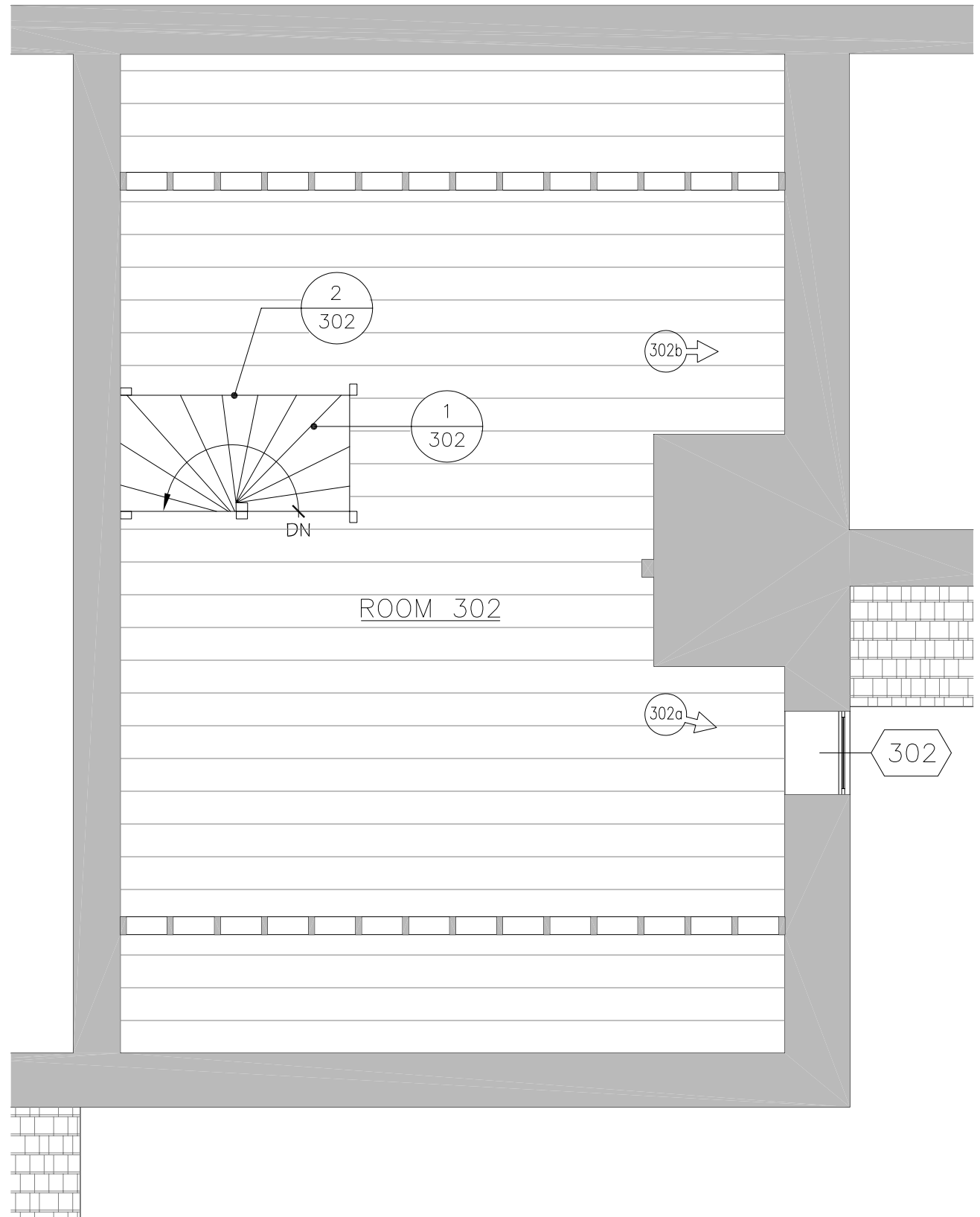
**Photo 302a** – Interior view of Window 302, looking southeast.

1. Indentations in wood jamb indicate the window opening formerly featured louver slats instead of glazed sashes.

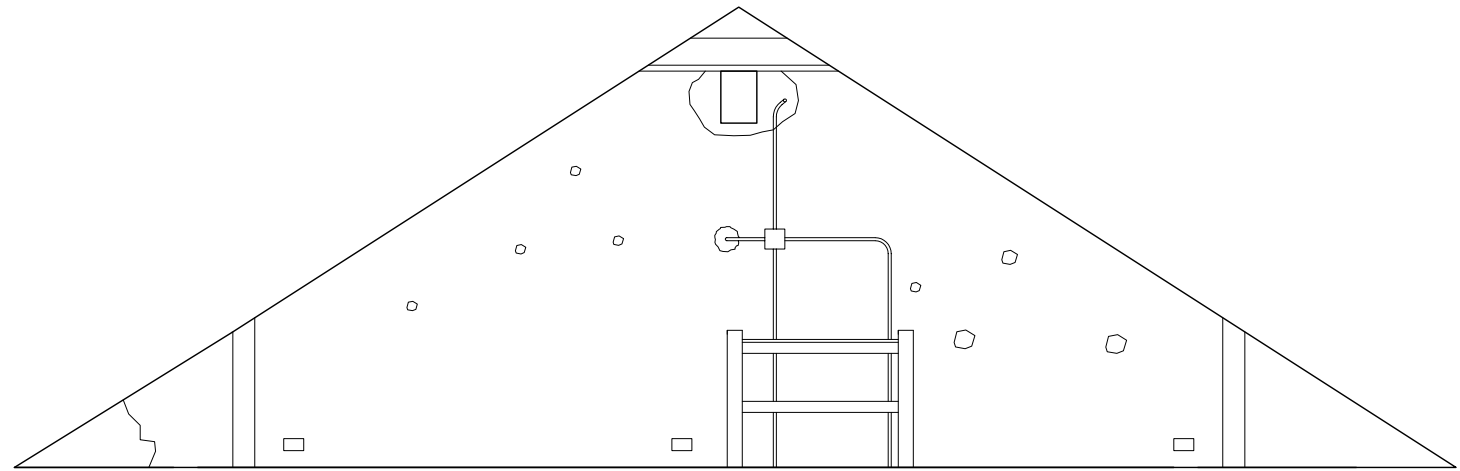


**Photo 302b** - Interior view of former window opening at east wall, north side of chimney, Room 302, looking east. Opening was in-filled c. 1830 during construction of the east addition.







EAST ELEVATION





WEST ELEVATION


**LEGEND:**

NUMBER & DIRECTION OF PHOTO 

REFERENCE NOTE FROM DESCRIPTION NARRATIVE 

NUMBER & LOCATION OF MATERIAL SAMPLE 

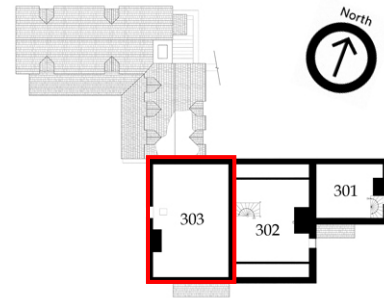




SCALE OF FEET

### Room 303 -

This attic space resulted from the building campaign which expanded the house to the north of, and above, the original kitchen circa 1810. The space appears to have been a finished living space at one time.



### Floor

- The attic flooring is random width floorboards that have been damaged by roof leaks.
- Access to the attic is currently through an access hatch in the northwest corner. (Note 1/303)
- Originally there was a winder stair in the southwest corner. Evidence of the winder treads is present in the room below and the floorboards in this area are different from the other floorboards throughout the attic. (Note 2/303)

### Walls

- East and west gable stone walls have been plastered. The plaster is in poor condition, particularly on the west wall where chimney and roof leaks have saturated and severely damaged the finish.
- There is a gray cement patch on the west wall corresponding to the angled window that existed before the roof line was lowered. The story behind this window is unclear. (Note 3/303)
- On the west wall, beneath the plaster on the chimney mass, is a rough stone peak corresponding to the peaked ledge at the exterior. In addition, a very small piece of sloped mortar is present on the chimney which appears to be a remnant of mortar "flashing" from the earlier, 1½-story roof line (c. 1790). (Photos 303b & 303c, Note 4/303)
- Further north on the west wall is a crack and disturbed stone from the removal of the c. 1810 chimney. The chimney was removed in 1926. (Photo 303a, Note 7/303)
- The plaster on the east wall extends above the current collar ties. (Note 5/303)
- There is a vertical mark in the plaster on the east wall from a board partition, further supporting the idea that the space was finished living space at one time. (Note 6/303)

### Ceiling/Roof

- The roof framing is not original (see Structural Evaluation). A 1902 photo shows that the roof height was originally the same as the main block. The Liggets lowered the roof during their renovations of the building c. 1926. (Archive Photos 3 & 6)
- Plaster on the east wall runs above the existing collar ties to a straight horizontal line. This line was probably the underside of the collar ties of the higher roof. Without the earlier collar ties, it is difficult to tell if the ceiling was plastered, but there is a slight curve at the top of the plaster which suggests a plaster ceiling. (Note 6/303)

### Windows

- Window 303: six-light wood sash window set in a modified wood frame. Archive photos of the west gable show that this opening was previously a 6/6 window before the roof was lowered. (Archive Photos 3 & 7)
- The six-light window surround is also patched with gray cement which is likely related to the roof lowering and the changing of the 6/6 window.



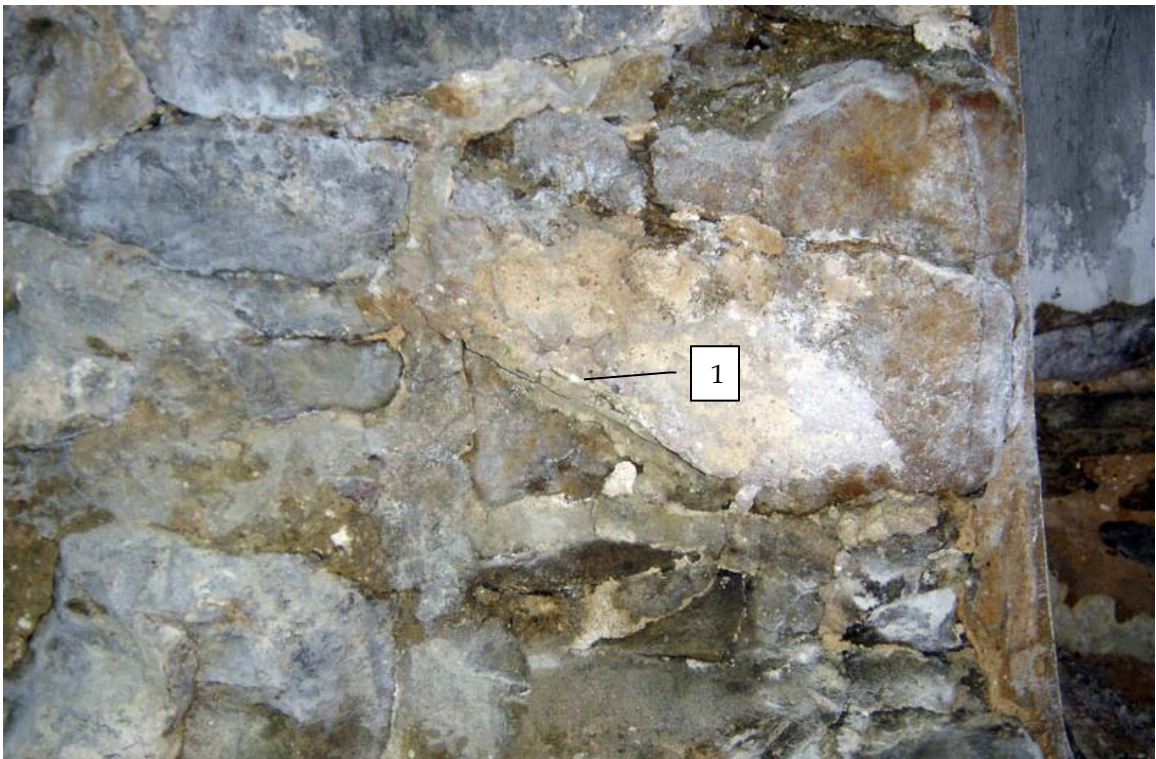
**Photo 303a** – West wall, north end, Room 303, looking west.

1. Masonry crack and disturbance in masonry where former chimney was removed c. 1926.



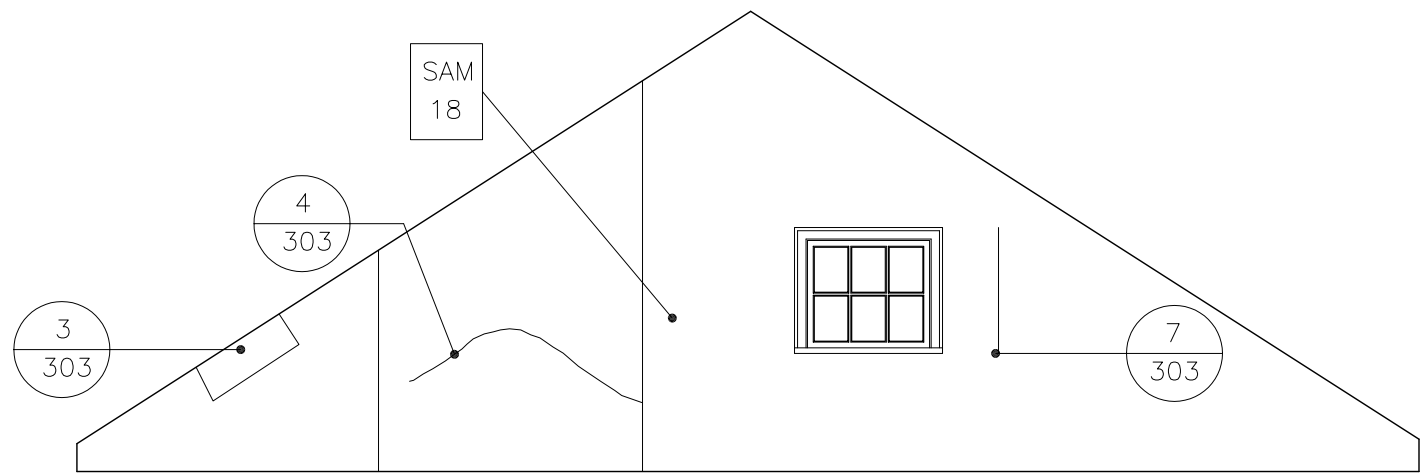
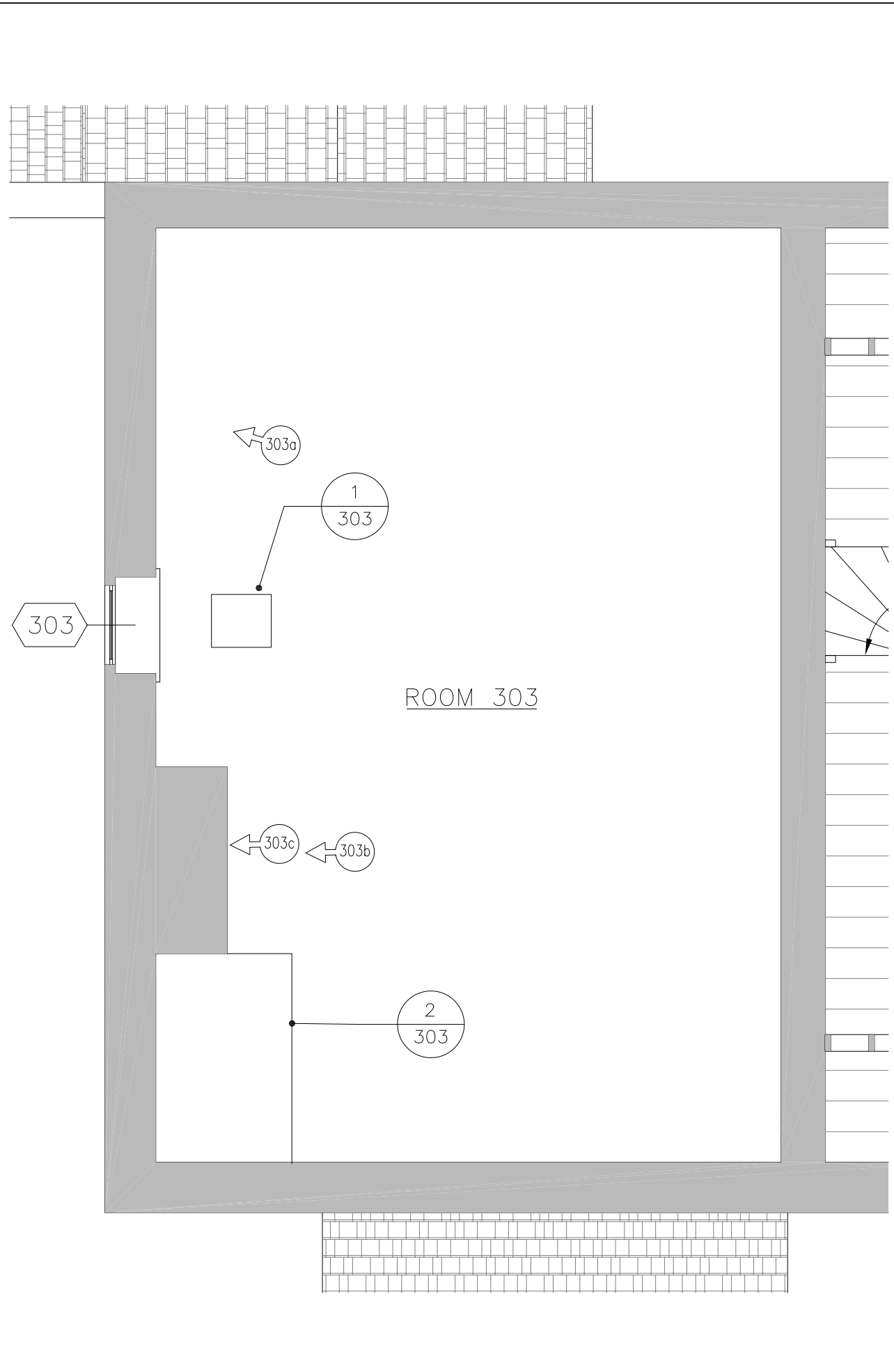


**Photo 303b** - Chimney mass at west wall, Room 303, looking west. Outline indicates masonry peak corresponding to the peaked ledge at the exterior west elevation of the building.

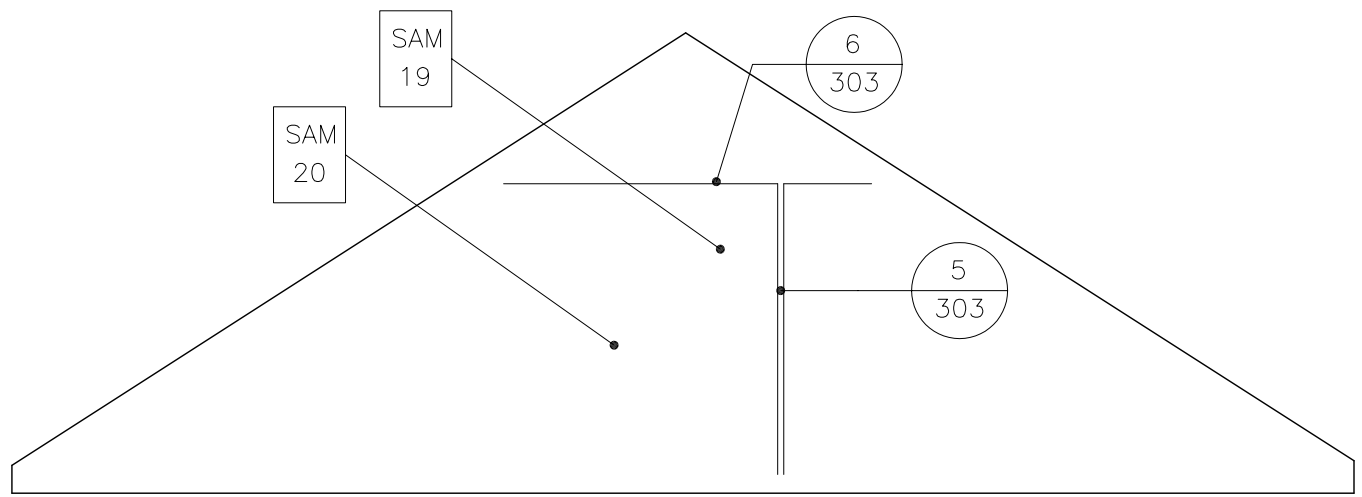


**Photo 303c** - Detail view of north half of chimney mass at west wall, Room 303, looking west.  
1. Remnant of mortar "flashing" from previous c. 1790 roof location.





WEST ELEVATION



EAST ELEVATION

**LEGEND:**

N  
 NUMBER & DIRECTION OF PHOTO 000a  
 REFERENCE NOTE FROM DESCRIPTION NARRATIVE 1/000  
 NUMBER & LOCATION OF MATERIAL SAMPLE SAM 00

SCALE OF FEET

## 1.4 STRUCTURAL EVALUATION



## 1.4 STRUCTURAL EVALUATION

An evaluation of the building's structural systems (floor framing, roof framing, etc.) was conducted by Gary Gredell, P.E. of Gredell & Associates to determine the condition of the component structural members and to identify remedial work required to ensure continued structural stability. The structural evaluation consisted primarily of visual observations combined with selective probing of various portions of the building's structural framework which were safely accessible without the use of staging or uncovering.

The structural engineering assessment was prepared by the Structural Engineer in the form of letter reports stating the findings and offering recommended courses of action to correct observed deficiencies. The assessments and recommendations listed below have been excerpted and summarized from the full reports included as Appendix D.



### General Description

The building was originally designed and constructed as a residential structure. It is comprised of four distinct blocks. The main block, constructed circa 1769, is a three-bay, double pile, 2½-story stone masonry residence constructed over a full basement. To the west of the main block is the original kitchen, constructed with the main block in 1769, and an addition to the north of the kitchen built circa 1810. The western stone masonry gable end wall of the original kitchen block was also expanded vertically to accommodate the northwest addition. Located on the east side of the main block is a two-story, single pile addition constructed over a full basement. In 1926, a 2-story stone masonry and wood frame addition was introduced at the north end of the c. 1810 kitchen extending over the existing springhouse/bakehouse. The engineer's sketches (Figures S-1 thru S-7) provide the plan form of the building as described above and the framing that was observed.

### Allowable Live Load Capacity

In the process of rehabilitation, the building must be made structurally sound and the strength of the floor framing must be adequate to support at least the minimum live load requirements imposed by good practice and the building code for the intended use.<sup>60</sup> The following table provides a summary of the minimum uniformly distributed floor loading for various uses recommended by the building code:

<u>Occupancy or use</u>	<u>Live load (PSF)</u>
Residences	
First floor	40
Second floor and habitable attics	30
Uninhabitable attics	20
Offices	50

In addition to the framing configurations, the engineer's sketches of the framing plans (Figures S-1 thru S-7) include the allowable uniformly distributed live loading for each level with regard to both strength and stiffness of the framing members.<sup>61</sup> For strength it was assumed that the original building material meets the current requirements for "select structural" with an allowable extreme fiber bending stress and elastic modulus of 2000 PSI and 1,600,000 PSI, respectively. For the reframed roofs, the hem-fir No. 2 lumber has an allowable bending stress of approximately 875 PSI. The "stiffness" criteria (indicated by the graphic delta) that is provided applies to framing with attached plaster finishes. This includes the second- and attic-floor framing only, since neither basements nor attic spaces are finished. Based on good practice, the allowable live load deflection of the framing that supports plaster is limited to 1/360 of the span. Greater deflection or "bounce" in the floors tends to reduce the service life of the plaster finishes.

---

<sup>60</sup> International Building Code 2000.

<sup>61</sup> Strength is defined as the ability of a structural member to resist live load. Stiffness refers to the dimensional stability of a structural component under elastic stresses. Stiffness depends on the component's geometry and its modulus of elasticity which is the ratio of force applied (stress) to the corresponding deformation (strain).



**GREDELL  
& ASSOCIATES**  
 STRUCTURAL ENGINEERS

5700 KIRKWOOD HIGHWAY • SUITE 206 • WILMINGTON, DELAWARE 19808 • 302-996-9500

PROJECT Stirling  
 NO. 554132 SHEET 1 OF 4  
 CALCULATED BY me DATE 5 Feb 05  
 CHECKED BY \_\_\_\_\_ DATE \_\_\_\_\_

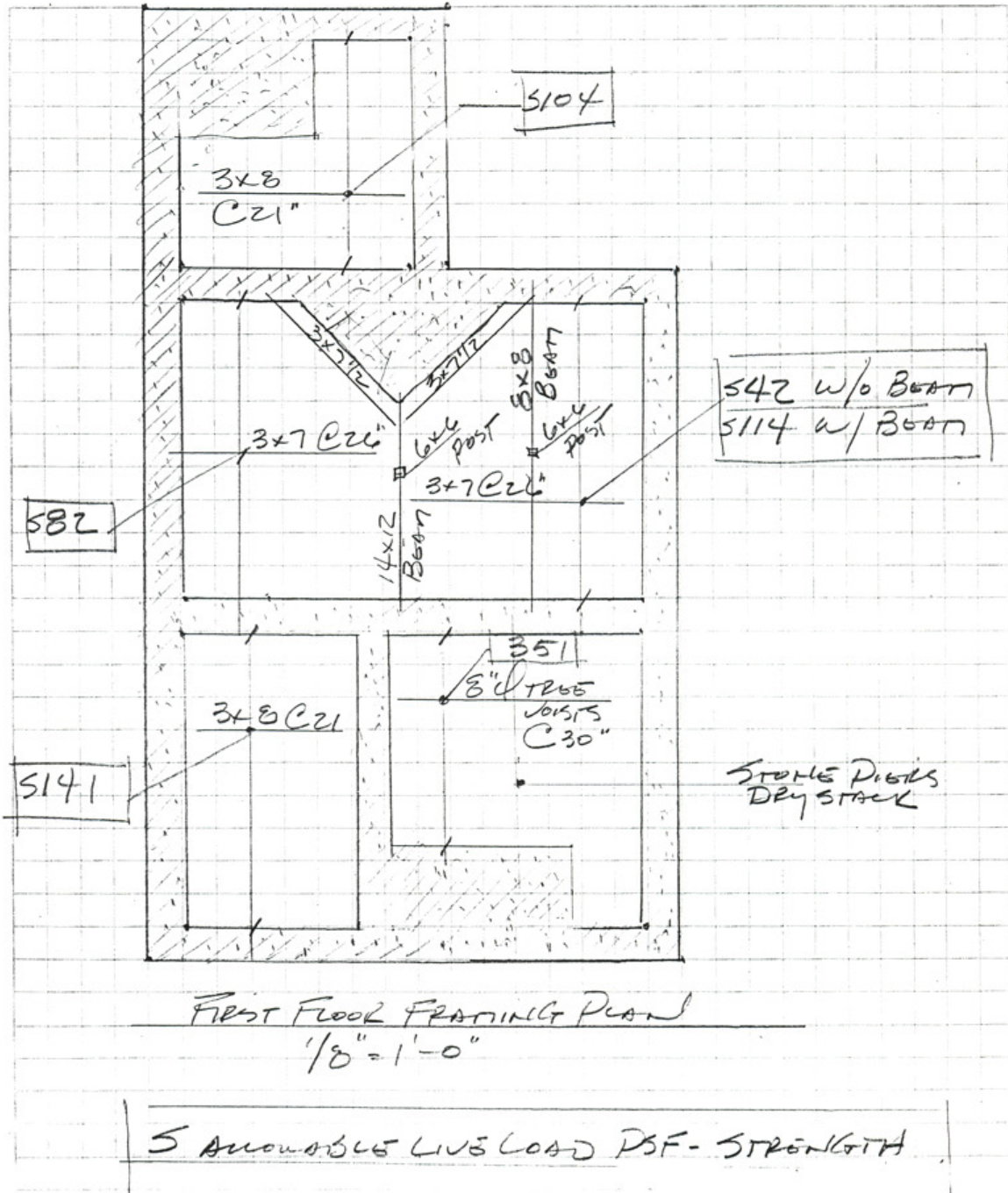


Figure S-1: Sketch of First Floor Framing Plan. (Note: Image is not to scale).

**GREDELL  
& ASSOCIATES**  
 STRUCTURAL ENGINEERS

5700 KIRKWOOD HIGHWAY • SUITE 206 • WILMINGTON, DELAWARE 19808 • 302-996-9500

PROJECT Stirling  
 NO. 554.132 SHEET 2 OF 4  
 CALCULATED BY Qu DATE 5 Feb 06  
 CHECKED BY \_\_\_\_\_ DATE \_\_\_\_\_

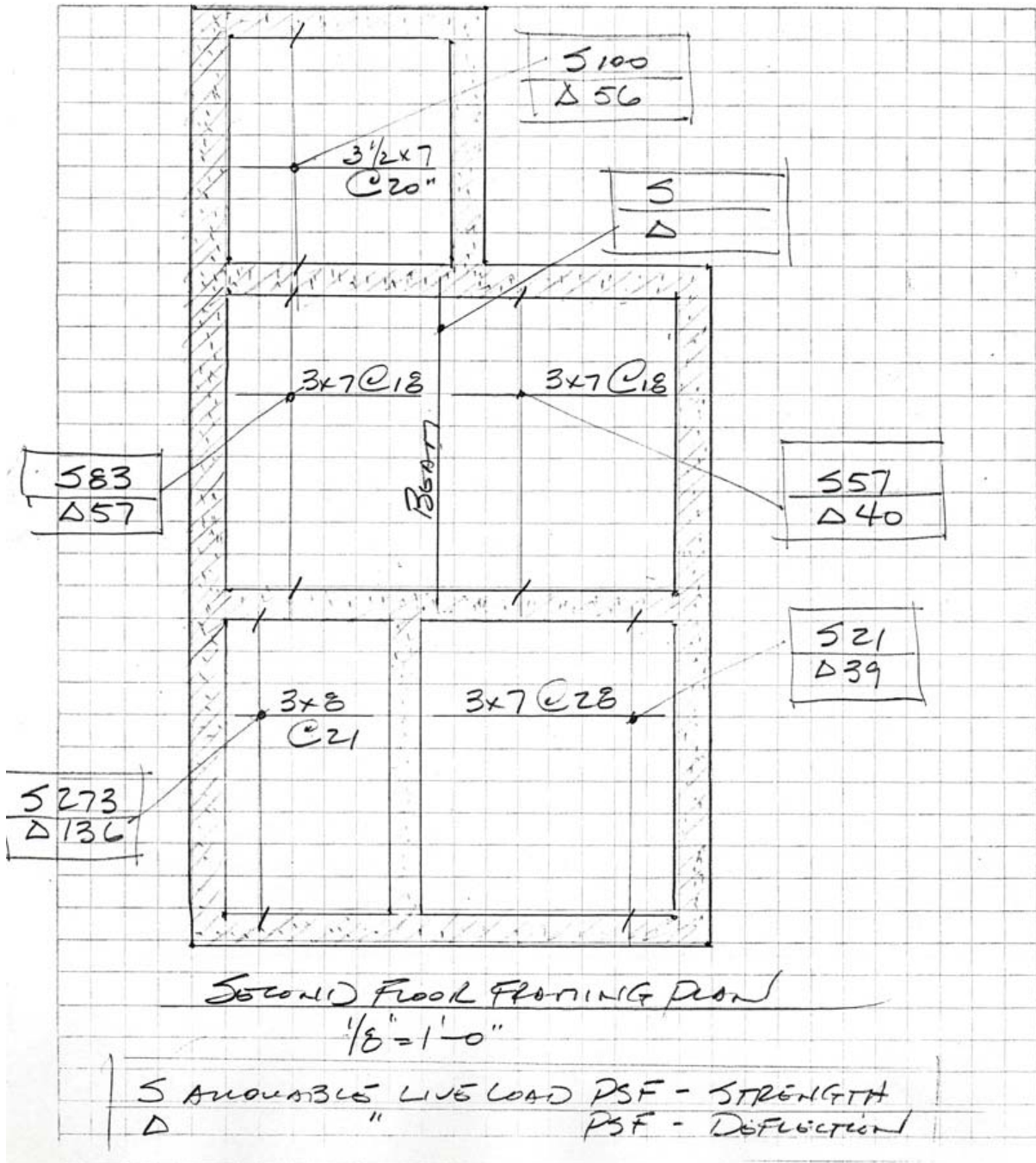


Figure S-2: Sketch of Second Floor Framing Plan. (Note: Image is not to scale).

**GREDELL  
& ASSOCIATES**  
 STRUCTURAL ENGINEERS

5700 KIRKWOOD HIGHWAY • SUITE 206 • WILMINGTON, DELAWARE 19808 • 302-996-9500

PROJECT Stirling

WD 554,132 SHEET 3 OF 4

CALCULATED BY Cruc DATE 5 Feb 05

CHECKED BY \_\_\_\_\_ DATE \_\_\_\_\_

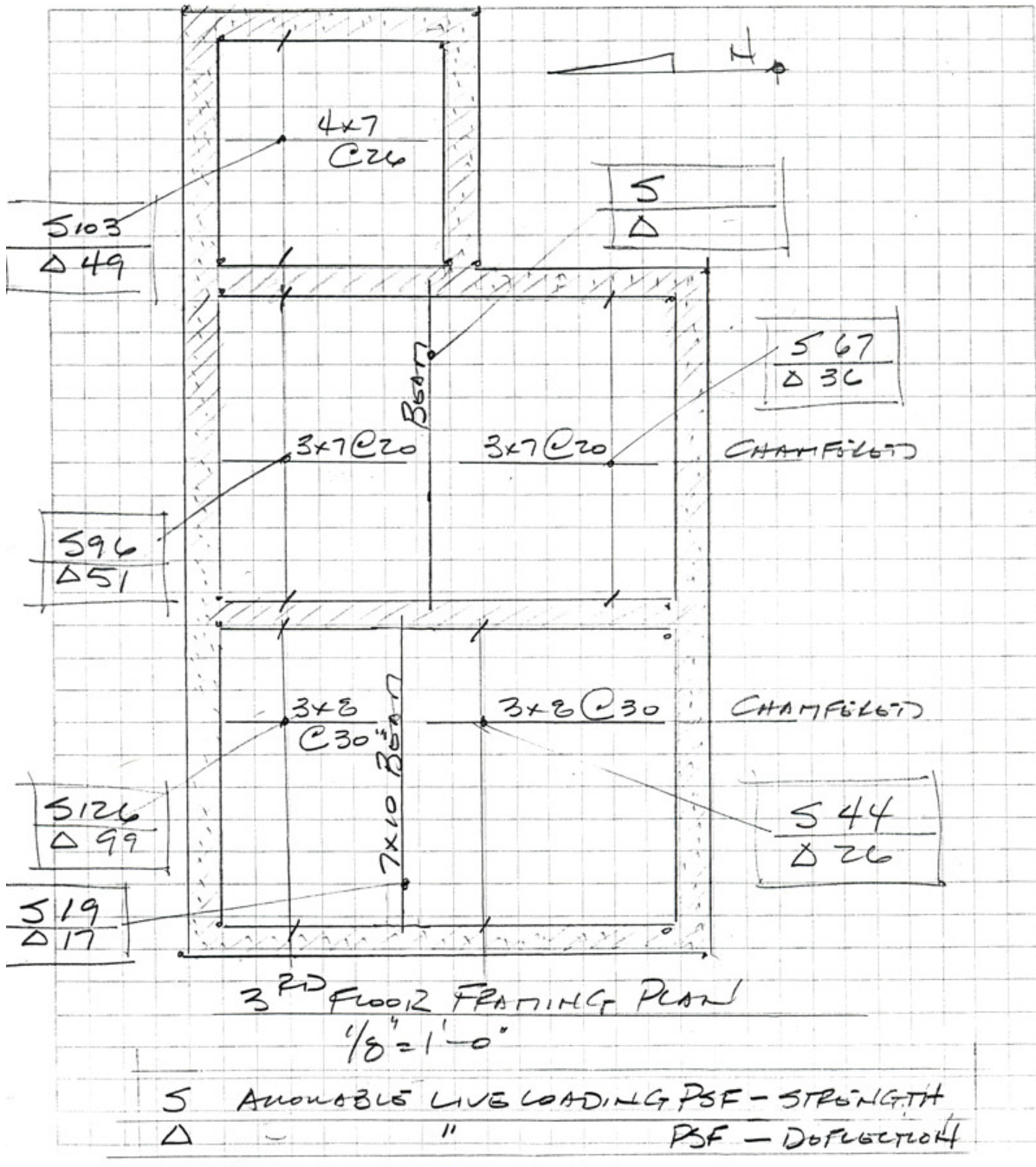


Figure S-3: Sketch of Attic Floor Framing Plan. (Note: Image is not to scale).



**GREDELL  
& ASSOCIATES**  
STRUCTURAL ENGINEERS

5700 KIRKWOOD HIGHWAY • SUITE 206 • WILMINGTON, DELAWARE 19808 • 302-996-9500

PROJECT Stirling  
WG 554.132 SHEET 4 OF 4

CALCULATED BY Am DATE 5 Feb 05

CHECKED BY \_\_\_\_\_ DATE \_\_\_\_\_

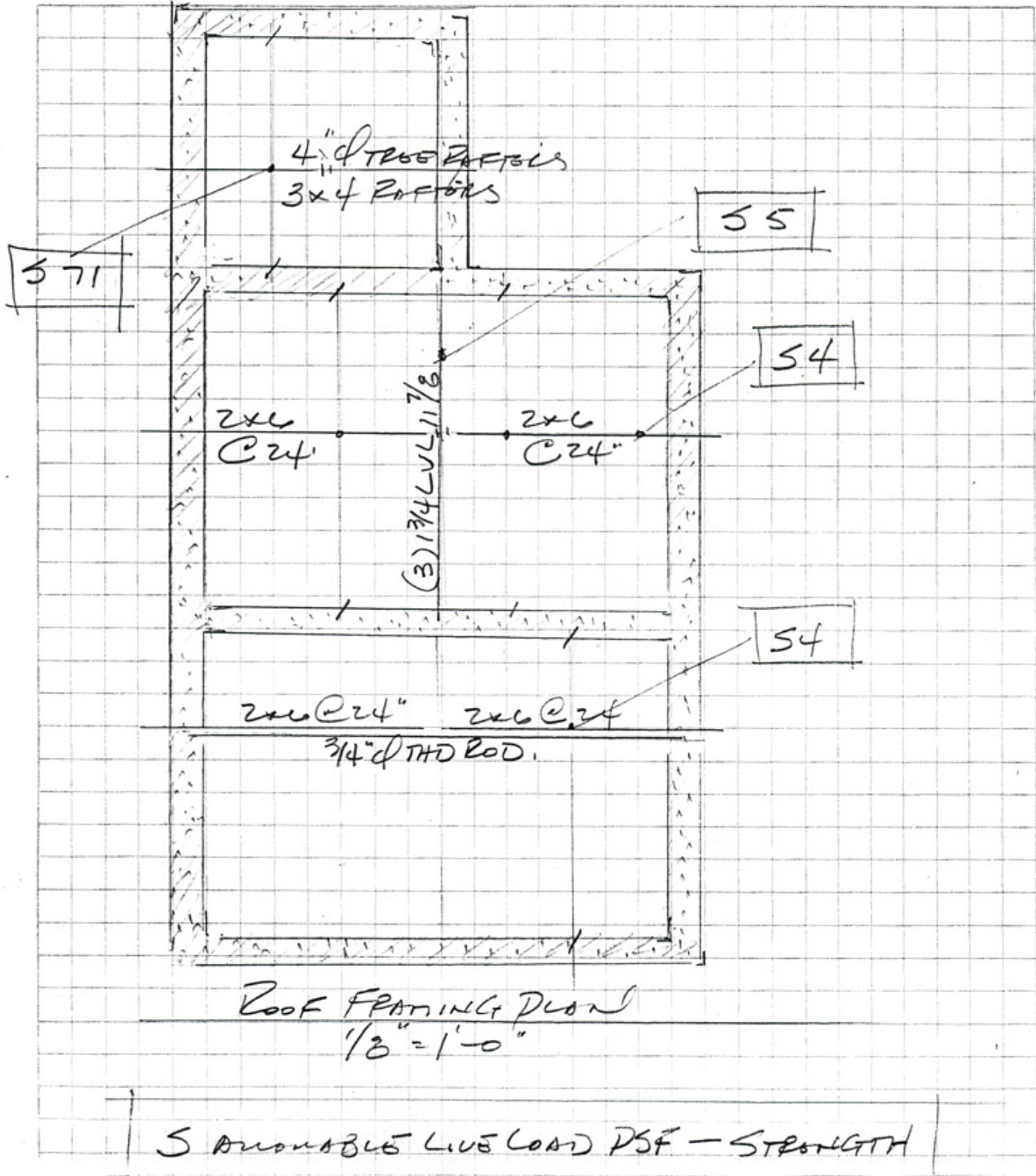


Figure S-4: Sketch of Roof Framing Plan. (Note: Image is not to scale).



**GREDELL  
& ASSOCIATES**  
STRUCTURAL ENGINEERS

5700 KIRKWOOD HIGHWAY • SUITE 206 • WILMINGTON, DELAWARE 19808 • 302-996-9500

PROJECT STIRLING

NO. 554.132 SHEET 1 OF 3

CALCULATED BY Cme DATE 20 JUL 05

CHECKED BY \_\_\_\_\_ DATE \_\_\_\_\_

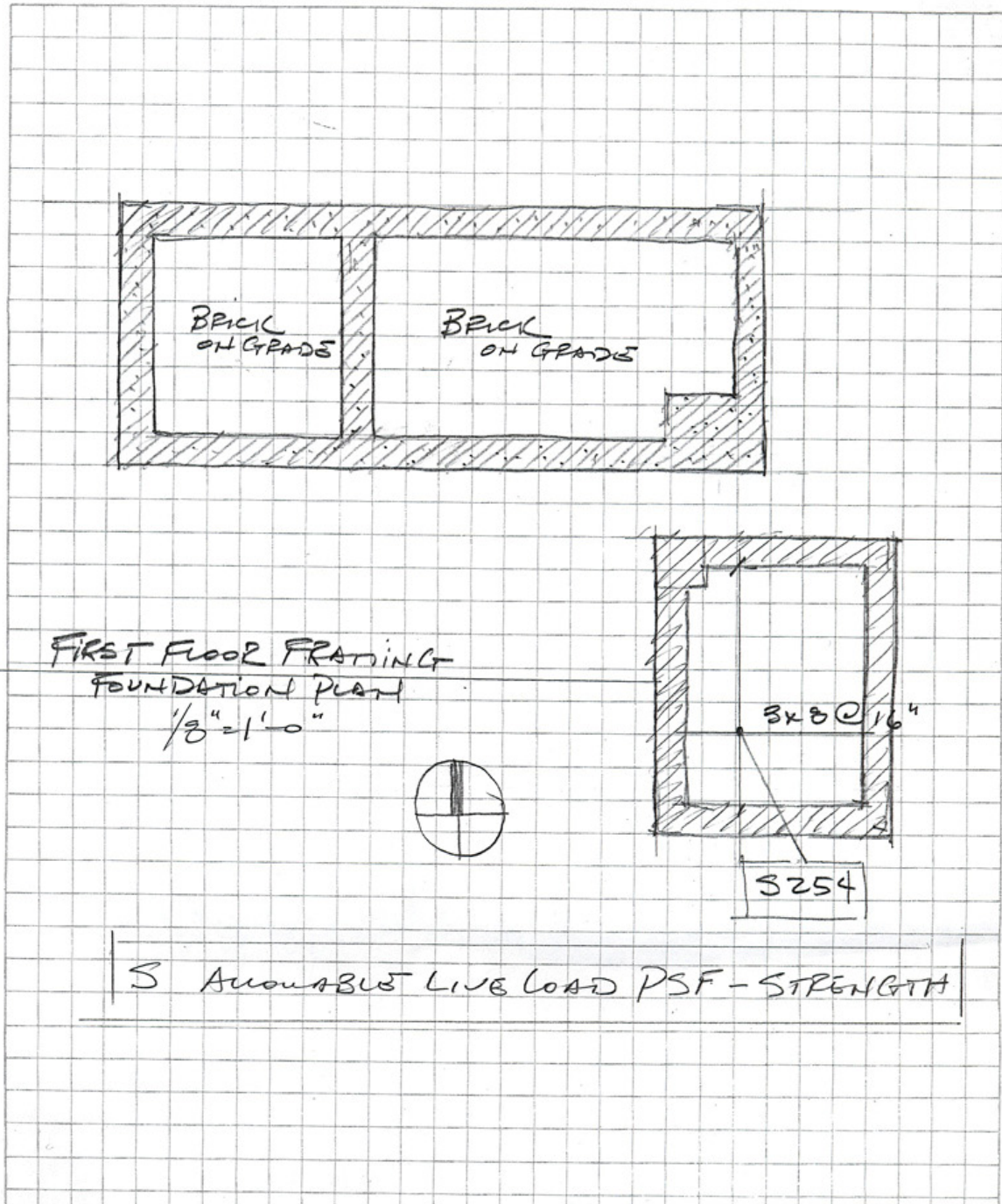


Figure S-5: Sketch of First Floor Framing Plan at 1926 northwest addition. (Note: Image is not to scale).

**GREDELL  
& ASSOCIATES**  
 STRUCTURAL ENGINEERS

5700 KIRKWOOD HIGHWAY • SUITE 206 • WILMINGTON, DELAWARE 19808 • 302-996-9500

PROJECT STIRLING

NO. 554.132 SHEET 2 OF 3

CALCULATED BY Guy DATE 20 JUL 05

CHECKED BY \_\_\_\_\_ DATE \_\_\_\_\_

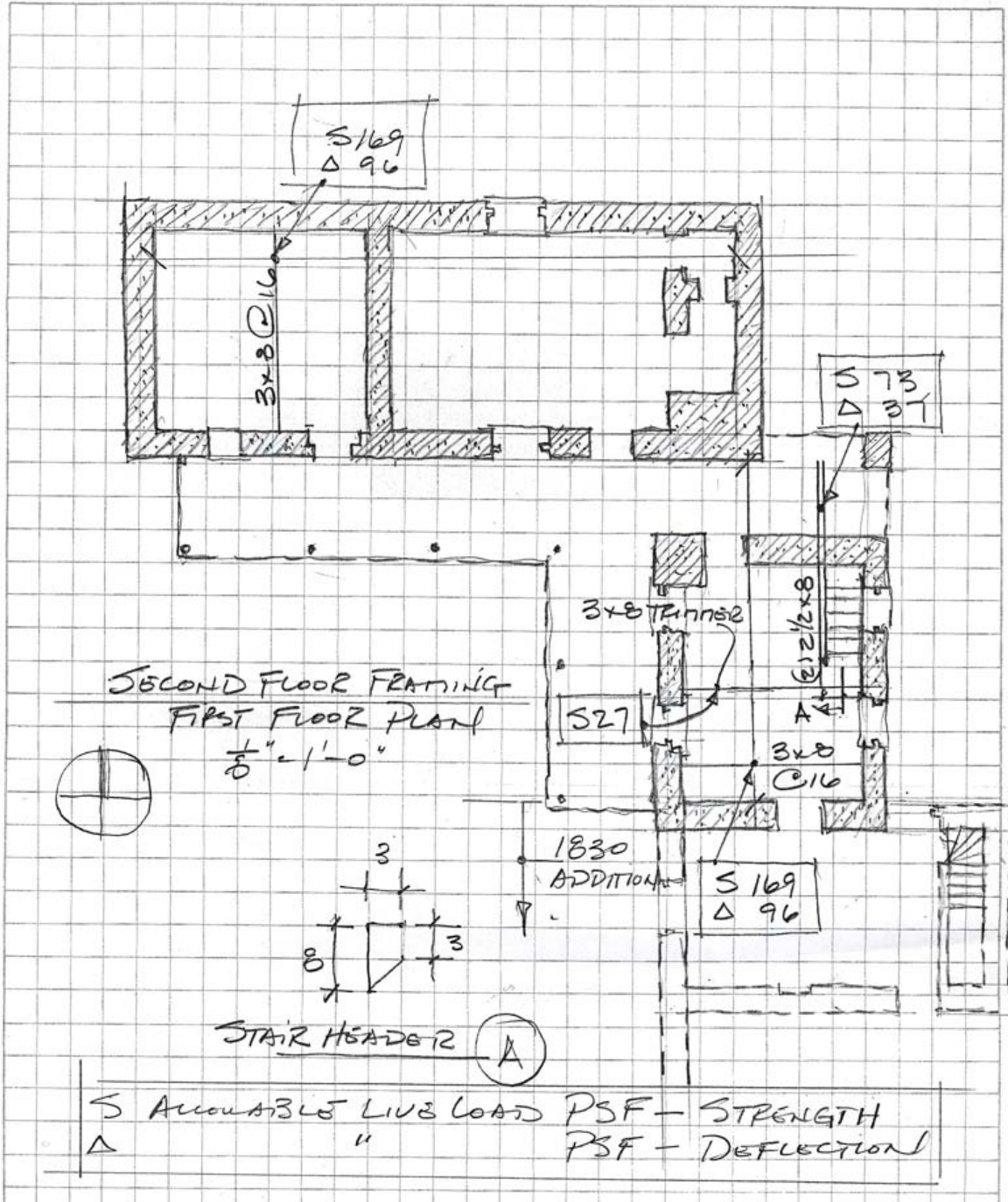


Figure S-6: Sketch of Second Floor Framing Plan at 1926 northwest addition. (Note: Image is not to scale).



**GREDELL  
& ASSOCIATES**  
STRUCTURAL ENGINEERS

5700 KIRKWOOD HIGHWAY • SUITE 206 • WILMINGTON, DELAWARE 19808 • 302-996-9500

PROJECT STIRLING

WO. 554.132 SHEET 3 OF 3

CALCULATED BY Qu DATE 20 JUL 05

CHECKED BY \_\_\_\_\_ DATE \_\_\_\_\_

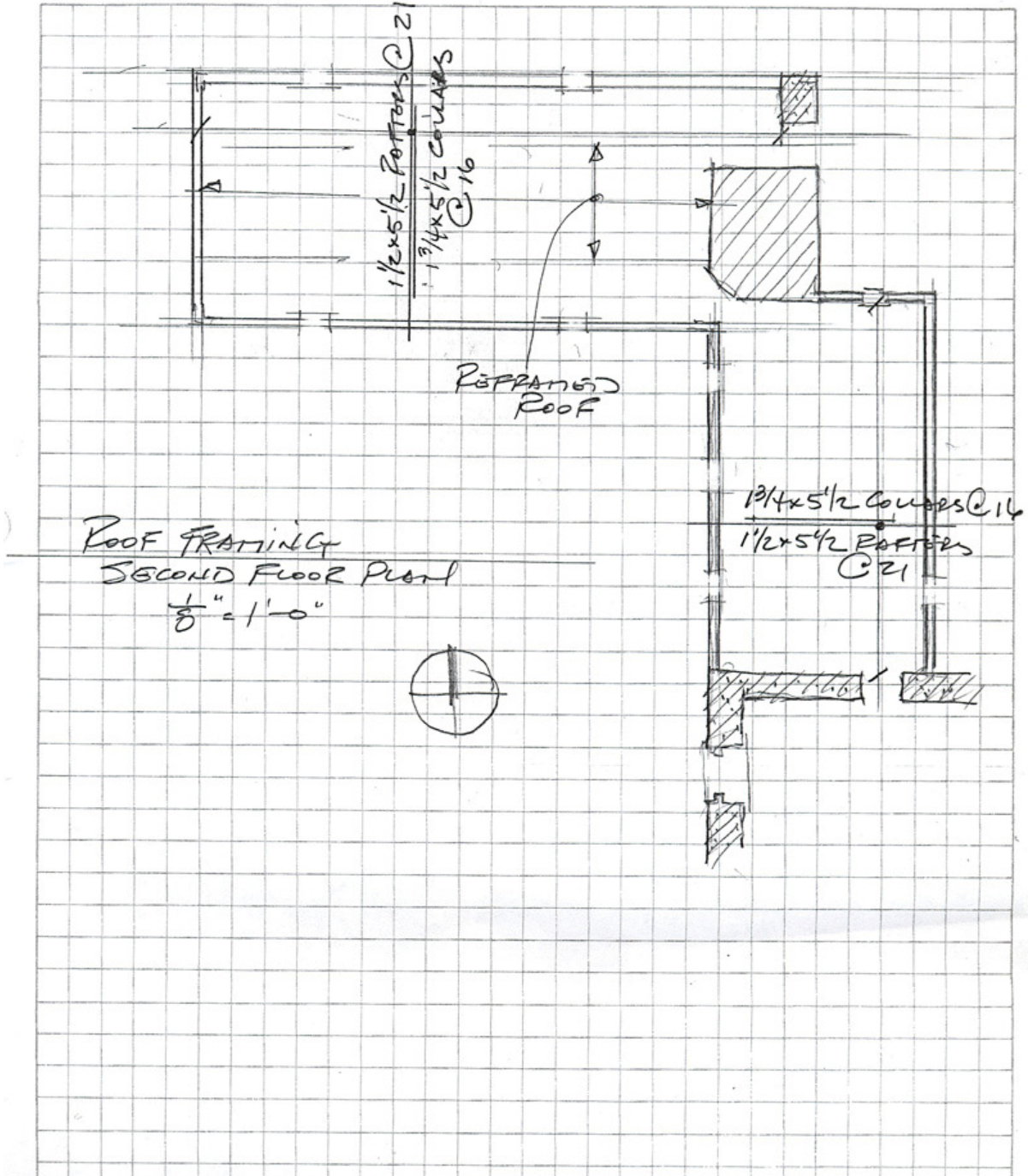


Figure S-7: Sketch of Roof Framing Plan at 1926 northwest addition. (Note: Image is not to scale).

### Main (Center) Block, c. 1769

The main block, which measures in plan approximately 31'-0" north-south by 22'-0" east-west, is built over a full basement and rises on uncoursed, rubble stone walls 2½ stories to a gable form roof. The first floor is framed with 3x7 wood joists set at 26" centers, spanning north-south, and bearing on the exterior masonry walls and flush framed to a central timber summer beam spanning east-west. The joist spans are asymmetric, 13' to the north and 15' to the south. For the longer span, a more recent 8x8 timber beam (east-west) underframes the floor joists; halving the spans and thereby stiffening the floor. The primary central beam is supported by the foundation for the corner fireplaces and chimney mass (east), a central 6x6 post, and the exterior west wall of the block. The first floor farming is in poor condition with approximately half the joists partially consumed by termite infestation. Both of the diagonally running hearth headers are in poor condition. The central summer beam is severely checked exhibiting cracks parallel to the grain. The central post is set into the concrete floor where damp is a concern with regard to serviceability. In addition, the timber lintel at the passage to the east addition is rotten and requires replacement.



For the longer span, a more recent 8x8 timber beam (east-west) underframes the floor joists; halving the spans and thereby stiffening the floor. The primary central beam is supported by the foundation for the corner fireplaces and chimney mass (east), a central 6x6 post, and the exterior west wall of the block. The first floor farming is in poor condition with approximately half the joists partially consumed by termite infestation. Both of the diagonally running hearth headers are in poor condition. The central summer beam is severely checked exhibiting cracks parallel to the grain. The central post is set into the concrete floor where damp is a concern with regard to serviceability. In addition, the timber lintel at the passage to the east addition is rotten and requires replacement.

The framing of the second and attic floors is provided by 3x7 joists set at approximately 20" centers spanning north-south. An east-west running summer beam, positioned 2' north of the geometric center of the building, is concealed at both levels. At the attic floor on the south side, the joists are dressed with chamfered corners. The framing appears to be in good structural condition. The allowable tributary live loading for the floor is limited by the deflection of the joists on the south side to 36 PSF. This is without consideration of the summer beam, since it is concealed and its capacity is unknown.

The gable form roof structure of the main block has been reframed with 2x6 rafters set at 2' centers supported by collar members bearing on a manufactured timber beam (3) 1¾ LVL 11⅞ spanning east-west. The allowable uniformly distributed live loading on this reframed roof is only 5 PSF, which is considerably less than the minimum loading recommended by the building code of 15 PSF.

**Recommendations:** At the first floor, carefully remove the flooring, rotten joists and diagonal hearth headers. Replace the members in kind or reframe the floor with double 2x8 pressure-treated, "select structural" members set into the original wall pockets and supported by metal framing connectors. Repair the severe check in the summer beam with a combination of epoxy and bolting. Damp-proof the bottom of the central post that is currently set into the concrete basement floor. Replace the timber lintel at the passage to the east addition basement.

The capacity of the roof may be enhanced by sistering the rafters and installing diagonal bracing (tied at the bottom) to decrease the span on the east-west roof beam.



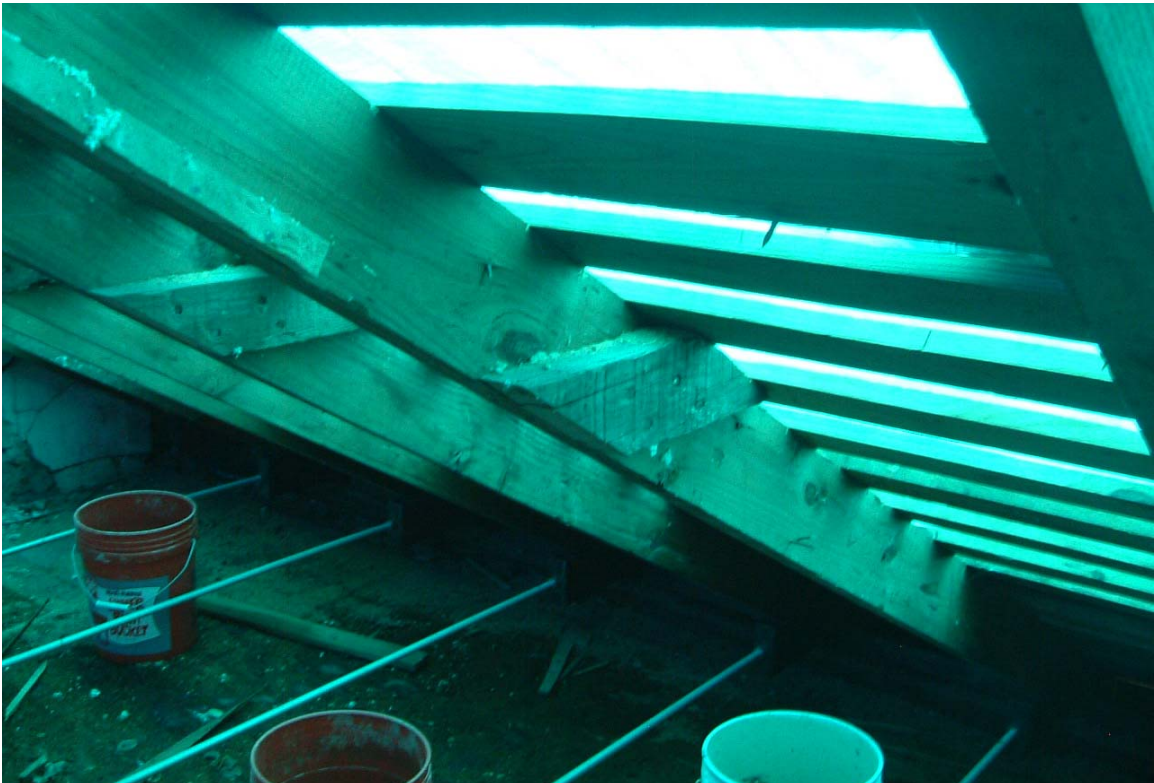
### West Kitchen Block, c. 1769, and North Addition, c. 1810

The first floor framing of the original kitchen is installed over a shallow crawl space and is comprised of 8" diameter tree joists spanning north-south and bearing on the exterior masonry walls and an interior row of central piers formed from dry stack stones. The joists are in poor condition with extensive termite damage, particularly at the south end adjacent to the bearings. The 9x8 hearth header has very little section remaining due to the extent of the infestation. (The original framing configuration, with the piers in place, provided enough strength to support a uniformly distributed live load of approximately 300 PSF. Even according to current building code and good practice, there is no need to provide for such a high loading in the repaired structure.)



The plan of the northwest addition to the original kitchen measures about 12' north-south by 20' east-west. All of the first-floor joists have been removed. Based on some remaining evidence at the northwest corner, it appears that the framing consisted of 3x8 joists spanning north-south and bearing on the masonry walls. These members could safely support a tributary live loading of 140 PSF.

The floor framing of the second and attic floors of this block appear to be in good condition with 3x7 members at 28" centers in the 1769 kitchen block and 3x8 members at 21" in the northwest addition. The second floor joists in the 1769 kitchen block are visually enhanced with beaded corners. Strength is not an issue for the floor framing in the northwest addition; however, in the 1769 section, the allowable safe live loading for the floor is limited by strength to 21 PSF. At the attic level, the joists at the south span are chamfered to improve the exposed appearance. The capacity of the third floor is limited by stiffness to 26 PSF.



The roof of the west block has been reframed with 2x6 rafters placed at 24" centers, tied at the bottom by a  $\frac{3}{4}$ " diameter threaded rod, and coupled to the base of the rafter with a bolted steel plate connector. The allowable uniformly distributed live (snow) load capacity of the roof structure is 4 PSF. This matches the allowable loading of the original block which is considered inadequate, meeting only  $\frac{1}{3}$  of the minimum recommended by the building code. The threaded rod tie and connector assembly is sufficiently strong enough to address the thrusting at the base of the rafter under code recommended snow loading.

Recommendations: Provide ventilation and damp proofing of the crawl space. Replace the stone piers with concrete masonry set on new footings and reframe the floor with pressure treated timber of similar section to the tree joists so that masonry bearings can be reused. Since it would be difficult to provide adequate ventilation in this area without excavating, which would cause concern regarding the undermining of the exterior wall foundation, damp-proofing and subsequently casting a slab on grade with wood sleepers and wood deck may be the best approach for restoring the floor structure in this addition. It should be noted that further archeological investigation and documentation of the space would be necessary as a mitigation measure for either approach.

The joists at the second and attic floors are in good condition with no repairs needed. In the event a greater capacity for floor loading is required, the joists at all levels can be strengthened by sistering; however, decorative chamfers and beads would be concealed by ceiling finishes that would be needed to cover the unsightly sistering work.

In order to provide the required capacity of the roof structure, the rafters will also need to be strengthened by sistering. As an alternative to the threaded rod ties, a structural ridge could be provided by a lightweight east-west attic truss.

### East Addition, c. 1830

Constructed of uncoursed, rubble stone masonry, the east addition rises two levels over a full basement. The first floor is framed with 3x8 joists at 21" centers spanning north-south and bearing on the exterior masonry. Termite damage is prevalent, similar to the condition of the first floor throughout the building. At least 3 of the joists have been consumed by termite infestation. Provided the joists are replaced with similar section and strength, the allowable live loading would be approximately 100 PSF.

The framing of the second and attic floors are in good structural condition with 3½x7 members at 20" centers at the second floor and 4x7 members at 26" centers at the attic floor. The allowable live loading at both floors is limited by the stiffness of the joists to approximately 50 PSF. No repairs are required for these members provided the allowable live loading meets the proposed programming requirements for the space.

Portions of the roof framing are concealed by insulation board that has become wet due to leaking of the temporary tarp that had been covering the roof. Rafters that can be observed include a combination of 4" diameter tree rafters and 3x4 hewn members. Ridge connections are pinioned open mortise and tenon and appear to be original to the structure. They are the only original roof framing members found in the building.

Recommendations: Replace the deteriorated first-floor framing with pressure treated members of similar section.

### Northwest Addition, c. 1926

The 1926 addition is basically L-shaped in plan with the north-south leg attached to the northwest corner of the c. 1810 kitchen addition. The other leg is oriented east-west over the springhouse/bakehouse. The plan form of the first level consists of two separate masonry blocks separated by an open passage approximately 4' in width. At second and roof levels, the construction is continuous. Both segments of the addition rise on thick stone masonry walls to a platform-framed, second level. The masonry is laid up as uncoursed, rubble stone and appears to be in good condition. At the second level, the walls are framed in timber with clapboard siding. The walls rise to a gable form roof.

The first floor of the south block is framed with 3x8 joists set at 16" centers, spanning east-west over an earthen subgrade situated less than a foot below the bottom of the joists. The space below the framing is unventilated. Poor site drainage adjacent to the east wall of the south block has caused wet conditions in the stone masonry. Finding favorable environment, termite infestation has consumed the eastern ends of the joists.

The second floor of the addition is framed with 3x8 joists at 16" centers. The allowable live load capacity of the framing, in general, is limited by the stiffness criteria to slightly less than 100 PSF. At the southern section of the addition, a 3x8 trimmer spanning east-west has been dapped to accommodate the desired head clearance at the stairway. The resultant reduced section adversely





affects the shear strength. Accordingly, the live load capacity of approximately 60 SF of floor is limited to less than 30 PSF.

The roof is gable form and framed with 1½" x 5½" rafters at approximately 21" centers. The rafters are tied with the attic floor joists which are the same section, but set at 16" centers. The attic floor joists bear on a 3x5 member (purlin orientation) that spans between the rafters. Although the framing arrangement is somewhat uncommon, the stability of the assembly is evidenced by a straight eave line and plumb second-level walls.

In the north block of the addition, the upper portions of the roof framing have been replaced. The char that can be observed on some of the members is witness to a fire, which probably started in the chimney located at the east end of the north block. The subsequent repair of the roof structure involved removal of the damaged upper half of the roof, including the ridge, and then splicing on a replacement roof. The approach allowed the eave and attic section to remain intact, which simplified the repair.

Unfortunately, the method of splicing the rafters was poorly conceived. The damaged rafters were square cut and the ridge section of the roof was removed. Then a 2x6 wood plate purlin was end nailed to the cut rafters. This provided a means for toe-nailing the replacement rafters that form the ridge of the roof. The connection has no bending strength and as a result has separated due to the tension at the bottom of the splice, causing noticeable sag in the member.



Recommendations: Regrading the site to lower grade and provide positive drainage away from the building appears difficult to achieve. Accordingly, remove the timber joists at the first floor of the south block and replace with slab on grade construction. Excavate the subgrade inside the building; install vapor barrier and 4" of stone prior to casting a 4" thick concrete slab. Install pressure treated furring strips and marine plywood subfloor in preparation of the placement of the finish flooring. Coordinate the requirements of HVAC and piping.

At the second floor where the 3x8 trimmer has been modified to accommodate head clearance at the stair, remove portions of the plaster ceiling and reinforce the 3x8 trimmer with double 2x8 sisters connected with bolts to the south face of the existing member.

At the north block roof, reinforce the splice with flat metal straps nailed to the bottom of each rafter. The cross-sectional area of the strap and number of nails at each side of the splice must address the tension and shear forces in the strap and the nails, respectively, when the roof is loaded with snow.



### Summary Structural Evaluation

The first-floor framing throughout the building is in poor condition due to a combination of moisture at the bearings and infestation by termites. Damaged and deteriorated timber, which approaches over half the original members, should be removed and the building be treated by a certified pest control firm to ensure that there is no termite activity in and around the building. The framing of the first floor (except at the south block of the 1926 addition) may be replaced in-kind whereby the original framing sizes and joinery could be replicated or, alternatively, conventional framing may be used to provide a floor structure that meets the proposed loading requirements of the floor. A decision must be made regarding the preferred method of addressing the structure of the first-floor framing. Based on what has been previously done with regard to replacement of the rafters, it appears that replacement with conventional framing is an acceptable alternative. At the south block of the 1926 addition, replacement of the existing wood joist framing with slab on grade construction furred and decked with marine plywood is recommended.

The upper floors of the building are in good structural condition with the strength of the members meeting the live loading requirements for office use (50 PSF), except for the framing at the second floor above the 1769 kitchen, the attic floor summer beam in the same block, and the modified trimmer at the south block of the 1926 addition. The greatest limitation with regard to future use is the stiffness of the framing on the south side of the building at both the second and attic levels of the building. Strengthening and stiffening can be provided by sistering; however, where the framing was originally exposed (chamfered and beaded corners) some decisions must be made regarding finishing of the ceilings. An additional concern is the capacity of the concealed summer beams at both the second and attic floors of the main block. These members must be uncovered in order to determine their structural properties.

Except for the original roof framing of the east addition, the current roof framing of the main building as a whole is typically undersized with only 1/3 the recommended capacity for snow loading. It is recommended that these members be reinforced by sistering. Reinforcement of the peculiar splicing observed at the roof of the north block of the 1926 addition is also recommended; otherwise, the load capacity of the existing gable roof framing of the 1926 addition should be adequate.

## 1.5 MATERIALS ANALYSIS



## 1.5 MATERIALS ANALYSIS

Stucco, plaster, and mortar samples (40 total) were taken and analyzed for the purpose of providing further physical evidence towards understanding the evolution of the interior and exterior of the building.

Samples such as these can reveal important information about a building's evolution in terms of weathering, surface finishes and original materials. For instance, sand used for a particular mortar or stucco mixture typically comes from a local source (i.e., a dried river bed or sand pit) which has been chosen by the owner or person preparing the mix. The source of the aggregate, assuming it is reliable, may have been used frequently during the tenure of a particular person. Although this information cannot determine whether samples are necessarily from the same application date, it can reveal that the samples are contemporary of a particular owner or relative time period. Differences in aggregate may correspond to a different source of sand and thus a different owner and/or period of construction.

Further chemical and physical analyses of these samples and their individual constituent parts may reveal additional information regarding specific sources of materials and significant alterations over time. A comparative study of information attained from studying other building features and materials can provide supplementary data for the accurate intervention and interpretation of the building.

### Methodology

The stucco, plaster, and mortar samples taken from the building were matched visually according to binder type (i.e., gypsum, lime, or portland cement), overall color and texture, aggregate size and texture, finish layers (i.e., limewash or paint), additives (i.e., brickdust and animal hair), and size of lime particles (where applicable). The individual samples were then grouped based on similar material characteristics. Seven associative groups were identified (Groups A through G). Each sample was analyzed under magnification to obtain a clearer understanding of aggregate particle size, shape, and color. This information was used to create more defined matches within the groups (see Table 4). Several samples remained unmatched after analysis and have been interpreted individually.

### Summary of Findings

A catalog of all of the material samples is provided in Table 4, including the sample type, a brief visual description of the material, and the locations from which the samples were taken. Based on visual observation as described above, the material samples have been grouped according to composition and physical characteristics. General descriptions and interpretations of each of the material groupings are included below. All samples are also keyed to the elevation drawings included in the Physical Description section (Section 1.3) of this report.

### Group A

Samples: 01, 03, 04, 05, 09, 27, 33

General description: Lime-based, pink/buff in color, contains brick dust, and limewash finish.

Group-A mortar and stucco samples collectively represent the most common exterior finish material, apart from the various 20<sup>th</sup>-century stuccoes, and likely correspond to a large-scale exterior refinishing campaign. Analysis of several samples taken from the south, west and portions of the north elevation suggest that these exterior facades were most likely stuccoed concurrently. The similarity between the mortar used above the "line" at the second floor interior of the west block, south wall (see discussion of Room 206 in the Physical Description section of this report) and the exterior stucco materials also supports the hypothesis that the building was stuccoed at the same time the west block was expanded to two full stories during the first part of the 19<sup>th</sup> century.

### Group B

Samples: 02, 20, 23, 31, 32, 36, 37, 38, 40

General description: Lime-based, pink/buff in color, similar aggregate as Group A, but has greater lime content.

These mortar samples were all taken from the exterior of the main block and the exterior walls of the original circa 1769 kitchen wing. The similarities among these mortar samples indicate that the original sections of the house (i.e., the main block and one-room kitchen wing) were pointed concurrently. The Group-B mortar found at the west wall of Room 303 and at the south wall of Room 106 also provide evidence of an early pointing campaign since these walls were initially exposed masonry walls. The stucco panel located at the west gable peak of the main block with the inscribed date of "1769" is also comprised of material that is more or less identical with the Group-B mortars. Material analysis suggests that the stuccoed date panel is also contemporary with the exterior pointing campaign and could possibly date to the circa 1769 period of original construction.

### Group C

Samples: 07, 15, 16, 21, 29

General description: Lime-based, cream/buff in color, contains brick dust, animal hair and other organic material.

Group-C plaster samples represent a general interior plaster campaign occurring throughout the main block. This plaster layer likely represents the original circa 1769 application or an otherwise early replastering. In most places, this first layer of plaster has been covered with a modern, cement-based, three-coat plaster which was likely added as part of the circa 1926 renovations to the building.



### Group D

Samples: 11, 17, 18, 19, 30, 39

General description: Three-coat lime-based plaster, tan/buff (brown coat), cream/buff (scratch coat), mostly fine aggregate, contains animal hair.

These plaster samples appear to represent a general interior plaster campaign that occurred throughout the west block of the house. Group-D plasters also appear to be first-layer applications, yet they differ from the Group-C plasters observed throughout the main block. It is likely that the interior spaces of the west block were plastered as part of a general interior renovation campaign at the time of the circa 1810 expansion.

### Group E

Samples: 06, 22

General description: Three-coat lime-based plaster, tan/buff (brown coat), red/brown (scratch coat).

The similarities between the Group-E plaster samples indicate that the interior spaces of the east addition were also plastered concurrently. The reddish-brown color of the scratch coat is very different from plaster found elsewhere in the building, but appears to be consistent throughout the east addition. Group-E plasters likely date to the initial construction period of the east addition, circa 1830.

### Group F

Samples: 25, 26

General description: Lime-based stucco, cream/buff in color, similar aggregate, same finish and high lime content.

The similarities between these two stucco samples, taken from the north elevation of main block and from the east elevation of main block (within the seam between the main block and east addition), indicate that the main block was stuccoed prior to the construction of the east addition. These samples, however, do not match the Group-A materials and, therefore, do not correspond to a single exterior stucco campaign. The surface texture of stucco Sample 26 matches that of Sample 14 (described below) which was taken from the east elevation of the main block below the east roof line, but the material composition of the two samples varies. One explanation for these discrepancies is that the various samples represent separate stucco and patching campaigns. The east wall of the main block may have been stuccoed along with the rest of the building after the west block was expanded circa 1810. It may also have been stuccoed prior to the west expansion and as early as the original construction period of 1769, as it was not uncommon for the east façade of an otherwise exposed masonry building to be stuccoed to protect against driving rains and harsh weather from the east. The stucco was likely patched in scattered areas sometime before the east addition was built circa 1830 as represented by these samples.

### Group G

Samples: 08, 28

General description: Cement-based plaster, grey in color, with animal hair and organic material.

These modern, cement-based, grey plasters represent 20<sup>th</sup>-century applications. The samples are not identical, but are very similar in composition. Sample 28 was taken from Room 102, south partition wall and provides evidence that the partition was replastered at some time in the 20<sup>th</sup> century. Sample 08, taken from the hall/closet partition wall at the second floor (Room 204A) of the main block, indicates that the closet was likely added as part of the circa 1926 renovations to the house. It also corroborates other evidence that the hall partition layout at the second floor has been reconfigured from its original 1769 configuration.

### Unmatched samples

Sample 10: Sample 10 is a lime-based mortar, cream/buff in color with large inclusions of lime and animal hair. It was taken from the south wall at the second floor of the west block below the horizontal "line" that denotes the previous 1½-story kitchen height prior to the circa 1810 expansion. Its composition is different than Sample 09 (Group A) which was taken from the same wall above the "line" (see discussion of Room 206 in the Physical Description section of the report). Material analysis, in this case, corroborates other evidence that the west block was indeed raised to two stories from a previous height of 1½ stories.

Sample 12: This is an early lime-based plaster, tan/buff in color with large aggregate, lime inclusions, and animal hair, taken from the chimney mass behind the mantel in Room 206. It is similar to the Group-D plasters, but appears to represent a separate type.

Sample 13: Sample 13 was taken from the east exterior wall of the main block just above the east roof. It is a lime-based stucco, cream/buff in color with fine aggregate and organic material. Compared with Sample 14 and Sample 26 from the same façade, it appears to represent a separate exterior stucco campaign that likely took place sometime after the east addition was built.

Sample 14: Sample 14 was taken from the east exterior wall of the main block just below the east roof. It is a lime-based stucco, tan/buff in color with a distinct surface appearance of large aggregate and limewash finish. The same stucco extends behind the east roof rafters and within the attic of the east addition. This suggests that the east elevation of the main block had been stuccoed before the east addition was built.

Sample 24: This stucco sample was taken from the north façade of the east addition at the location of the patched lintel pocket. It is the only exterior stucco that was applied to wood lath. Its unique characteristics suggest that it

represents a distinct patching campaign and may have only been used at this location.

Sample 34: This mortar sample was taken from the south elevation of the springhouse, near the seam between the springhouse block and adjacent bakehouse. The mortar is very similar in appearance and composition with the Group-B mortars, but includes a dark black aggregate material that does not appear in the Group B mortars.

Sample 35: The first layer of stucco at the bakehouse is a reddish-brown, lime-based material with large inclusions of lime and animal hair. Compared with other samples taken, it appears to represent a discrete stucco campaign unrelated to those of the main house.

HISTORIC STRUCTURE REPORT  
 STIRLING'S QUARTERS AT VALLEY FORGE NATIONAL HISTORICAL PARK

No.	Type	Location	Description	Group
01	stucco	main block, south elevation	lime-based, pink/buff color, brick dust, w/limewash finish	A
02	mortar	main block, south elevation	lime-based, pink/buff color, well-graded and evenly distributed aggregate, high lime content	B
03	stucco	west block, south elevation	lime-based, pink/buff color, brick dust, w/ limewash finish	A
04	stucco	west block (south end) west elevation	lime-based, pink/buff color, brick dust, w/ limewash finish	A
05	stucco	west block (north end) west elevation	lime-based, pink/buff color, brick dust, fine aggregate, w/ limewash finish	A
06	plaster	east block, room 301 east wall near window	lime-based, tan/buff color (brown coat), red/brown color (scratch coat)	E
07	plaster	main block, room 205 northeast of mantel	lime-based, cream/buff color, brick dust, animal hair, organic material	C
08	plaster	main block, room 205 north wall of closet	cement-based, grey color, animal hair, organic material	G
09	mortar	west block, room 206 south wall above "line"	lime-based, pink/buff color, brick dust	A
10	mortar	west block, room 206 south wall below "line"	lime-based, cream/buff color, large inclusions of lime, animal hair	--
11	plaster	west block, room 206 west wall, mantel	lime-based, tan/buff color (brown coat), cream/buff color (scratch coat), fine aggregate, animal hair	D
12	plaster	west block, room 206 west wall, chimney	lime-based, tan/buff color, large aggregate, animal hair	--
13	stucco	main block, east wall above east roofline	lime-based, cream/buff color, fine aggregate, organic material	--
14	stucco	main block, east wall below east roofline	lime-based, tan/buff color, large aggregate at surface, w/ limewash finish	--
15	plaster	central block, room 203 west wall	lime-based, cream/buff color, brick dust, animal hair, organic material	C
16	plaster	main block, room 202 north wall	lime-based, cream/buff color, brick dust, animal hair, organic material	C
17	plaster	west block, room 207 east wall	lime-based, tan/buff color (brown coat), cream/buff color (scratch coat), fine aggregate, animal hair	D
18	plaster	west block, room 303 west wall	lime-based, tan/buff color (brown coat), cream/buff color (scratch coat), fine aggregate, animal hair	D
19	plaster	west block, room 303 east wall	lime-based, tan/buff color (brown coat), cream/buff color (scratch coat), fine aggregate, animal hair	D
20	mortar	west block, room 303 east wall	lime-based, pink/buff color, well-graded and evenly distributed aggregate, high lime content	B



No.	Type	Location	Description	Group
21	plaster	main block, room 103 south wall	lime-based, cream/buff color, brick dust, animal hair, organic material	C
22	plaster	east block, room 101 west wall	lime-based, tan/buff color (brown coat), red/brown color (scratch coat)	E
23	stucco	main block, west wall recess at gable peak	lime-based, pink/buff color, well-graded and evenly distributed aggregate, high lime content	B
24	stucco	east block, north elevation at lintel pocket	lime-based, tan/buff color	--
25	stucco	main block, north elevation near seam with east block	lime-based, cream/buff color, high lime content	F
26	stucco	main block, east elevation at seam with east block	lime-based, cream/buff color, high lime content	F
27	stucco	west block, north elevation	lime-based, pink/buff color, brick dust, w/ limewash finish	A
28	plaster	main block, room 102 south partition wall	cement-based, grey color, animal hair, organic material	G
29	plaster	main block, room 103 south wall	lime-based, cream/buff color, brick dust, animal hair, organic material	C
30	plaster	west block, room 104 east wall	lime-based, tan/buff color (brown coat), cream/buff color (scratch coat), fine aggregate, animal hair	D
31	mortar	main block, north elevation	lime-based, pink/buff color, well-graded and evenly distributed aggregate, high lime content	B
32	mortar	main block, west elevation at seam with west block	lime-based, pink/buff color, well-graded and evenly distributed aggregate, high lime content	B
33	stucco	main block, north elevation	lime-based, pink/buff color, brick dust, w/ limewash finish	A
34	mortar	springhouse, south elevation	lime-based, pink/buff color, brick dust, some dark aggregate, high lime content	--
35	stucco	bakehouse, south elevation	lime-based, red-brown/buff color, large inclusions of lime, animal hair	--
36	mortar	west block, west elevation	lime-based, pink/buff color, well-graded and evenly distributed aggregate, high lime content	B
37	mortar	west block, south elevation	lime-based, pink/buff color, well-graded and evenly distributed aggregate, high lime content	B
38	mortar	west block, room 106 south wall near window	lime-based, pink/buff color, well-graded and evenly distributed aggregate, high lime content	B
39	plaster	west block, room 106 south wall near window	lime-based, tan/buff color (no scratch coat), fine aggregate, animal hair	D
40	mortar	west block, south elevation	lime-based, pink/buff color, well-graded and evenly distributed aggregate, high lime content	B

**PART 2**  
**TREATMENT AND USE**



## 2.1 TREATMENT PHILOSOPHY



## **PART 2. TREATMENT AND USE**

### **2.1 TREATMENT PHILOSOPHY**

Without considering future adaptive uses of the building, the restoration and preservation of Stirling's Quarters could potentially focus on several time periods.

A restoration period of 1769-1778 incorporates the time period of William Currie's construction of the original sections of the house, as well as the period of the Valley Forge encampment and Stirling's supposed occupancy. This time period would require removal of all later additions, including many early 19<sup>th</sup>-century elements. While much of the period appearance can be determined, many of the details, such as mantels, would be speculative and many more of the finishes would be reproduction since so much of the 1769 finishes have since been lost or replaced. The reduction of the building size to the 18<sup>th</sup>-century configuration also greatly reduces the usable square footage of the building and possibly limits the feasibility of certain adaptive uses.

A restoration period of c. 1790-1830 incorporates many of the significant additions and changes to the structure. However, aside from the building form, many of the c. 1790-1830 elements were replaced or modified in the 20<sup>th</sup> century. Reconstruction to this period would require substantial construction such as rebuilding the large cooking fireplace in the north addition and the winder stairs in the west wing. All of the 1926 additions would also need to be removed. The National Register Nomination form does not identify this period as significant.

A restoration period of c. 1926-present incorporates the large expansion and significant modifications undertaken by the Ligget family. As noted in the Chronology of Development and Use and the Physical Description sections of this report, the Ligget family replaced and modified many of the original interior finishes as well as exterior building components including lowering of the c. 1810 west wing roof and removing the c. 1810 cooking fireplace and chimney. Of course, the usable square footage would also be maximized by not removing any of the additions. Even with all of the later additions in place, the incremental and historic evolution of the structure is still quite clear from the front (south) elevation. Interpretation could then focus on the entire evolution of the building.

In consideration of these options, and the requirements of the Park for reuse, preservation and renovation of the building to its appearance circa 1926 is the most appropriate action. The recommendations presented for treatment and treatment priorities are based on this course of action.



## 2.2 CHARACTER DEFINING FEATURES



## 2.2 CHARACTER-DEFINING FEATURES

To aid in the process of planning for the preservation, treatment and potential reuse of Stirling's Quarters, a general summary of the character-defining features is provided below including a list of extant exterior and interior elements which contribute to the architectural and visual character of the property. Missing features that would be considered character-defining are also listed where archival or physical evidence indicates that they were once present.<sup>62</sup> Given that the building has undergone multiple construction and renovation campaigns, a more detailed accounting of the character-defining features is also provided according to the three proposed restoration periods identified in Section 2.1 - Treatment Philosophy.

### Character-Defining Features - Overview

#### Exterior Features

- Hillside setting of farmhouse; orientation to the south
- Relationship with surviving outbuildings - springhouse/bakehouse and small barn
- Form and massing of the building as indicative of vernacular type and building evolution
- Wood shingle roofs with wood box cornices (replacement)
- Multiple roof lines associated with distinct blocks and building evolution including recess/peak at west gable end
- Pent and porch roofs at north and south elevations (replacement)
- Multiple stone gable-end chimneys
- Existing period fenestration - wood frames/single-hung wood sash of various configurations
- Shutters at first floor windows (missing)
- Existing period door openings - wood frames, board and panel doors
- Exterior fieldstone masonry with several campaigns of stucco finishes
- Inscribed initials and dates at south façade; stucco date panel at west gable of main block
- Beehive bake ovens (missing)

#### Interior Features

- Floor plan and general arrangement of interior spaces including level changes
- Random-width wood floors (replacement)

---

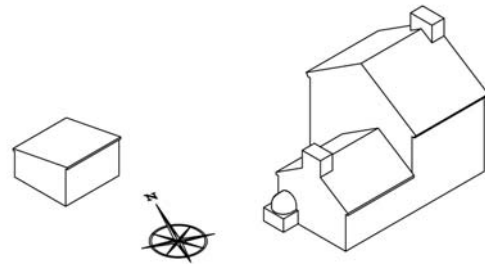
<sup>62</sup> For additional information regarding period building materials that survive in situ and evidence for missing and removed features, see Section 1.3 - Physical Description.

- Plaster ceiling finishes and exposed wood floor framing and board flooring
- Plaster wall finishes
- Rounded plaster jambs at period window openings
- Enclosed winder stairs (sections missing) including partition walls and doors
- Fireplaces in existing locations (with replacement mantels)
- Interior wood panel doors/frames at first floor of main block
- Wood trim including existing period chair rails, window sills, etc., in scattered locations

### Character-Defining Features - Relative to Proposed Restoration Periods

#### 1769-1778.

The 1769-1778 period encompasses the original construction by William Currie and represents the appearance of the building during the Encampment. An accurate restoration of the building to this period would require a considerable degree of conjecture, particularly at the interior.



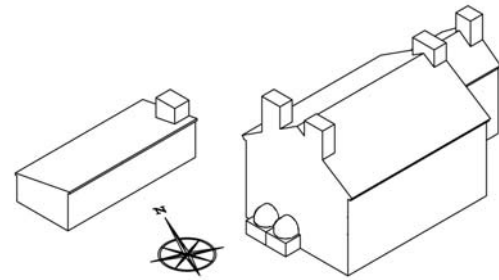
c. 1778

- Setting - open farm landscape; hillside orientation to south
- Shape - 2-story main block with original 1-story west kitchen; detached springhouse to the north
- Roof and Roof Features - gabled wood shingle roofs; two stone gable-end chimneys
- Openings - south elevation window and door openings; period window and door openings at north elevation; attic windows at east elevation of main block
- Projections - beehive bake oven at west elevation of original 1-story kitchen block (missing); pent roof at south elevation of main block
- Trim and Secondary Features - wood cornices and rakeboards; shutters at first-floor windows
- Materials - ridge-pointed, random fieldstone masonry walls
- Craft Details - inscribed initial and date stones at southwest corner; ridge pointing at stone masonry
- Individual Interior Spaces - original floor plan including the kitchen with cooking fireplace, front and rear parlors in main block with corner fireplaces, and the second floor chambers with a corner fireplace in south room
- Related Spaces and Sequence of Spaces - level changes between kitchen and main block

- Interior Features – winder stairs at main block; wood trim including existing period chair rail and window sills at south parlor of main block
- Surface Finishes and Materials – plaster walls and ceilings; exposed ceiling joists and wood flooring above at kitchen and second floor spaces; rounded plaster jambs at period window openings; random-width wood floorboards

1790-1830.

The 1790-1830 period encompasses all of the major alterations and additions made to the building through Thomas Walker's tenure. An accurate restoration of the building to this period would require a significant degree of speculation especially concerning missing interior elements and finishes.



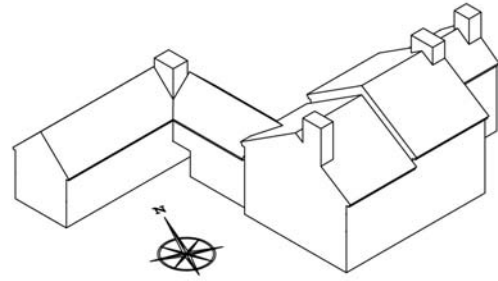
c. 1830

- Setting – open farm landscape; hillside orientation to south
- Shape – 2-story main block joined with full-width 2-story west block and east addition; detached springhouse/bakehouse
- Roof and Roof Features – gabled wood shingle roofs; multiple stone gable-end chimneys
- Openings – all period window and door openings with the exception of those added or modified as part of the 1926 renovations
- Projections – two beehive bake ovens at west façade of expanded west block; beehive bake oven at east façade of east addition; porch at south elevation of main block; porch at north elevation of east addition; pent roofs at south elevations of west block and east addition
- Trim and Secondary Features – wood cornices and rakeboards; shutters at first-floor windows
- Materials – stuccoed exterior masonry walls
- Individual Interior Spaces – amended floor plan at all levels including the “new Kitchen” with cooking fireplace in the east addition identified in Thomas Walker's 1835 will
- Related Spaces and Sequence of Spaces – level changes between blocks
- Interior Features – winder stairs at original kitchen block, main block, and east addition; wood trim including existing period chair rail and window sills at south parlor of main block and in the east addition kitchen
- Surface Finishes and Materials – plaster walls and ceilings; exposed joists and wood flooring at second-floor spaces; random-width wood floorboards



1926.

The 1926 period incorporates the 20<sup>th</sup>-century modifications and renovations made by the Ligget family and represents the last major construction campaign before the property was acquired by the Park.



c. 1926

- Setting - hillside orientation to south with landscape “improvements” including retaining wall between bakehouse and small barn and terrace at south side of springhouse/bakehouse
- Shape - entire amalgamated structure with L-shaped frame addition over north extension and springhouse/bakehouse
- Roof and Roof Features - gabled wood shingle roofs of various heights; multiple stone gable-end chimneys
- Openings - all existing openings including window openings added and modified at the north, east and west elevations
- Projections - porch at south elevation of main block; porch at north elevation of east addition; L-shaped porch at south and west elevations of north extension and springhouse/bakehouse; pent roofs at south elevations of west block and east addition; dormers at L-shaped frame addition over north extension and springhouse/bakehouse
- Trim and Secondary Features - wood cornices and rakeboards; shutters at first-floor windows
- Materials - stuccoed exterior masonry walls; wood clapboard siding at frame addition
- Individual Interior Spaces - revised and amended floor plan; all interior renovations including redesign of original kitchen as early 20<sup>th</sup>-century Colonial Revival dining room and the reinterpretation and renovation of the bakehouse
- Related Spaces and Sequence of Spaces - level changes between blocks
- Interior Features - early 20<sup>th</sup>-century Colonial Revival fireplace mantels; reproduction hardware
- Surface Finishes and Materials - plaster walls and ceilings with modifications to expose ceiling joists and wood flooring in selected spaces; replacement wood flooring

## **2.3 USE AND INTERPRETATION OF THE RESOURCE**



## 2.3 USE AND INTERPRETATION OF THE RESOURCE

Given the existing physical condition of the building, any future occupancy will require significant rehabilitation and restoration of the interior and exterior finishes as well as the reintroduction or upgrading of basic support utilities such as electrical service, heating and cooling, and plumbing. In addition, the impact of a proposed use on the historic resource must be considered in an effort to preserve the maximum amount of historic fabric. Several possible uses have been considered:

- Single-family Residence (See Figures 2.3a & 2.3b)

The building's size is very suitable for residential use and given that Stirling's Quarters was originally constructed as a residence, any type of single-family residential occupancy would be relatively low impact. Many of the amenities necessary for residential use, such as a kitchen and bathrooms, were introduced previously by the Ligget family in the 1920s. A new kitchen and bathrooms could be located in the areas already disturbed by the earlier work. As illustrated in the conceptual drawings, relocating partitions might also improve the functionality of the building.

As a single-family residence, Stirling's Quarters could be rented to a Park employee or to a private tenant. The income potential of a single-family residence is often limited.

There are no accessibility requirements for a single-family residence. Building code compliance issues are relatively minor and include:

Means of egress - Residential uses generally require two means of egress, one primary and one secondary. The straight run stair located in the 1926 northwest addition (Room 107) could serve as the primary means of egress, if granted a variance for width and tread/riser dimensions. If the stair were rebuilt at 36" in width, a variance would only be required for the risers.

The secondary means of egress could be provided through existing windows although they do not meet the current code requirement of 5.7 square feet of area and would also require a variance. Variances such as these are often granted for existing historic structures. An alternative would be to request a variance for the winder stairs to serve as the secondary means of egress.

An automatic sprinkler system would not be required in a single-family residential use. However, installation of a 13R system would compensate for the noncompliant stair and would eliminate the requirement for a secondary means of egress.

Noncompliant conditions - Other features, such as door widths, ceiling heights, and hallway widths which do not meet code, are generally permitted based on the existing and historic status of the structure.

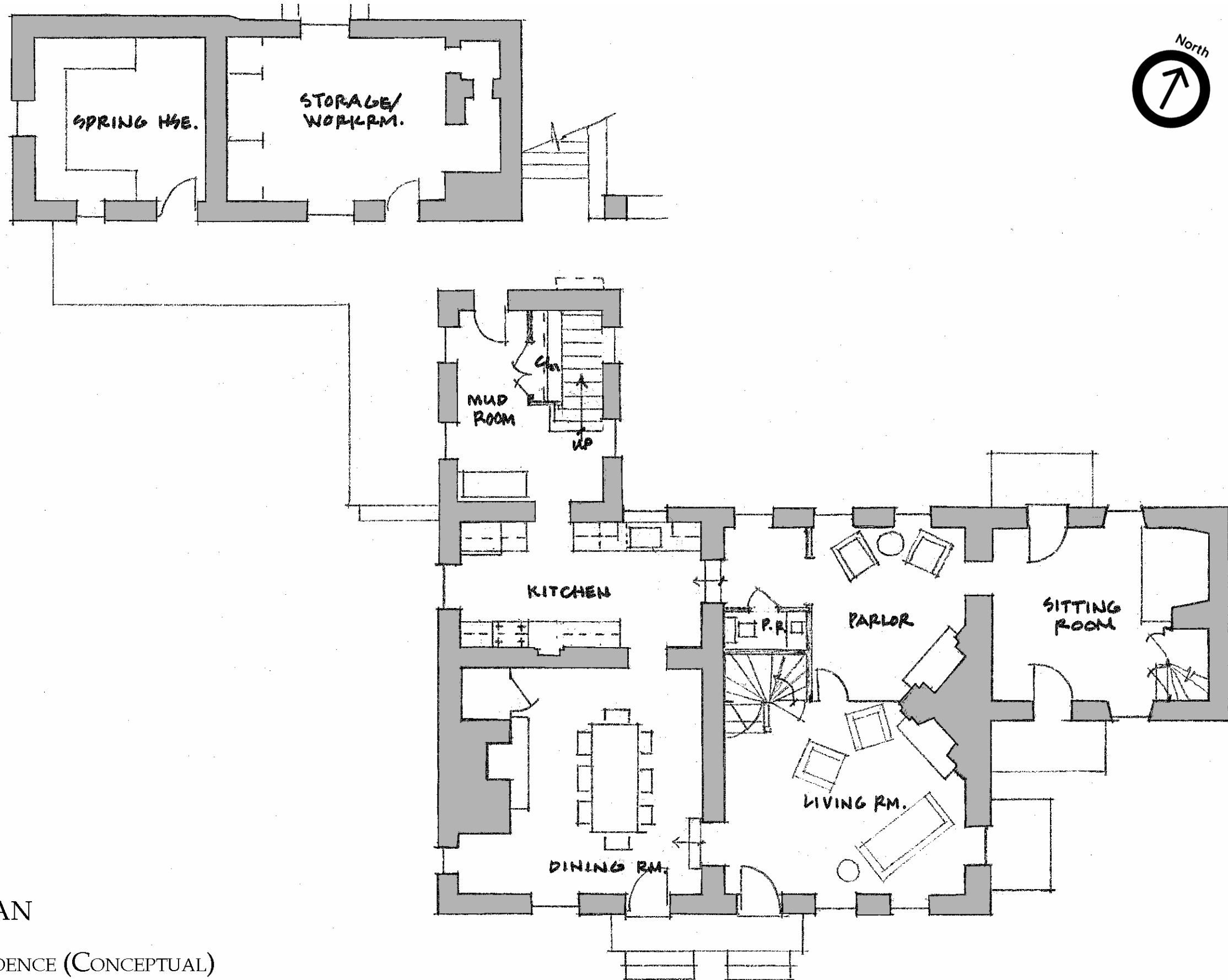


FIGURE 2.3A  
FIRST FLOOR PLAN  
SCALE: 1/8" = 1'-0"  
SINGLE-FAMILY RESIDENCE (CONCEPTUAL)

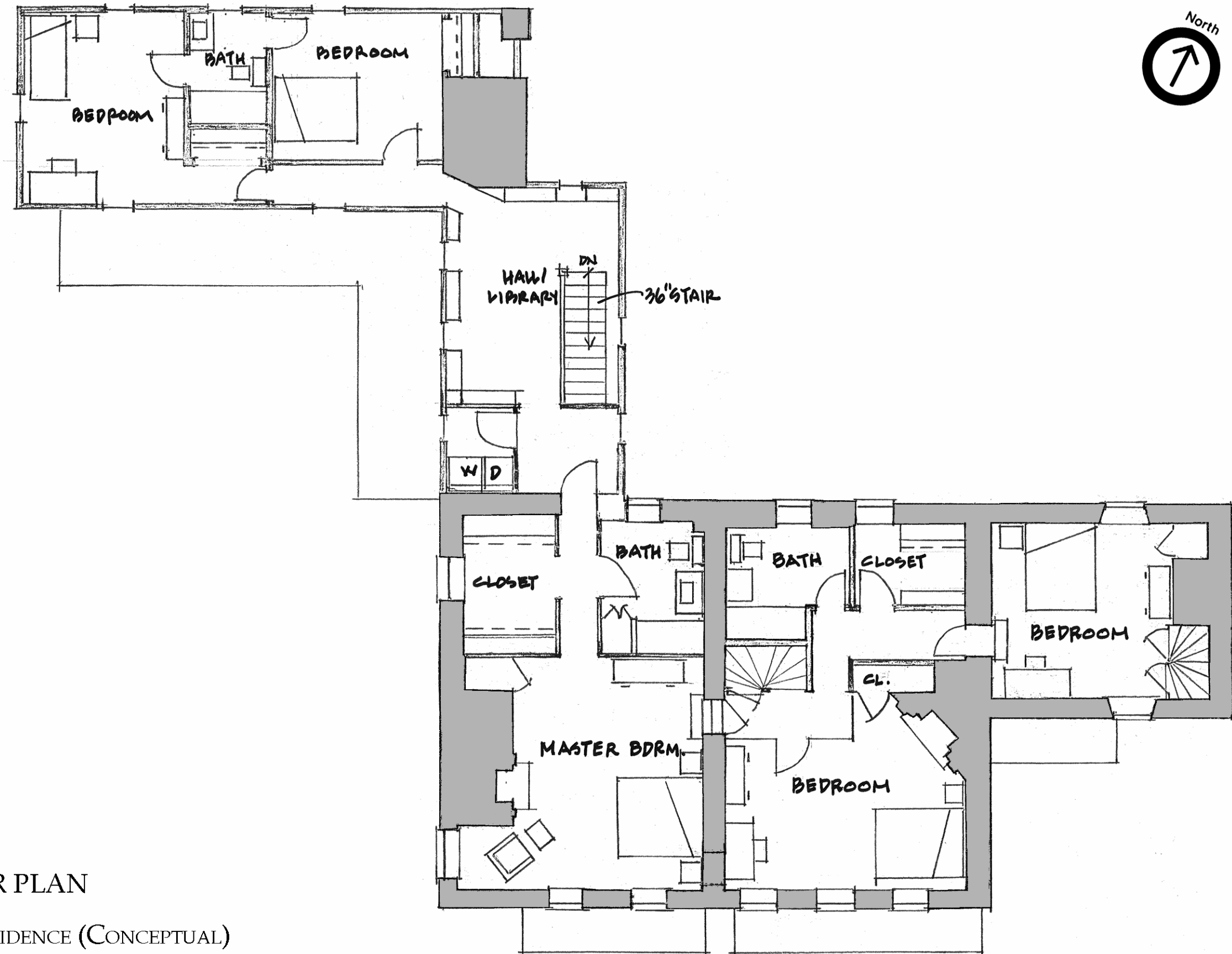


FIGURE 2.3B  
SECOND FLOOR PLAN  
SCALE: 1/8" = 1'-0"  
SINGLE-FAMILY RESIDENCE (CONCEPTUAL)



- Restaurant

Adapting Stirling's Quarters as a restaurant would require the installation of commercial cooking equipment which would introduce an undesirable fire hazard to the historic resource. The amount of space required for the kitchen, food preparation, clean-up, pantry and cold food storage, etc., is substantial and would occupy much of the building's square footage drastically reducing available dining area. Additional complications include accessibility issues and egress requirements if the second floor was to accommodate dining patrons. The space limitations of the building combined with the specific requirements of a restaurant ultimately make a commercial restaurant use infeasible for this building.

- Bed and Breakfast Lodging (See Figures 2.3c & 2.3d)

A Bed and Breakfast is another possible use for Stirling's Quarters. Once again, however, the small size of the building limits the number of possible guest rooms. Recent information from a hospitality consultant indicates that a financially successful Bed & Breakfast operation requires at least twelve (12) guest rooms. As the attached conceptual plans show, only four (4) guest rooms can reasonably fit within the building. Furthermore, each guest room needs a private or semi-private bathroom which would involve fairly invasive remodeling. Living quarters would also be required for the on-site operator.

Code and accessibility compliance issues include:

Primary and secondary means of egress - Similar to a single-family residence, a primary and secondary means of egress are required. The primary means of egress would utilize the straight run stair located in the 1926 northwest addition. Ideally, the stair would be re-constructed to a 36" minimum width with deeper treads. A variance would still be required for the riser height which is slightly more than the dimension allowed by code.

The guest room windows could serve as the secondary means of egress if granted a variance for size. Installation of an automatic fire suppression system throughout the building would permit a single, primary means of egress.

Accessibility - The International Building Code states that a transient lodging occupancy, such as a Bed and Breakfast, that contains "not more than five sleeping units for rent or hire that are also occupied as the residence of the proprietor are not required to be accessible." Although not required, an accessible guest room could be provided in a grade-level guest suite on the east end of the building. Due to interior level changes, however, a mobility-impaired guest would have to go outside the building to join the other guests in the dining room or room-service would have to be provided.

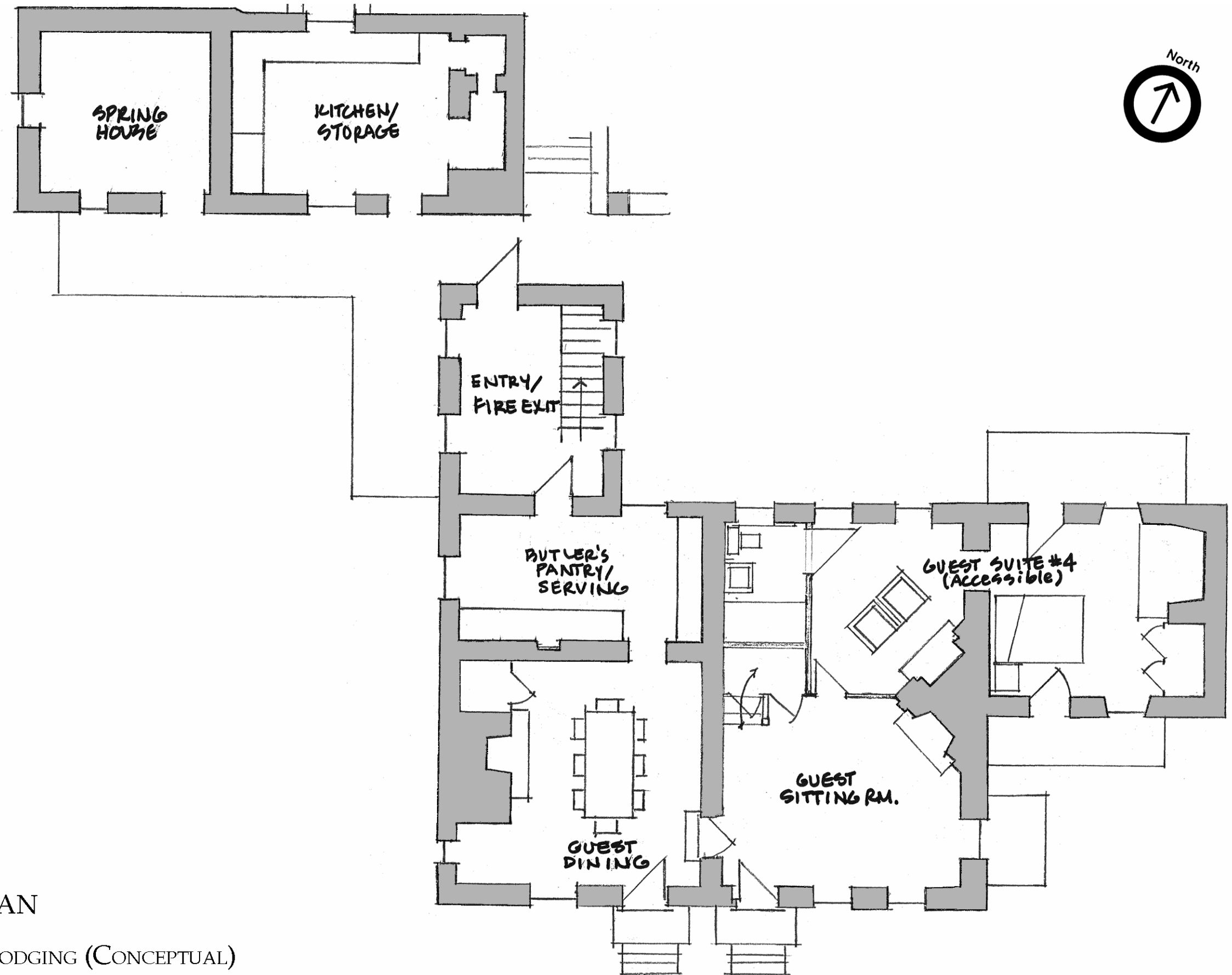


FIGURE 2.3C  
FIRST FLOOR PLAN  
SCALE: 1/8" = 1'-0"  
BED & BREAKFAST LODGING (CONCEPTUAL)

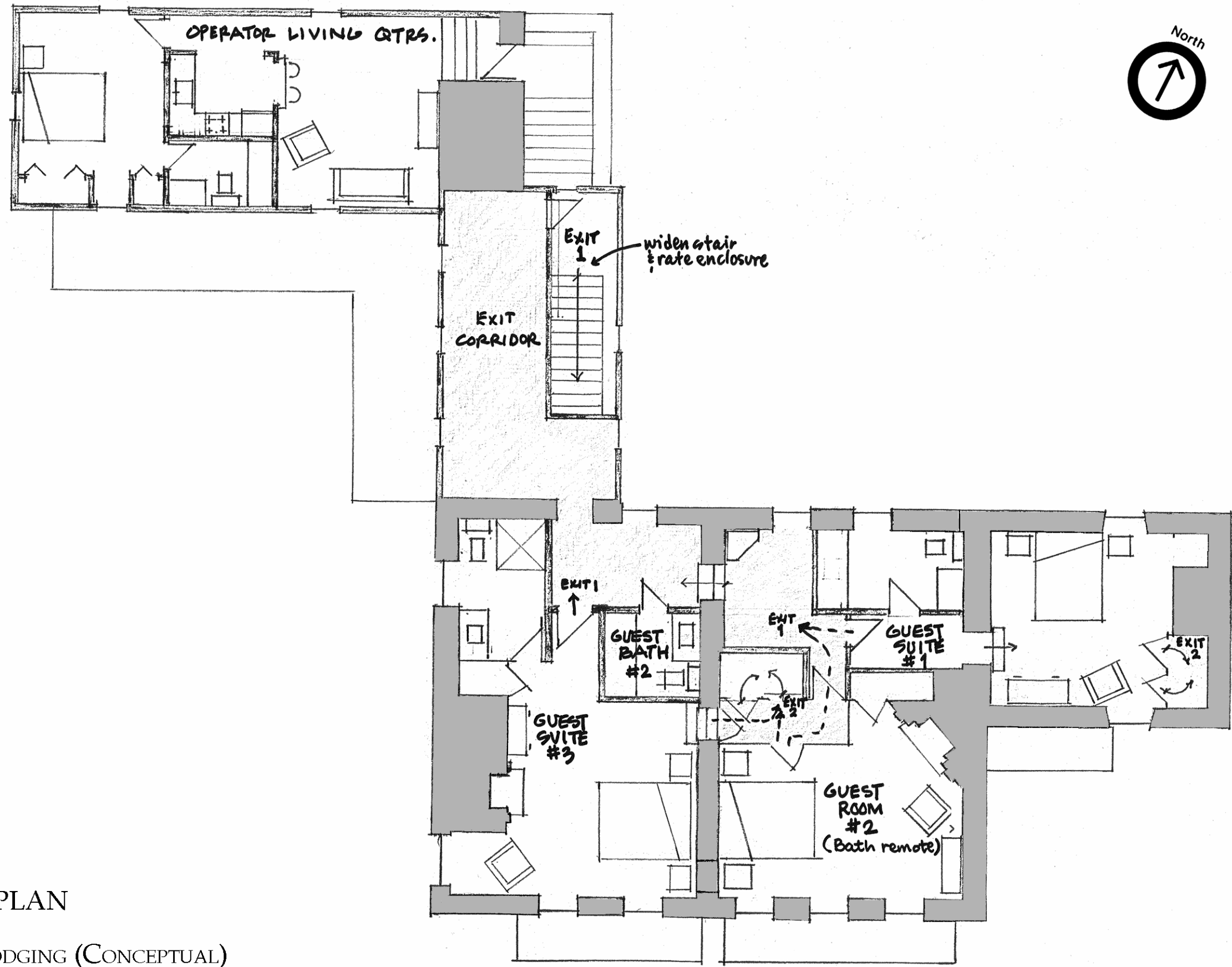


FIGURE 2.3D  
SECOND FLOOR PLAN  
SCALE: 1/8" = 1'-0"  
BED & BREAKFAST LODGING (CONCEPTUAL)

- Visitor Center/House Museum -

Since the building is located on the western edge of the Park, it could be adapted to serve as a satellite visitor and interpretation center. With future plans for a trailhead just across the street, Stirling's Quarters could also provide visitor support services such as restrooms and general Park and trail information.

This function would require staffing the facility with Park personnel. This use is unlikely to generate much income for the Park and, in fact, would probably add to the operating budget.

It may also be possible to utilize part of the building for visitor support services, such as restrooms, in conjunction with another, income-producing use, such as offices (see below).

- Offices or Business (See Figures 2.3e & 2.3f)

Stirling's Quarters could accommodate a variety of commercial functions including Park or tenant office space or even a small business such as an antiques store. As tenant office space, the structure could be adapted to be leased by one or multiple tenants.

The office or business reuse scenario is also relatively low impact. It is generally adaptable to existing room and spatial configurations, requires little reorganization of the existing layout, and in most cases would involve no special added amenities. The attached conceptual floor plans indicate the addition of powder rooms on the first and second floors of the building for tenant convenience. They could, however, be centralized in the bake house area and also be available to the public.

The site impact of car traffic in and out of the small parking area would also need to be addressed.

Code and accessibility compliance issues are greater with a commercial-type usage and include:

Number of Exits: In general, two (2) exits are required from each floor. Waivers will be required in order to meet the egress requirements. The c. 1926 straight run stair can be widened and enclosed to serve as one means of egress. The north and west ends of the building can utilize the short run of steps on the east gable end as the second means of egress. The main block and east end of the building will have to utilize the existing, original winder stairs as the second means of egress which, again, will require a variance.

Noncompliant conditions - Other features, such as ceiling heights and hallway widths which do not meet code, are generally permitted based on the existing and historic status of the structure.

Accessibility - As a building serving the public, an office or business use would require handicap accessibility to the site and the building.

Grade-level access into the building is possible from the two northern doors if one was widened and the other had a walkway installed to access the door. Movement within the building would still be limited due to the level change between the main block and the west wing.

Many of the doors and doorways would have to be widened to meet ADAAG guidelines. Doors which are very close to the required 32" clear width might remain in an effort to preserve the period doors and trim. Extremely narrow doors, however, would have to be altered.



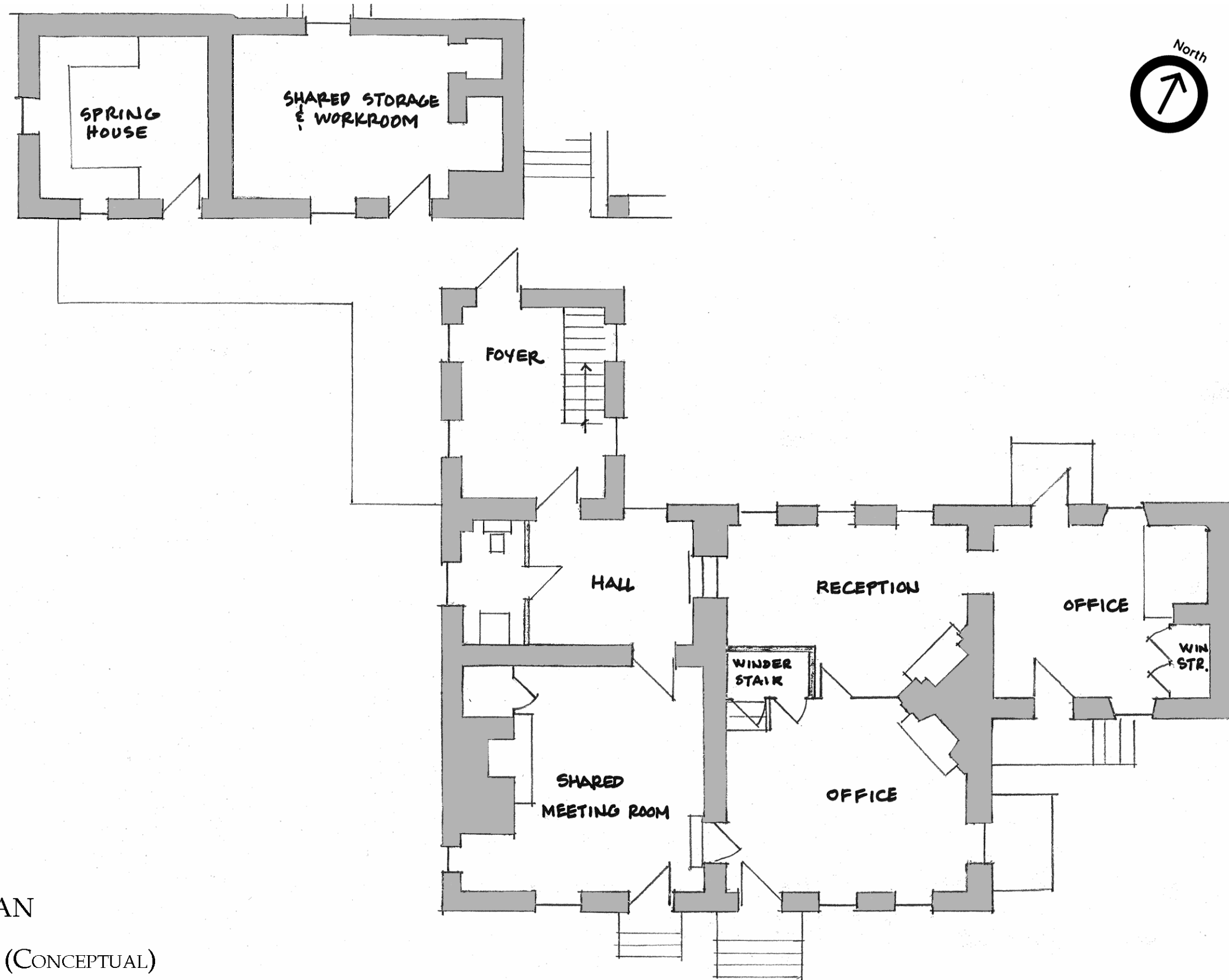


FIGURE 2.3E  
FIRST FLOOR PLAN  
SCALE: 1/8" = 1'-0"  
OFFICES OR BUSINESS (CONCEPTUAL)

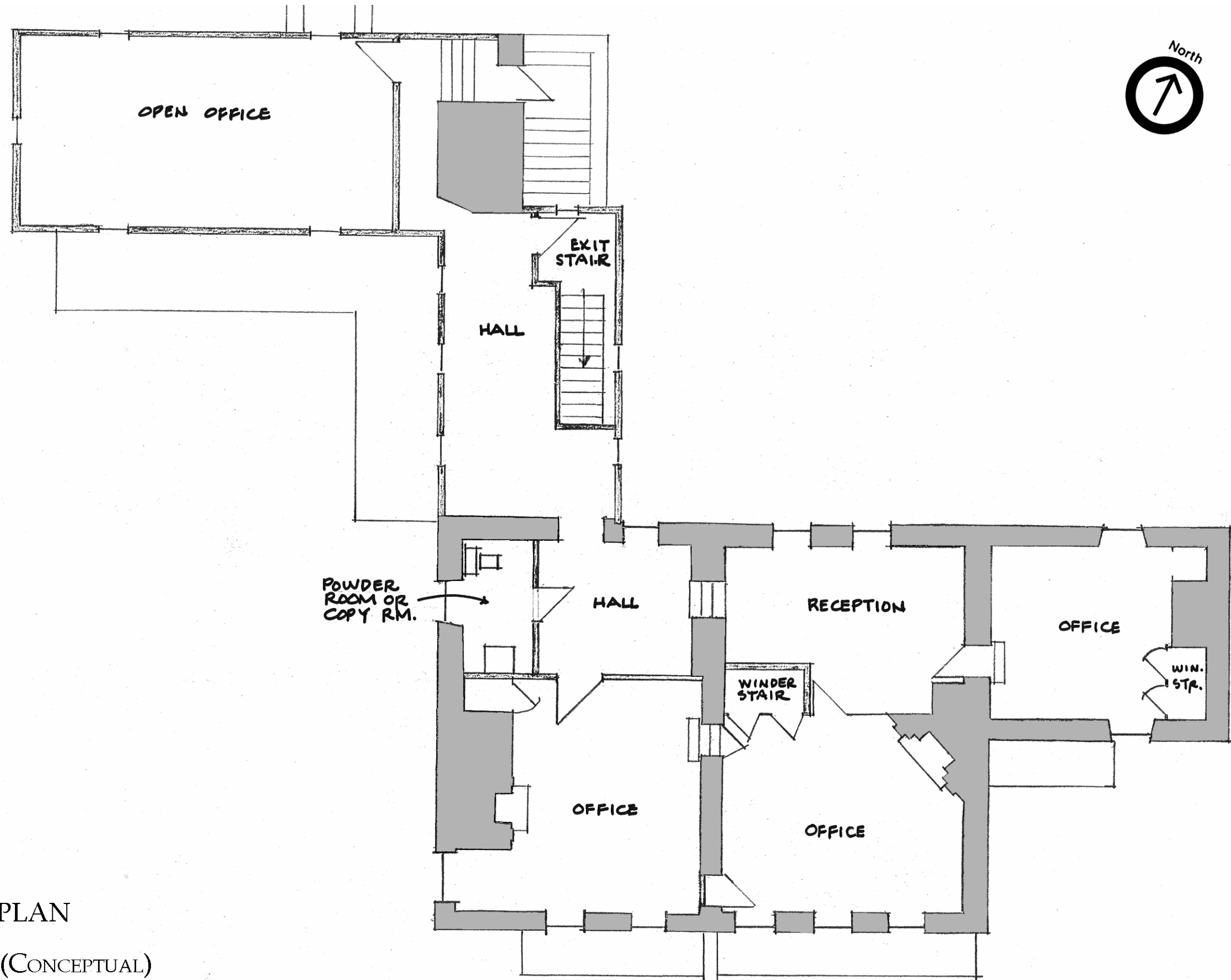


FIGURE 2.3F  
SECOND FLOOR PLAN  
SCALE: 1/8" = 1'-0"  
OFFICES OR BUSINESS (CONCEPTUAL)

## 2.4 CODE REVIEW



## 2.4 CODE REVIEW

In order to re-occupy Stirling's Quarters, the building will have to meet minimum life safety and fire safety criteria. In addition, accessibility for the physically disabled must be accommodated for any commercial or public service use.

Applicable codes include the following:

- International Building Code, 2003 for construction and building.
- International Existing Building Code, 2003 for construction and building.
- NFPA 101 Life Safety Code, 2003 for fire safety and means of egress
- NFPA 914 Code for Fire Protection of Historic Structures, 2001 for fire safety and means of egress (slated for revision Fall 2005)
- NFPA 909 Code for the Protection of Cultural Resources Properties - Museums, Libraries, and Places of Worship, 2003 (may apply depending on use & interpretation of structure)
- Americans with Disabilities Act of 1990 and Americans with Disabilities Act Accessibility Guidelines (ADAAG)

All of the above-listed codes or regulations acknowledge that there are challenges in meeting all of the requirements in historic buildings without damaging or losing significant historic fabric. In most cases, alternative methods of compliance or variances must be reviewed and agreed upon by a design process team. The following is a summary of the most significant code elements associated with the existing physical design of Stirling's Quarters and a general discussion of the new requirements relative to the various possible uses discussed above.

### Existing Building Components

The most significant existing physical components of Stirling's Quarters are summarized below followed by a general discussion of the code requirements relative to possible future uses.

Existing Occupancy Group: Previously Dormitory (unoccupied for approx. 5 years)

Proposed Occupancy Groups: Business; or Mixed Business & Assembly; or Lodging; or One- and Two-Family Residential

Business is a relatively lenient usage classification.

Assembly is a relatively restrictive usage classification.

Lodging is used for short-term residential occupancies such as a "Bed and Breakfast" and would require installation of a fire protection system (i.e., sprinklers).

One-family Residential is a relatively lenient usage classification.

Construction Type: Mixed; Type III B (masonry exterior walls and bearing walls with wood framed interior walls, floors and roof) and Type V B (common construction). The 1926 additions are Type V; all other sections are Type III. Protection type is "B"

(unprotected). However, the codes allow for some fire rating qualities to be applied to such materials as plaster on walls.

Total Gross Square Footage: Floor area is 7,105 square feet and includes the basements and the accessible attics.

Total Occupiable Space: 4,625 SF (first and second floors only)

Height and Number of Stories: Existing feet and three stories. The main block attic must be considered a "story" since it is accessible by a stair and a person can stand up in the space.

Stairs: Four (4) existing stairs; 2 winder stairs and 2 straight runs.

### **NFPA 101 & NFPA 914**

NFPA 914, Chapter 4, outlines the process by which the historic integrity of an historic structure and the existing fire safety features shall be assessed. Section 4.3.3.1.2 states that "Buildings shall be evaluated in accordance with the requirements of NFPA 101, Life Safety Code." Structures that are found to have deficiencies shall have a plan of correction developed to achieve either prescriptive compliance or performance-based compliance. Prescriptive compliance may include alternatives, equivalencies, and/or modifications. Such compensatory features may include automatic fire suppression, fire-rated walls and doors to contain fire and smoke, and alarm monitoring to decrease response time.

Number of Exits: In general, two (2) exits are required from each floor. A single means of egress is allowed if (a) the single exit serves only one floor and the total travel distance is less than 100' or (b) there is only one (1) tenant, the building has automatic fire suppression and the total travel distance is less than 100'.

Conditions: The first floor has five (5) doors that exit the building. The second floor has four stairs (see below) which would require waivers to retain. Until a use is selected, it is difficult to determine if the building meets the criteria for a single means of egress.

Exit Enclosures: 1-hr. rated if three stories or less including fire-rated door w/closer.

Conditions: Current stairs are either not enclosed or the enclosure is not 1-hr. rated. Adding automatic fire suppression to the building may be an alternative to this requirement at the east winder stair. The board wall surrounding the main block winder stair is plastered on one side for the full height and partially plastered on the interior. It may be possible to show that the historic materials are close to providing the necessary rating. The straight run stair is not enclosed.

Headroom in existing buildings: 84", ceiling projections 80".

Conditions: Room 107 has only an 82" ceiling. There is no way to alter this without significant structural revisions. Rooms 209 - 214 have ceilings which slope down to 72". The area of the sloped ceiling exceeds the allowable area by code.

Doors: Exit enclosure doors must swing in the direction of egress.

Conditions: All existing exterior doors swing inward against the direction of egress.



Stairs: Existing building maximum riser 7½", minimum tread 10".

Conditions: Existing straight run stair in Room 107 does not meet code for existing stairs for any possible use. They are too narrow (27" wide), too steep (8½" riser, 9" tread) and do not have 80" of headroom at the bottom. Both existing winder stairs do not meet code definition for allowable winder stairs. The tread depth is only 3¾" at the point where it needs to be 7½". Short straight run stair in Room 211 meets the existing stair criteria but does not have the required handrails.

### **IBC & IEBC**

The IBC and the IEBC provide guidelines for the building height and area limitations depending on the occupancy.

The height limitation for Type III B is 3 stories and for Type V B the limit is 2 stories. Unless a separation is introduced into the building, the more stringent limitation of 2 stories must apply to Stirling's Quarters. Since the main block attic is an occupiable space (regardless of stated intentions to not occupy the attic) a waiver must be requested or a fire separation will have to be established between the 1926 Type V B construction and the other, Type III B sections in which case each section would comply with the respective height limitations.

The building area limitation for Type III B is 18,000 SF and for Type V B the limit is 9,000 SF. The IEBC allows for an additional 20% building area for historic buildings. Stirling's Quarters is below all of the noted limitations for any possible use.

### **ADAAG**

In general, historic structures are expected to comply with the accessibility guidelines for building alterations except where the required work would threaten or destroy the historic significance of the building. In such cases the alternative requirements in ADAAG may be used. The determination of whether or not an alteration would threaten or destroy historic significance is made by the State Historic Preservation Office (SHPO), for projects subject to Section 106 review, or the Advisory Council on Historic Preservation. For buildings not subject to Section 106 review, the entity undertaking the alterations must still consult with the SHPO.

Minimum ADAAG requirements for historic preservation are:

- At least one accessible route from a site access point to an accessible entrance.
- At least one accessible entrance which is used by the public.
- At least one toilet facility along an accessible route (may be unisex).
- Accessible routes from accessible entrance to all publicly used spaces on at least the level of the accessible entrance (includes 32" clear doorways).

Stirling's Quarters presents several existing conditions that are in conflict with even the minimum requirements.

Site Access: Existing loose gravel parking lot is not accessible. Stone porch floors are accessible. Raised porches and stoops (to be restored) are not accessible.

Accessible Entrance: There are two existing grade-level doors on the north side of the building. The east door has no landing or walkway to access the door. It is, however, 35" wide which exceeds the minimum requirement. This door would provide access into the east addition and the main block. The west door is only 30" wide and located in a deep jamb. The door is not wide enough for access, nor does it have the necessary clearance at the latch side of the door to operate the hardware. Once inside this door, there is level access to the west wing.

Toilet Facilities: Only one ground-floor powder room exists and it is not accessible. Any new toilet facilities would need to be accessible.

Accessible Route: Once inside the building there are several impediments to accessibility including a level change between the main block and the west wing of 16½". The doorways between all of the rooms are less than the required 32". All but one of the doorways are set in masonry walls and the door that is in a wood partition wall dates from 1769.

## 2.5 TREATMENT PRIORITIES



## 2.5 TREATMENT PRIORITIES

Priority 1 treatments for Stirling's Quarters include those elements forming the building envelope and protecting the interior elements from active deterioration. The roof, which was in very poor condition, was recently replaced in the spring of 2005. The other high priority items are:

- Restore all exterior windows and frames.
- Restore all exterior doors and frames.

Priority 2 items are those that will make the interior of the building structurally safe to enter and include:

- Repoint chimneys and other façade areas.
- Reinforce roof framing.
- Replace and repair damaged first-floor framing.
- Install plywood or flooring for safe building access.

Priority 3 items are finishes and other aesthetic features that need to be repaired as part of the building's overall preservation and reuse:

- Restore exterior cornices and rake boards.
- Restore exterior pent roofs and porches.
- Replace missing finish flooring.
- Restore plaster wall and ceiling finishes.
- Restore/replace wood baseboard.
- Restore interior doors, trim, and hardware.
- Restore exterior stucco and/or repoint exposed stone wall.

**2.6 ROOM/FEATURE  
TREATMENT  
RECOMMENDATIONS**





## 2.6 ROOM/ FEATURE TREATMENT RECOMMENDATIONS

Except for a few of the rooms constructed as part of the c. 1926 renovations, none of the interior spaces of Stirling's Quarters contain all of their original construction period fabric and features. Some rooms, however, retain more of the overall character of the original space and should be preserved to a higher degree. In general, if modifications have to be made to accommodate the new use, the more recent, 1926-present materials and spaces, should be compromised in order to preserve the maximum amount of 18<sup>th</sup>- and 19<sup>th</sup>-century features. For reference, the dates of the room finishes are summarized before the list of recommended work. More detailed discussions of the specific features are included in Part 1.3 Physical Description.

### EXTERIOR ELEVATIONS -

#### South Façades -

Recommendations:

- Reconstruct pent roof at west wing and main block
- Reconstruct west wing stoop and steps using stone
- Reconstruct stoop and steps on main block using stone
- Reconstruct east addition stoop and steps
- Lower grade to clear basement window sills and slope away from building
- Repair deteriorated existing porch roof framing and posts
- Reset and repoint loose paving stones
- Remove all deteriorated stucco from façade
- Repoint masonry
- Restucco façade with thin coat of lime-based stucco to match c. 1830 finish
- Restore all windows
- Reconstruct shutters
- Repair deteriorated wood siding, corner boards and cornices
- Paint all previously painted surfaces including windows, doors, shutters, cornices, siding, and porch elements

#### West Façades -

Recommendations:

- Remove all deteriorated stucco from façade
- Repoint masonry
- Restucco façade with thin coat of lime-based stucco to match c. 1830 finish

- Restore all windows
- Reconstruct shutters
- Repair deteriorated siding
- Repair deteriorated existing porch roof framing and posts
- Paint all previously painted surfaces including windows, shutters, cornices, siding, and porch elements

#### **North Façades -**

##### Recommendations:

- Reconstruct pent roof at east addition
- Remove all deteriorated stucco from façade
- Repoint masonry
- Restucco façade with thin coat of lime-based stucco to match c. 1830 finish
- Restore all windows
- Reconstruct shutters
- Repair deteriorated siding
- Paint all previously painted surfaces including windows, shutters, cornices, siding, and porch elements

#### **East Façades -**

##### Recommendations:

- Remove all deteriorated stucco from façade
- Repoint masonry
- Restucco façade with thin coat of lime-based stucco to match c. 1830 finish
- Restore all windows
- Reconstruct shutters
- Repair deteriorated siding
- Paint all previously painted surfaces including windows, shutters, cornices, siding, and porch elements

## **INTERIOR SPACES -**

### **Room 001 & Room 002 -**

Existing finishes/features:

- c. 2000 - concrete floor slab
- 1926 - cellar doors & upper cheek walls, interior stair well
- 1769 - masonry walls, window openings

Recommendations:

- Restore windows
- Repair cellar doors

### **Room 101 -**

Existing finishes/features:

- 1926 - floor boards and subfloor (mostly missing), top plaster, baseboards (mostly missing), ceiling joists
- c. 1830 - window frames, trim, exterior doors, fireplace and mantel, winder stair, base plaster (now covered)

Recommendations:

- Repair or replace structural floor joists
- Clean & patch plaster walls
- Reinstall plaster ceiling
- Install new wood floor and baseboards
- Restore/repair windows
- Restore/repair all doors
- Repaint all previously painted surfaces

### **Room 102 -**

Existing finishes/features:

- 1926 - top plaster, west window, board wall plaster, fireplace mantel, top floor boards (missing)
- 1769 - stair surround boards, ceiling joists, center and east window frames

Recommendations:

- Repair or replace structural floor joists
- Patch plaster walls
- Reinstall plaster ceiling

- Install new wood floor and baseboards
- Restore/repair all windows; 1926 window to remain
- Retain 1926 mantel
- Repaint all previously painted surfaces

**Room 103 -**

Existing finishes/features:

1926 - top floor boards, mantel, top plaster, baseboard, south door, east window & frame, ceiling joists - 1926

1769 - winder stair, north doors & trim, south window frames, south door frame, west door & frame, majority of chair rail, base plaster

Recommendations:

- Patch plaster walls
- Reinstall plaster ceiling
- Retain 1926 wood floor and baseboards
- Restore/repair all windows; 1926 window to remain
- Restore/repair south door; 1926 door to remain
- Retain 1926 mantel
- Repaint all previously painted surfaces
- Retain 1769 winder stair
- Retain or reconstruct stair railing

**Room 104 -**

Existing finishes/features:

1769 - floor joists, south door frame & window, north window

1926 - top plaster, mantel, fireplace closet & hearth, powder room, backband trim at east door

Recommendations:

- Replace structural floor joists
- Patch plaster walls
- Install new wood floor and baseboard
- Exposed ceiling joists to remain
- Remove 1926 powder room
- Patch & repair plaster walls

- Retain 1926 fireplace and hearth; preserve evidence of large cooking fireplace

**Room 105 -**

Existing finishes/features:

1926 - tile wainscot, top plaster, bathroom fixtures, west casement window

1769 & c. 1810 - base plaster

Recommendations:

- Preserve winder stair evidence at masonry walls
- Remove powder room in its entirety including all 1926 finishes

**Room 106 -**

Existing finishes/features:

1926 - top plaster surface & ceiling, west window & frame, basement stair/areaway

c. 1810 - north window & frame, possibly north doorway, base plaster

1769 - south window frame

Recommendations:

- Install new structural floor joists
- Install new wood flooring and baseboards
- Patch & repair plaster walls and ceiling
- Repair/restore both windows
- Retain areaway as possible stair to basement

**Room 107 -**

Existing finishes/features:

1926 - all finishes

c. 1810 - south masonry wall

Recommendations:

- Install new structural floor joists
- Install new wood flooring and baseboards
- Patch & repair plaster walls and ceiling
- Repair/restore all windows
- Repair or replace existing north door
- Repair existing stairs to second floor and reconstruct railing



**Room 108 -**

Recommendations:

- Patch plaster walls and ceiling
- Brick floor to remain

**Room 109 -**

Existing finishes/features:

1926 - west window, ceiling joists

18<sup>th</sup> century - general configuration of the room, brick floor

Recommendations:

- Repair plaster ceiling
- Repoint deteriorated areas of interior stone wall

**Room 201 -**

Existing finishes/features:

1926 - top plaster surface, door hardware, baseboards

c. 1830 - base plaster layer, ceiling joists

Recommendations:

- Clean & patch plaster walls
- Reinstall plaster ceiling
- Retain existing wood floor
- Install new baseboard
- Restore/repair windows
- Restore/repair all doors
- Repaint all previously painted surfaces

**Room 202, 203 and 204A -**

Existing finishes/features:

1926-1970s - board wall forming hallway, floorboards, cedar closet, bathroom, top plaster surface, west window & frame

1769 - east window & frame, winder stair wall boards

Recommendations:

- Retain floor & patch in area of bathroom
- Restore both windows

- New baseboard
- Remove bathroom, cedar closet and wall partitions
- Patch plaster (extensive in bathroom)
- Replace existing plaster ceiling
- Restore for reuse doorway to 1810 section
- Repaint all previously painted surfaces

**Rooms 204B and 205 -**

Existing finishes/features:

1926 - closet and board wall, mantel, ceiling joists, top plaster surface, flooring, baseboards

1810 - door & doorway into west side

1769 - window frames, chair rail

Recommendations:

- Retain floor
- Retain mantel
- Repair chair rail on east wall
- Install ceiling
- Remove board wall & closet
- Retain west doorways
- Restore winder stair & doors

**Rooms 206, 207 and 208 -**

Existing finishes/features:

1926 - flooring, top plaster surface, fireplace, mantel & closet, north partition wall, bathroom, built-ins, west windows, flooring, north doorway into 1926 addition

1810 - south window frames, south doorway

Recommendations:

- Retain flooring & patch in bathroom.
- Retain board partition location. Restore missing boards after bathroom removal
- Retain all windows & repair
- Remove bathroom fixtures and finishes
- Remove ceilings in north areas
- Retain fireplace

- Repair & patch plaster

#### **Rooms 209 - 214 -**

Existing finishes/features:

1970s - bathroom fixtures and finishes

1926 - all other finishes

Recommendations:

- Retain wood flooring, patch in areas of bathroom removals
- Patch plaster walls and ceilings
- Remove bathroom fixtures, finishes and partitions
- Remove bedroom closets and partition walls
- Repair/restore wood windows
- Replace existing stair

#### **Room 301 -**

Existing finishes/features:

1926 - top layer of floorboards

c. 1830 - bottom layer of floorboards, window frame, rafters, winder stair

1769 - stucco on west wall

Recommendations:

- Retain all wood floorboards
- Repair/restore window, frame, sill and trim
- Retain existing stucco and plaster surfaces without additional patching or repairs.

#### **Room 302 -**

Existing finishes/features:

1926 - floorboards, window sash

1769 - railing, winder stair & enclosure, window frame

Recommendations:

- Retain all wood floorboards
- Repair/restore window sash and frame

**Room 303 -**

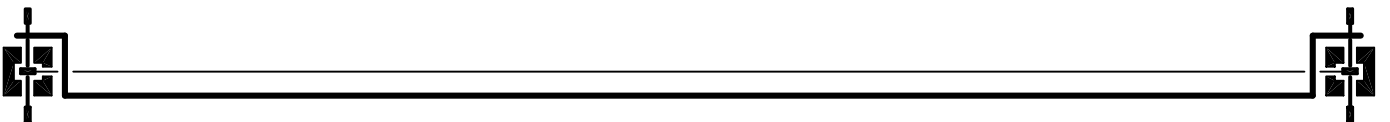
Existing finishes/features:

- 1926 - roof structure, window & frame, flooring infill, access hatch
- c. 1810 - floorboards, wall plaster

Recommendations:

- Retain all wood floorboards
- Repair/restore window, frame, sill and trim
- Retain existing stucco and plaster surfaces without additional patching or repairs

## BIBLIOGRAPHY





## BIBLIOGRAPHY

### PUBLISHED MATERIALS:

- Bertram, Michael. "Reverend William Currie, 1710-1803: Aspects of his Life." *Tredyffrin-Easttown History Club Quarterly*, Vol. 42, No. 2 (Spring 2005), pp. 49-65.
- Bodle, Wayne K. *The Valley Forge Winter: Civilians and Soldiers in War*. University Park, PA: The Pennsylvania State University Press, 2002.
- Bodle, Wayne K., and Jacqueline Thibaut. *Valley Forge Historical Research Report*. 3 volumes. Valley Forge, PA: U. S. Department of the Interior, National Park Service, Valley Forge National Historical Park, 1980.
- Duer, William Alexander. *Life of William Alexander, Earl of Stirling, Major-General in the Army of the United States during the Revolution: with selections from his correspondence*. New York: Wiley & Putnam, 1847.
- Futhey, John Smith, and Gilbert Cope. *History of Chester County Pennsylvania with Genealogical and Biographical Sketches*. Philadelphia: L. H. Everts, 1881.
- "Happy Spirits Inhabit Old Valley Forge Home." *Today's Post*. Vol. 2, No. 149 (Monday, July 31, 1972).
- Headley, J. T. *Washington and His Generals*. New York: Charles Scribner, 1852.
- Heathcote, Charles William. "General Stirling - Devoted Patriot." *The Picket Post* (April 1954), pp. 39-44.
- Liggett, Mrs. Robert C. "History of General Lord Stirling's Quarters and the Property Now Known as Echo Valley Farms, Valley Forge." *Tredyffrin-Easttown History Club Quarterly*, Vol. 10, No. 2 (1958), pp. 39-41.
- Liggett, Mrs. Robert C. "William Currie, 1710-1803." *Tredyffrin-Easttown History Club Quarterly*, Vol. 10, No. 2 (1958), pp. 41-42.
- MacNeil, Henry T., and Aimee Junker MacNeil. *Valley Forge Landmarks*. Whitford, PA: Stephen Moylan Press, 1958.
- Nelson, Paul David. *William Alexander, Lord Stirling*. Tuscaloosa, AL: The University of Alabama Press, 1987.
- The Pennsylvania Gazette, 1720-1800*, Accessible Archives Inc. [database online] [cited 20 December 2004].
- Pinkowski, Edward. *Washington's Officers Slept Here: Historic Homes of Valley Forge and Its Neighborhood*. Philadelphia: Sunshine Press, 1953.
- Pleasants, Henry. *The History of Old St. David's Church, Radnor, Delaware County, Pennsylvania*. Philadelphia: The John C. Winston Co., 1915.
- Quimby, Alden W. *Valley Forge, A Tale*. New York: Eaton & Mains, 1906.
- Smith, Paul H., et al., eds. *Letters of Delegates to Congress, 1774-1789*, Vol. 8, September 18, 1777 - January 31, 1778 (Washington, DC: Library of Congress, 1976-2000).
- Taylor, David. "General William Alexander Lord Stirling." *The Picket Post* (May 1963), pp. 30-32.

Treese, Loretta. *Valley Forge: Making and Remaking a National Symbol*. University Park, PA: Pennsylvania State University Press, 1995.

United States Census Office. *Population Schedules of the First through Seventh Censuses of the United States, 1790-1850*. Washington, DC: National Archives and Records Service, 1949-1965. Microfilm.

Valentine, Alan Chester. *Lord Stirling*. New York: Oxford University Press, 1969.

Wildes, Harry Emerson. *Valley Forge*. New York: Macmillan, 1938.

Woodman, Henry. *The History of Valley Forge*. Oaks, PA: John Francis, Sr., 1922.

#### **MAPS & ATLASES:**

*Atlas of Chester Co., Pennsylvania*. Safe Harbor, Lancaster Co., PA: A. R. Witmer, 1873.

*Atlas of Properties on Main Line Pennsylvania Railroad from Devon to Downingtown and West Chester*. Philadelphia: A. H. Mueller, 1912.

*Breou's Official Series of Farm Maps, Chester County, Pennsylvania*. Philadelphia: W. H. Kirk & Co., 1883.

Klockhoff, H. *A Chorographical Map, of the Country, round Philadelphia*. c. 1780. Library of Congress Geography and Map Division, Washington, DC.  
[<http://hdl.loc.gov/loc.gmd/g3790.ar105200>] (April 5, 2005).

Davis-Armstrong-Sparks Map. Original at Cornell University Library. Copy at Valley Forge National Historical Park Archives, Valley Forge, PA.

Galloway Spy Map. Copy at Valley Forge National Historical Park Archives, Valley Forge, PA.

Parker Spy Map. "Plan of Washington's Position. Mr. Parker, Late, A Merchant in Virginia, Now in Philadelphia." Copy at Valley Forge National Historical Park Archives, Valley Forge, PA.

Pennypacker Map. Copy at Valley Forge National Historical Park Archives, Valley Forge, PA.

#### **UNPUBLISHED MATERIALS & MANUSCRIPTS:**

1798 U. S. Direct Tax (Glass Tax), Chester County, Tredyffrin Township. Microfilm. Chester County Historical Society, West Chester, PA.

Dodd, John B. "Classified Structure Field Inventory Report: Quarters of Major General William Alexander, Lord Stirling." September 1979. Valley Forge National Historical Park Library, Valley Forge, PA.

Currie, William, and Thomas Walker. "Memorandum Book of the Reverend William Currie (1710-1803) from 1782 to c.1800 and his grandson-in-law, Thomas Walker of Tredyffrin Township, from c.1805-1821 (1838)." Photocopy. Chester County

- Historical Society, West Chester, PA. Original document noted to be the property of St. David's Church, Radnor, PA.
- John Milner Associates, Inc. with Skidmore, Owings, and Merrill, LLP. "Archeological Investigations, Stirling's Quarters (VAFO-348), Valley Forge National Historical Park: Preliminary Field Results." June 28, 2004.
- Ligget, Frances H., ed. "Distant Drums."
- Ligget, Frances H., ed. "Great Valley Days." June 1965.
- Rhoads, Ann F., Douglas Ryan, and Ella W. Aderman. "Land Use Study of Valley Forge National Historical Park." March 1989. Valley Forge National Historical Park Library, Valley Forge, PA.
- Stacks, David C. National Register of Historic Places Nomination Form. "Major General Lord Stirling's Quarters (Chester County, Pennsylvania)." June 1973.
- Schooler, Alice Kent. Pennsylvania Historical and Museum Commission Register of Historic Sites and Landmarks Nomination Form. "Major General Lord Stirling's Quarters (Tredyffrin Township, Chester County)." October 1972.
- University of Pennsylvania, Historic Preservation Program. "Stirling's Headquarters: An Historic Structures Report Developed for Valley Forge National Park." May 1994.

**ARCHIVES & REPOSITORIES:**

- Chester County Archives and Records, West Chester, PA.
- Chester County Historical Society, West Chester, PA.
- Chester County Recorder of Deeds, West Chester, PA.
- Historical Society of Pennsylvania, Philadelphia, PA.
- St. David's (Radnor) Episcopal Church, Wayne, PA.
- Valley Forge National Historical Park Archives, Valley Forge, PA.
- Valley Forge National Historical Park Library, Valley Forge, PA.

## APPENDICES



**APPENDIX A**  
**BUILDING CHRONOLOGY**  
**DRAWINGS**





## APPENDIX A - BUILDING CHRONOLOGY DRAWINGS

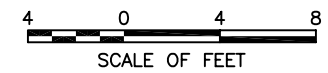
The Building Chronology drawings included in this Appendix are intended to represent the general development and evolution of the building from its original construction period, c. 1769, through the last extensive renovation campaign undertaken in 1926. The intermediate dates (1790, 1810, and 1830) are approximate; they were selected to roughly correspond to major construction periods that were identified and corroborated by archival research and field investigations.

Where specific architectural elements have since been removed or are currently missing, some conjecture was used to approximate their appearance based on existing conditions and informed by historical precedent. The drawings are not intended to be a literal representation of the building at any one period, but rather to illustrate the major changes to the form and appearance of the building through time.

Although the building was significantly expanded and reconfigured in 1926, it should be noted that all of the changes documented by the 1926 drawings included in this Appendix did not necessarily occur as part of the 1926 renovations. Undoubtedly, subtle and perhaps even significant alterations were made to the building during the nearly 100 years since the previous known construction campaign occurred circa 1830. All modifications made during the intervening years are subsequently included in the 1926 drawings. For example, it is not clear exactly when the bake ovens at the east and west elevations were dismantled, but archive photographs indicate that they had been removed sometime before c. 1900. These changes are, therefore, indicated in the 1926 drawings.



SOUTH ELEVATION - 1769



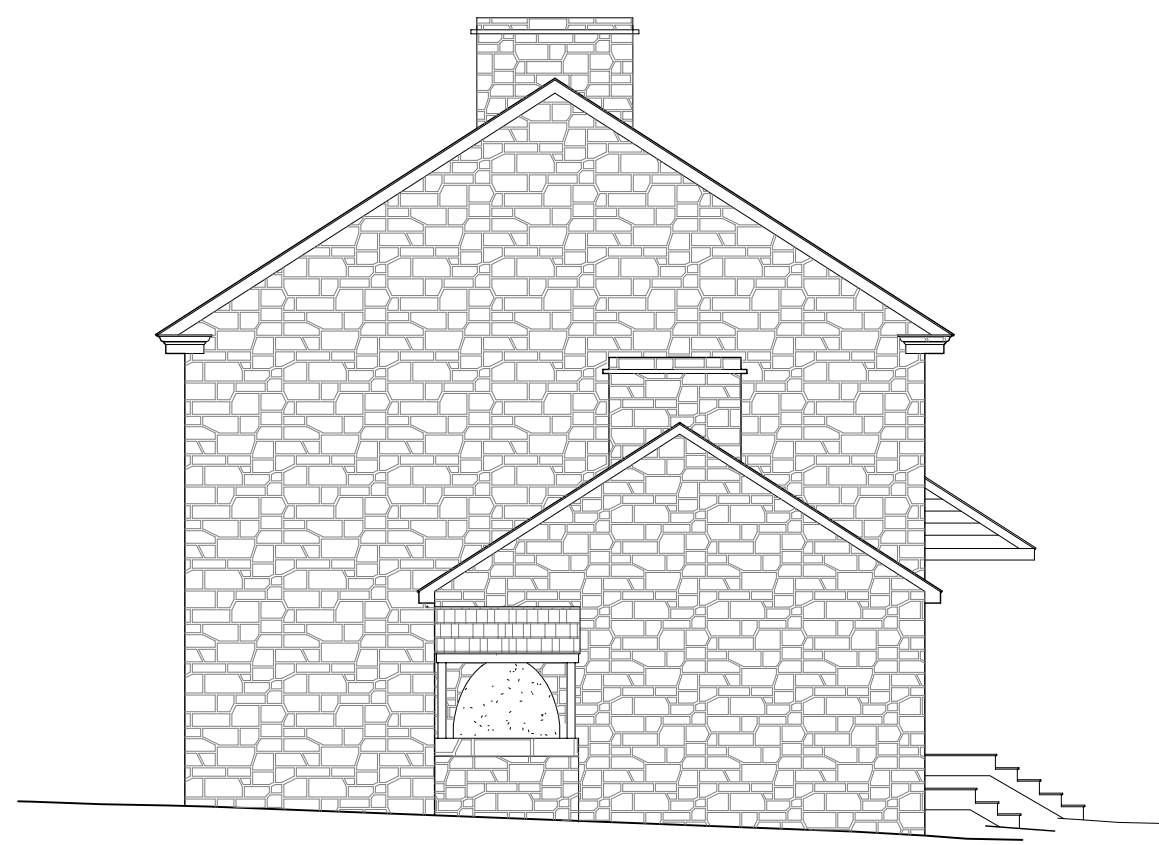
SCALE OF FEET

Historic Structure Report  
**STIRLING'S QUARTERS**  
Valley Forge National Historical Park

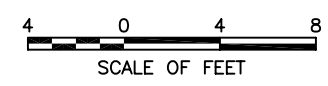
**JOHN MILNER ARCHITECTS, inc.**  
104 Lakeview Drive, Chadds Ford, Pennsylvania 19317 • (610) 388-0111

BUILDING  
CHRONOLOGY

SOUTH  
ELEVATION  
1769



WEST ELEVATION - 1769



Historic Structure Report  
**STIRLING'S QUARTERS**  
 Valley Forge National Historical Park

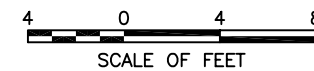
**JOHN MILNER ARCHITECTS, inc.**  
 104 Lakeview Drive, Chadds Ford, Pennsylvania 19317 • (610) 388-0111

BUILDING  
 CHRONOLOGY

WEST  
 ELEVATION  
 1769



NORTH ELEVATION - 1769

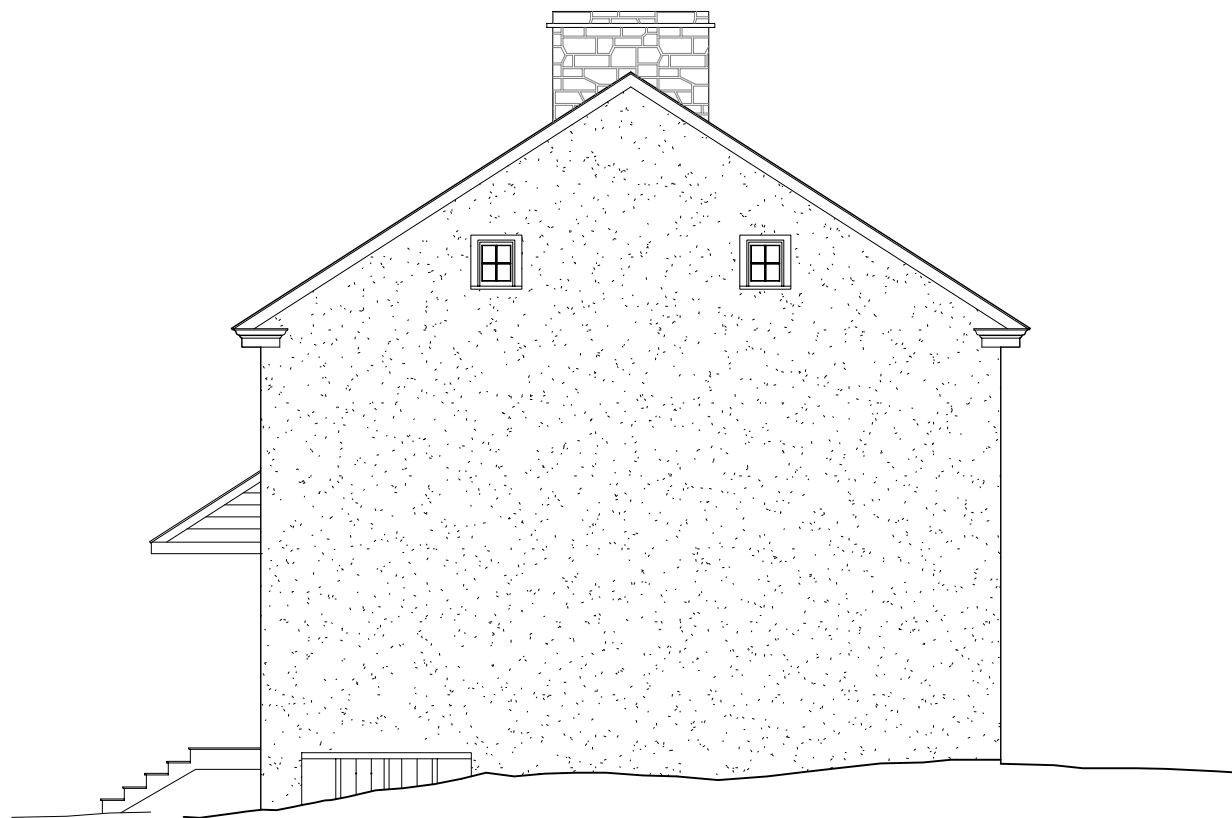


Historic Structure Report  
**STIRLING'S QUARTERS**  
Valley Forge National Historical Park

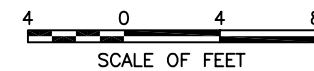
**JOHN MILNER ARCHITECTS, inc.**  
104 Lakeview Drive, Chadds Ford, Pennsylvania 19317 • (610) 388-0111

BUILDING  
CHRONOLOGY

NORTH  
ELEVATION  
1769



EAST ELEVATION - 1769



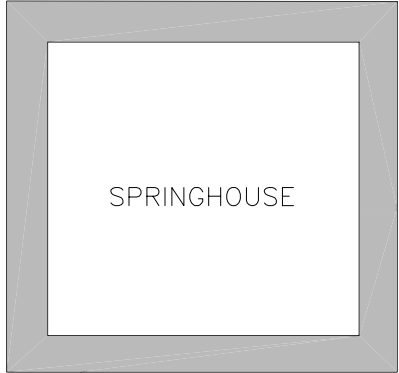
Historic Structure Report  
**STIRLING'S QUARTERS**  
Valley Forge National Historical Park

**JOHN MILNER ARCHITECTS, inc.**  
104 Lakeview Drive, Chadds Ford, Pennsylvania 19317 • (610) 388-0111

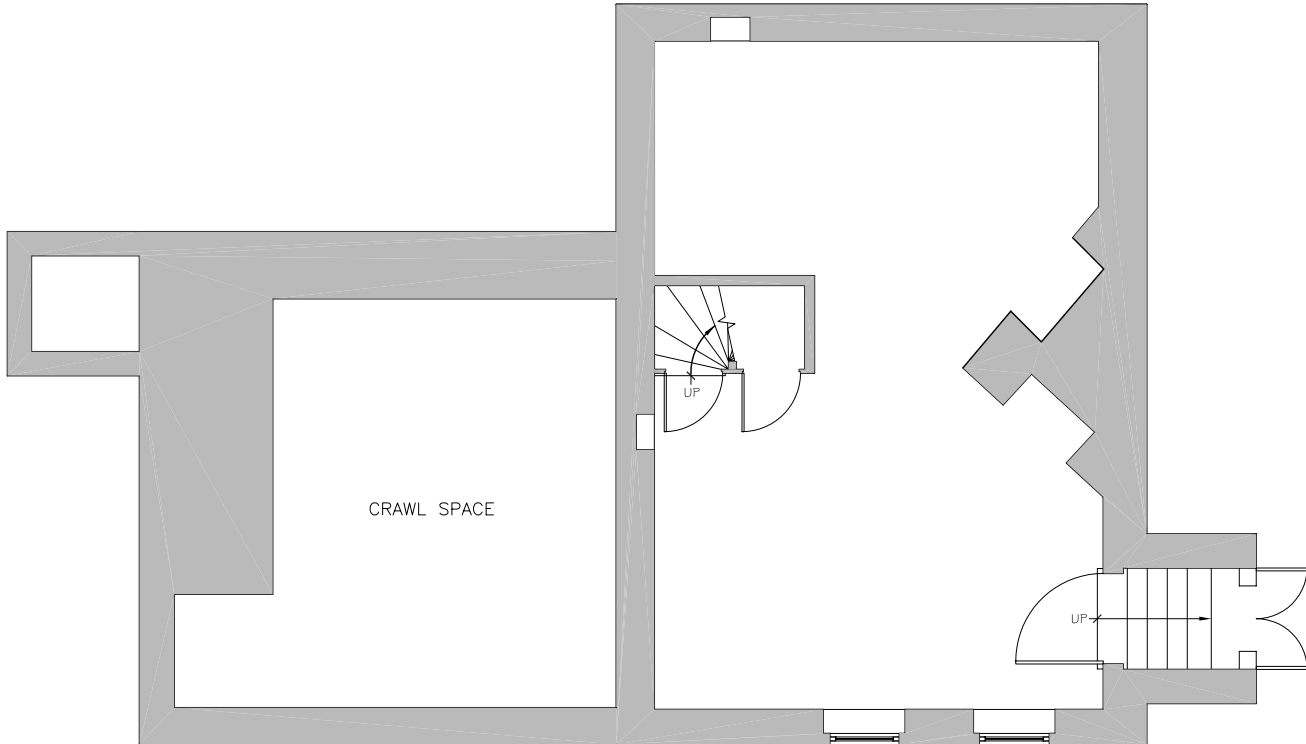
BUILDING  
CHRONOLOGY

EAST  
ELEVATION  
1769





SPRINGHOUSE

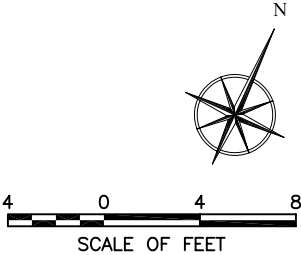


CRAWL SPACE

UP

UP

BASEMENT PLAN — 1769



SCALE OF FEET

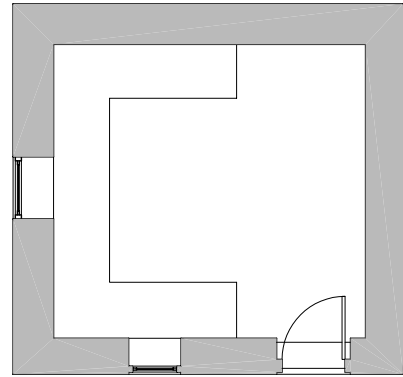
Copyright 2005 John Milner Architects, Inc.

Historic Structure Report  
**STIRLING'S QUARTERS**  
Valley Forge National Historical Park

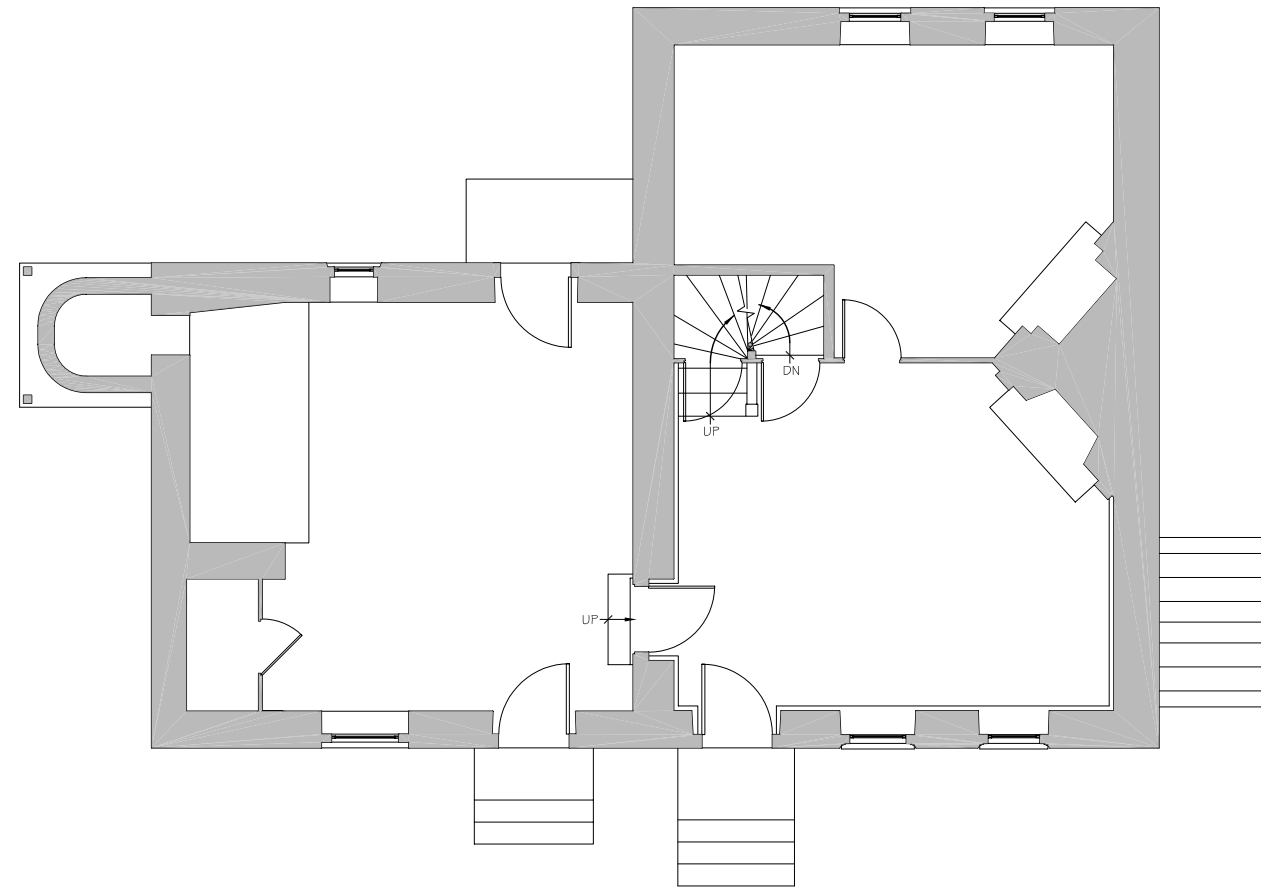
**JOHN MILNER ARCHITECTS, inc.**  
104 Lakeview Drive, Chadds Ford, Pennsylvania 19317 • (610) 388-0111

BUILDING  
CHRONOLOGY

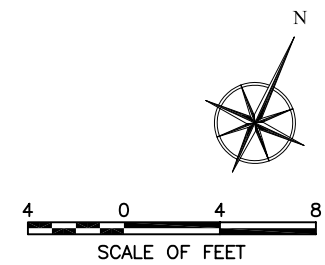
BASEMENT  
PLAN  
1769

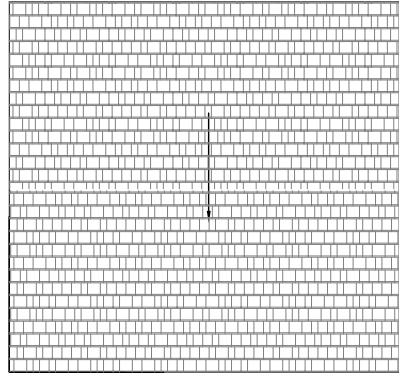


SPRINGHOUSE

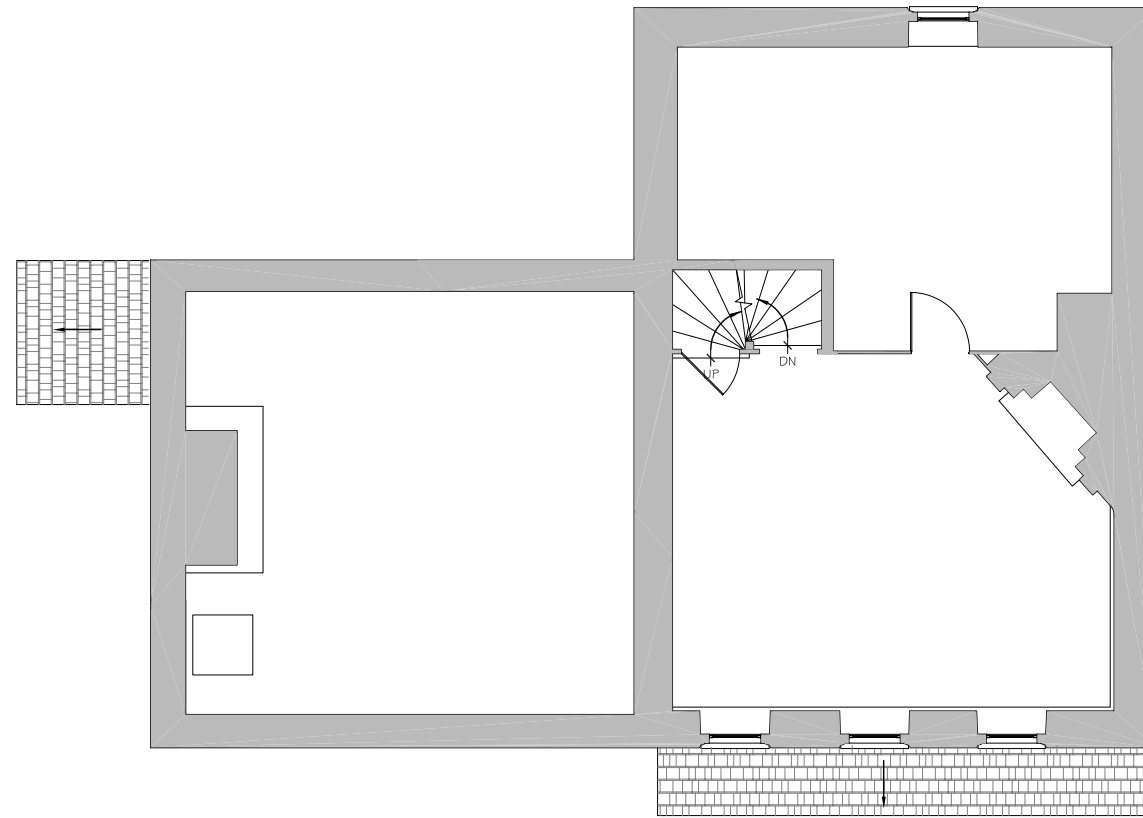


FIRST FLOOR PLAN - 1769

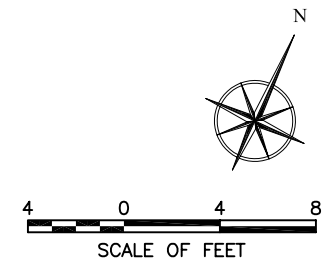




SPRINGHOUSE



SECOND FLOOR PLAN - 1769

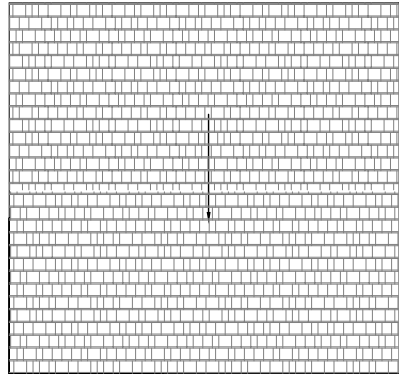


Historic Structure Report  
**STIRLING'S QUARTERS**  
Valley Forge National Historical Park

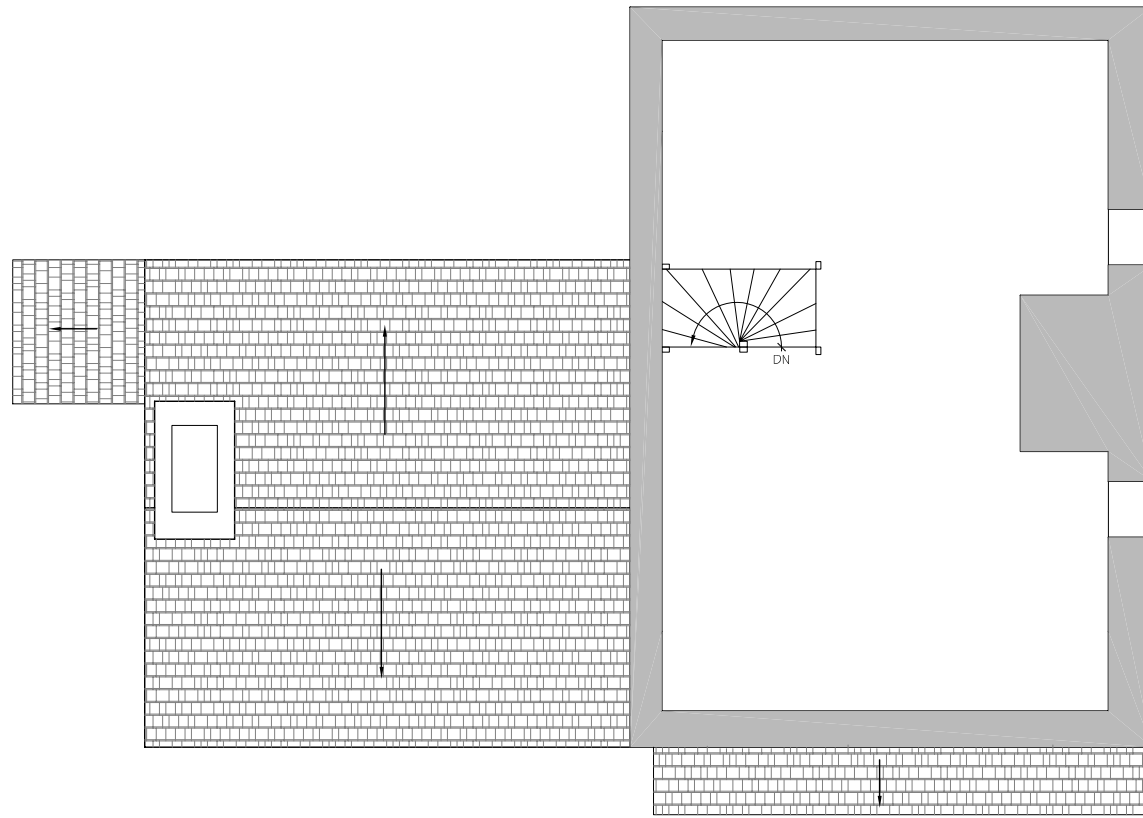
**JOHN MILNER ARCHITECTS, inc.**  
104 Lakeview Drive, Chadds Ford, Pennsylvania 19317 • (610) 388-0111

BUILDING  
CHRONOLOGY

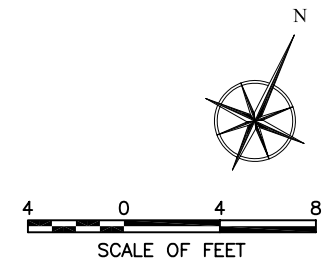
SECOND  
FLOOR PLAN  
1769



SPRINGHOUSE



ATTIC FLOOR PLAN - 1769



Copyright 2005 John Milner Architects, Inc.

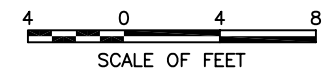
Historic Structure Report  
**STIRLING'S QUARTERS**  
Valley Forge National Historical Park  
**JOHN MILNER ARCHITECTS, inc.**  
104 Lakeview Drive, Chadds Ford, Pennsylvania 19317 • (610) 388-0111

BUILDING  
CHRONOLOGY

ATTIC  
FLOOR PLAN  
1769



SOUTH ELEVATION – 1790



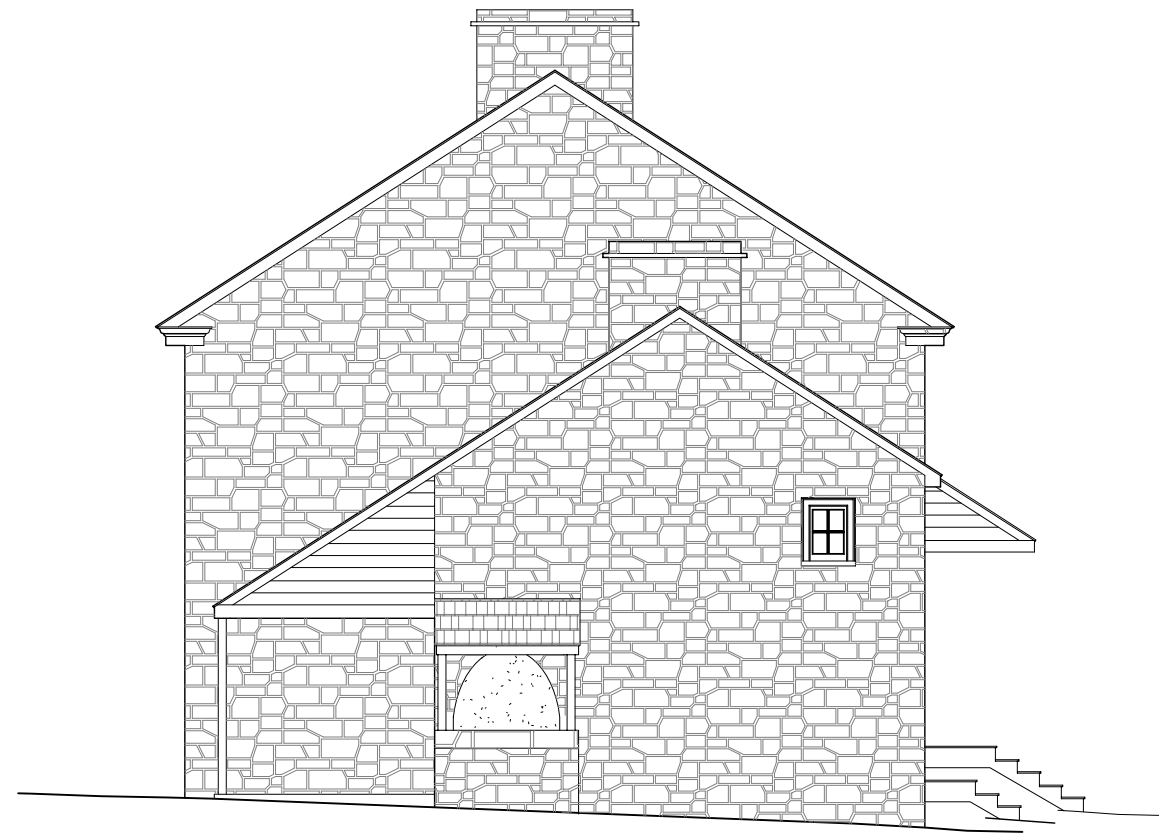
Historic Structure Report  
**STIRLING'S QUARTERS**  
 Valley Forge National Historical Park

**JOHN MILNER ARCHITECTS, inc.**  
 104 Lakeview Drive, Chadds Ford, Pennsylvania 19317 • (610) 388-0111

BUILDING  
 CHRONOLOGY

SOUTH  
 ELEVATION  
 1790





WEST ELEVATION - 1790



Historic Structure Report  
**STIRLING'S QUARTERS**  
Valley Forge National Historical Park

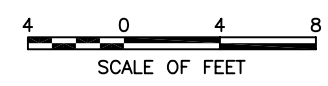
**JOHN MILNER ARCHITECTS, inc.**  
104 Lakeview Drive, Chadds Ford, Pennsylvania 19317 • (610) 388-0111

BUILDING  
CHRONOLOGY

WEST  
ELEVATION  
1790



NORTH ELEVATION - 1790

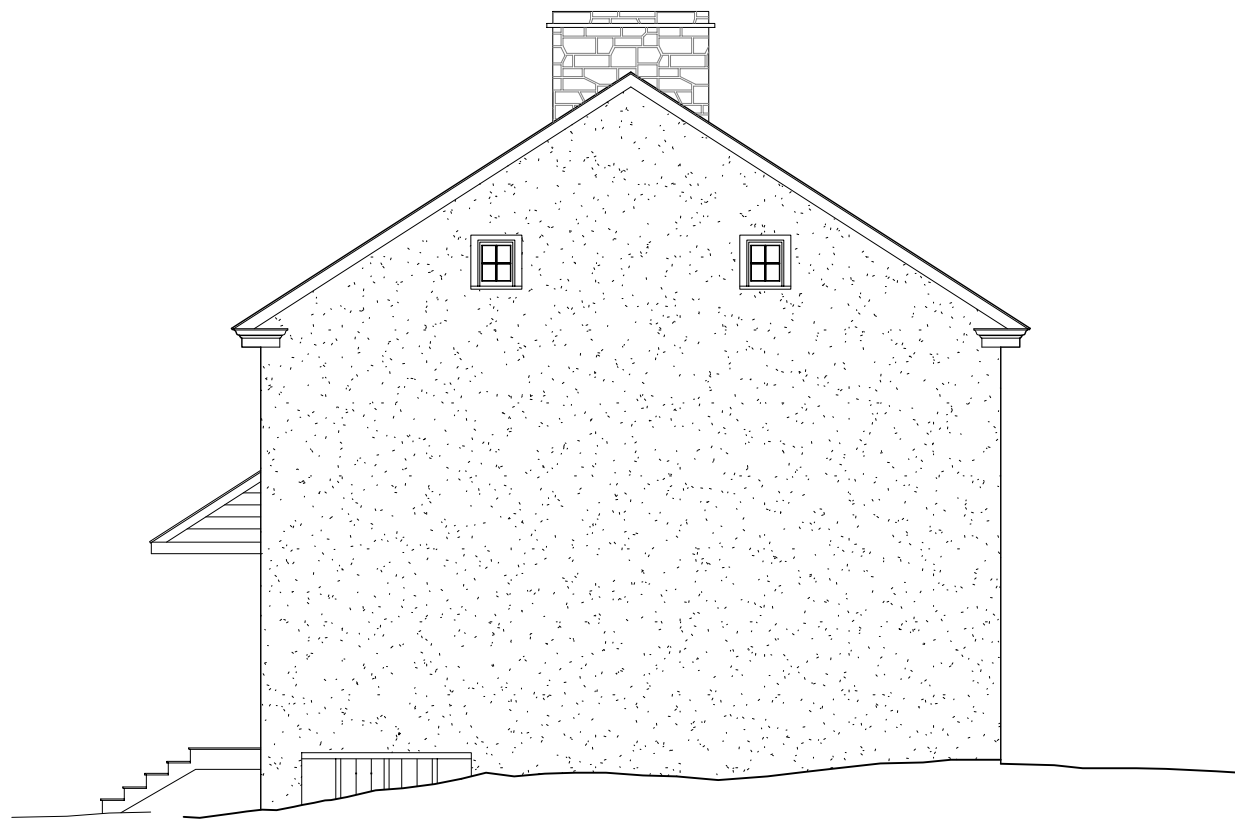


Historic Structure Report  
**STIRLING'S QUARTERS**  
 Valley Forge National Historical Park

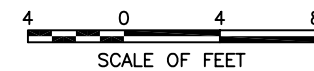
**JOHN MILNER ARCHITECTS, inc.**  
 104 Lakeview Drive, Chadds Ford, Pennsylvania 19317 • (610) 388-0111

BUILDING  
 CHRONOLOGY

NORTH  
 ELEVATION  
 1790



EAST ELEVATION — 1790

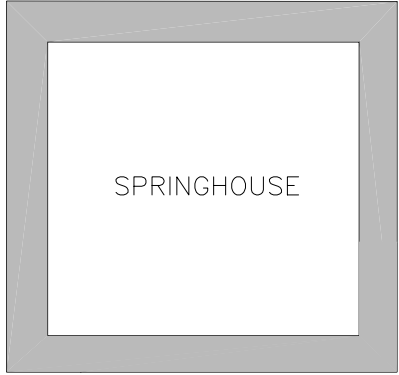


Historic Structure Report  
**STIRLING'S QUARTERS**  
Valley Forge National Historical Park

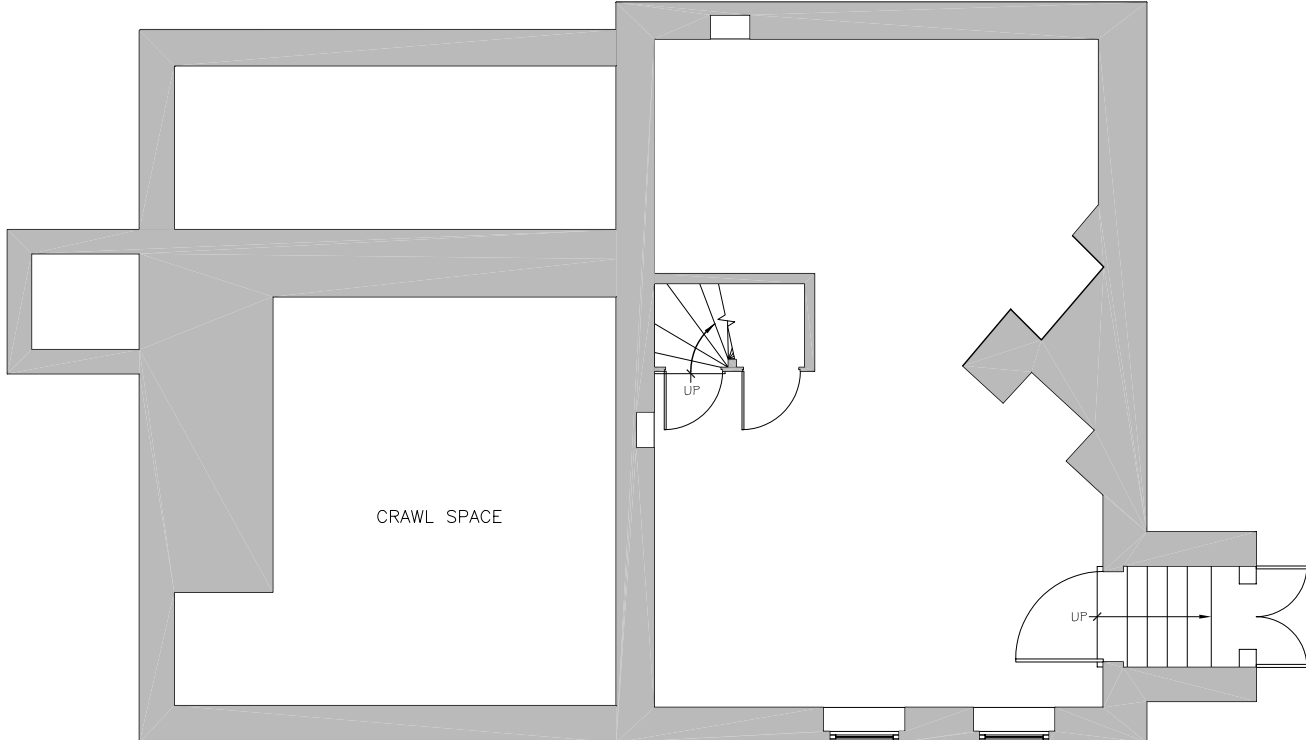
**JOHN MILNER ARCHITECTS, inc.**  
104 Lakeview Drive, Chadds Ford, Pennsylvania 19317 • (610) 388-0111

BUILDING  
CHRONOLOGY

EAST  
ELEVATION  
1790

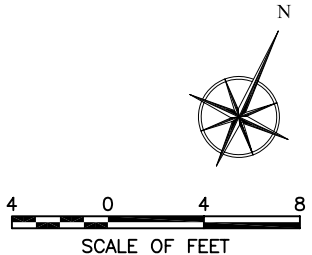


SPRINGHOUSE



CRAWL SPACE

BASEMENT PLAN - 1790



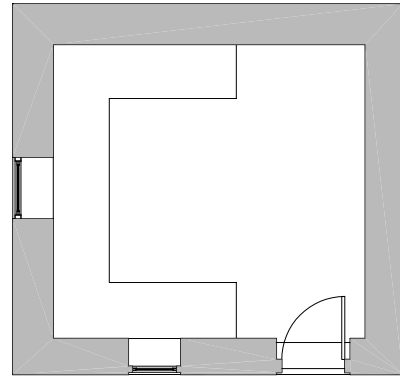
Copyright 2005 John Milner Architects, Inc.

Historic Structure Report  
**STIRLING'S QUARTERS**  
Valley Forge National Historical Park

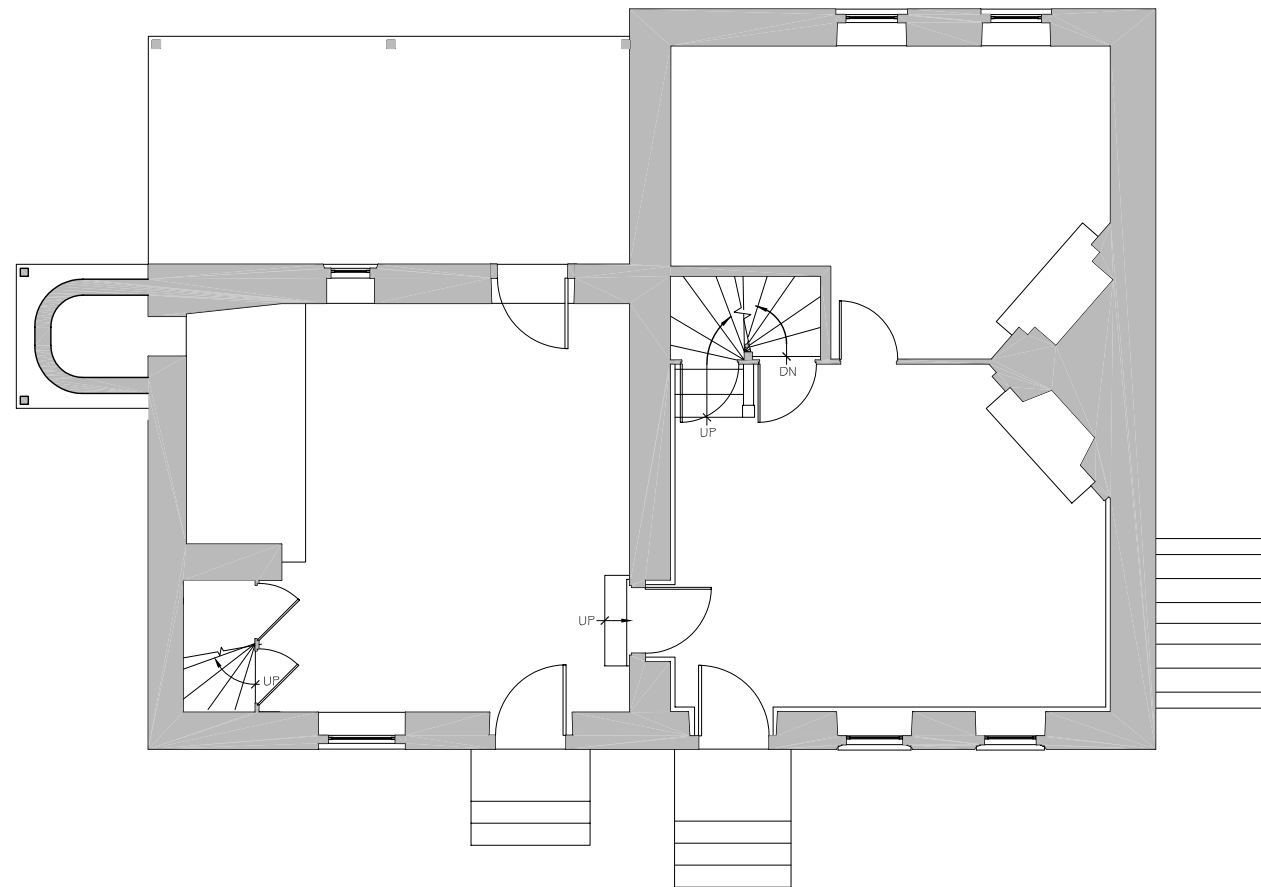
**JOHN MILNER ARCHITECTS, inc.**  
104 Lakeview Drive, Chadds Ford, Pennsylvania 19317 • (610) 388-0111

BUILDING  
CHRONOLOGY

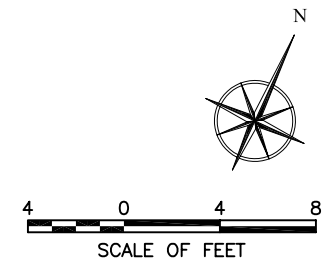
BASEMENT  
PLAN  
1790



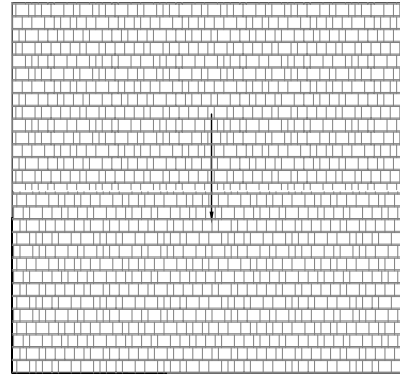
SPRINGHOUSE



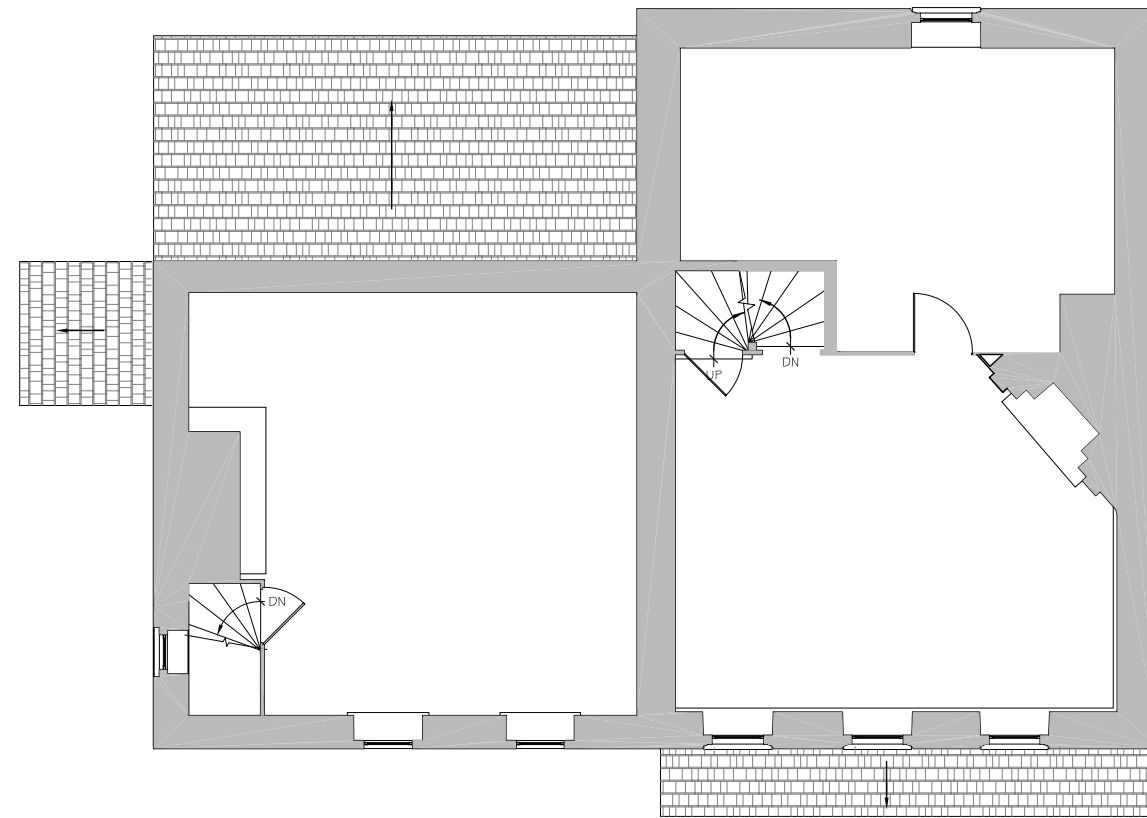
FIRST FLOOR PLAN - 1790



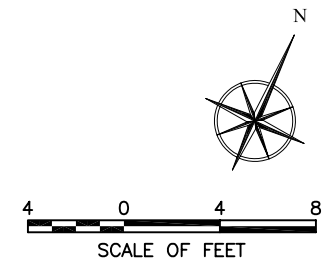




SPRINGHOUSE



SECOND FLOOR PLAN - 1790

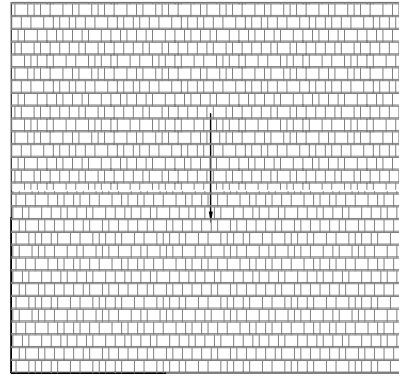


Historic Structure Report  
**STIRLING'S QUARTERS**  
Valley Forge National Historical Park

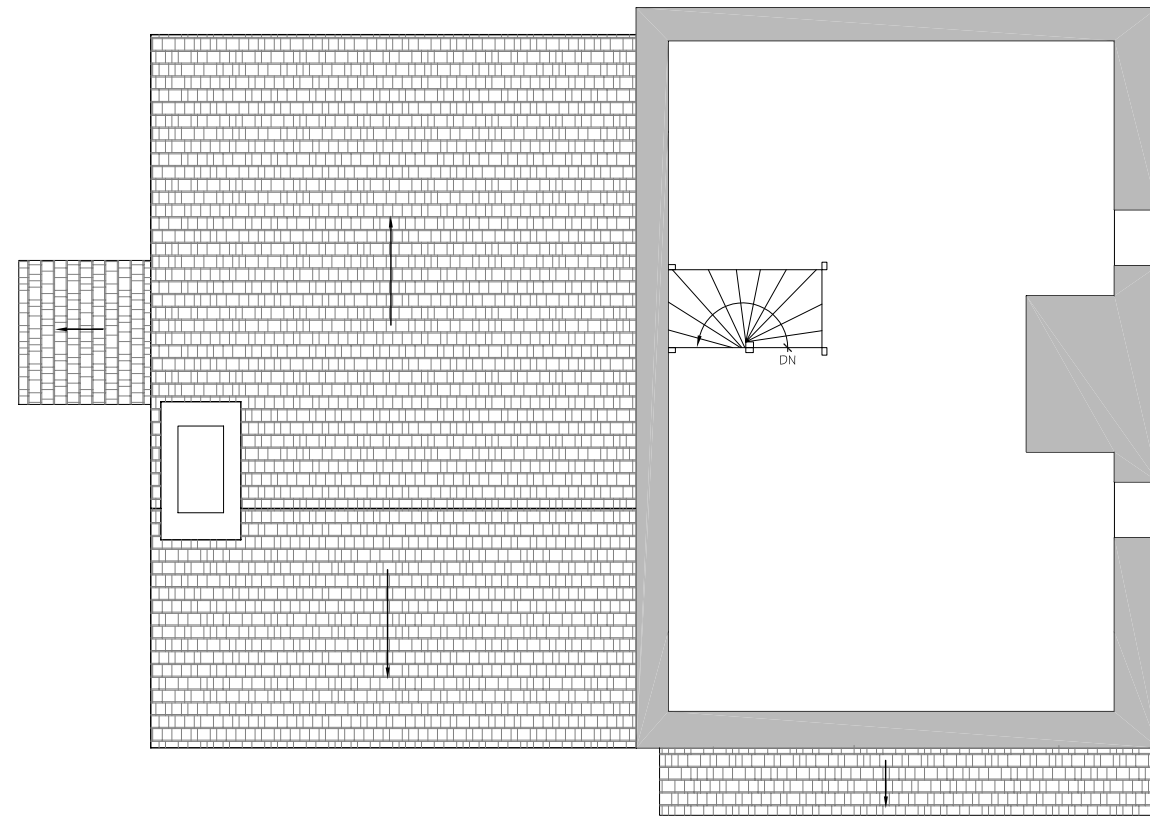
**JOHN MILNER ARCHITECTS, inc.**  
104 Lakeview Drive, Chadds Ford, Pennsylvania 19317 • (610) 388-0111

BUILDING  
CHRONOLOGY

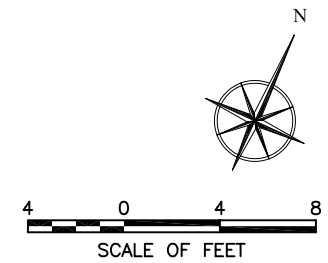
SECOND  
FLOOR PLAN  
1790



SPRINGHOUSE

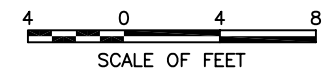


ATTIC FLOOR PLAN - 1790





SOUTH ELEVATION — 1810



Historic Structure Report  
**STIRLING'S QUARTERS**  
 Valley Forge National Historical Park

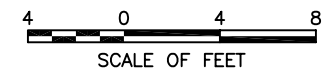
**JOHN MILNER ARCHITECTS, inc.**  
 104 Lakeview Drive, Chadds Ford, Pennsylvania 19317 • (610) 388-0111

BUILDING  
 CHRONOLOGY

SOUTH  
 ELEVATION  
 1810



WEST ELEVATION - 1810



Historic Structure Report  
**STIRLING'S QUARTERS**  
Valley Forge National Historical Park

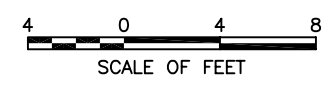
**JOHN MILNER ARCHITECTS, inc.**  
104 Lakeview Drive, Chadds Ford, Pennsylvania 19317 • (610) 388-0111

BUILDING  
CHRONOLOGY

WEST  
ELEVATION  
1810



NORTH ELEVATION - 1810

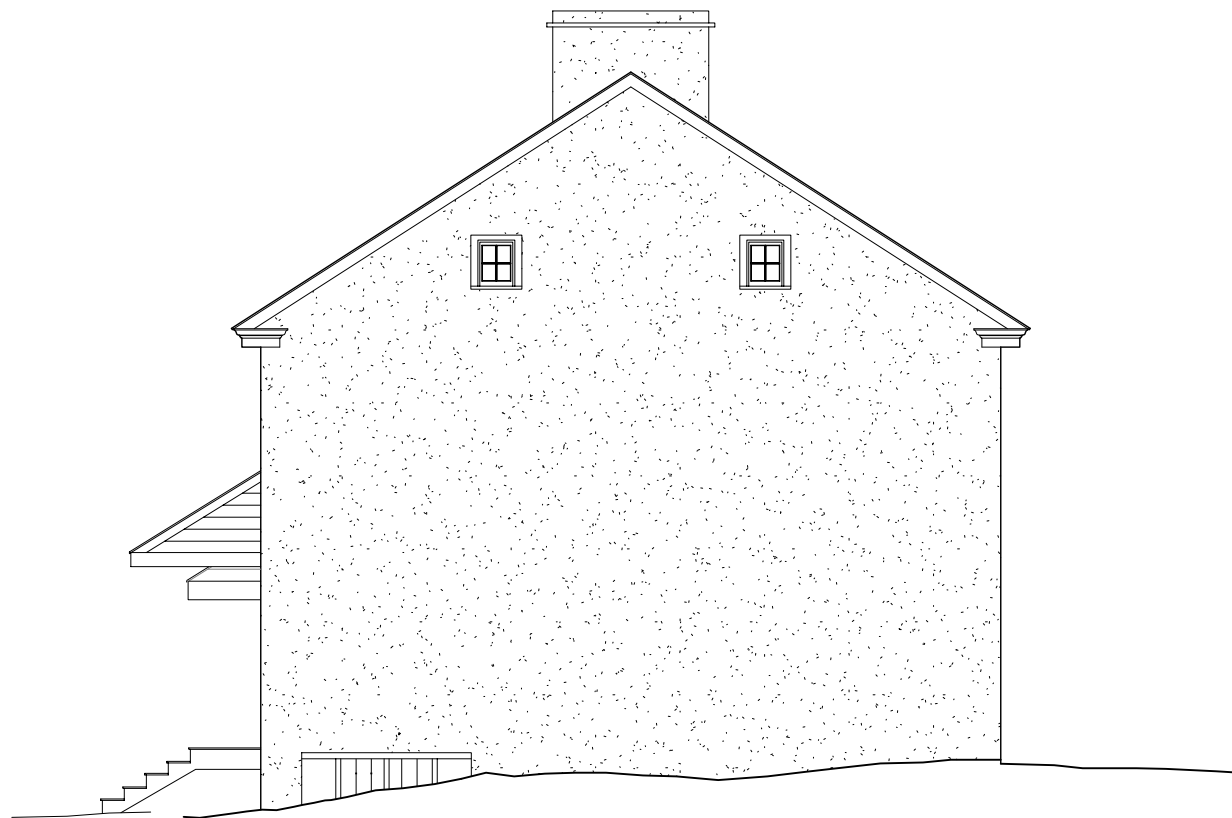


Historic Structure Report  
**STIRLING'S QUARTERS**  
Valley Forge National Historical Park  
**JOHN MILNER ARCHITECTS, inc.**  
104 Lakeview Drive, Chadds Ford, Pennsylvania 19317 • (610) 388-0111

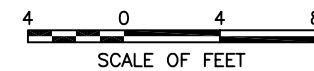
BUILDING  
CHRONOLOGY

NORTH  
ELEVATION  
1810





EAST ELEVATION — 1810

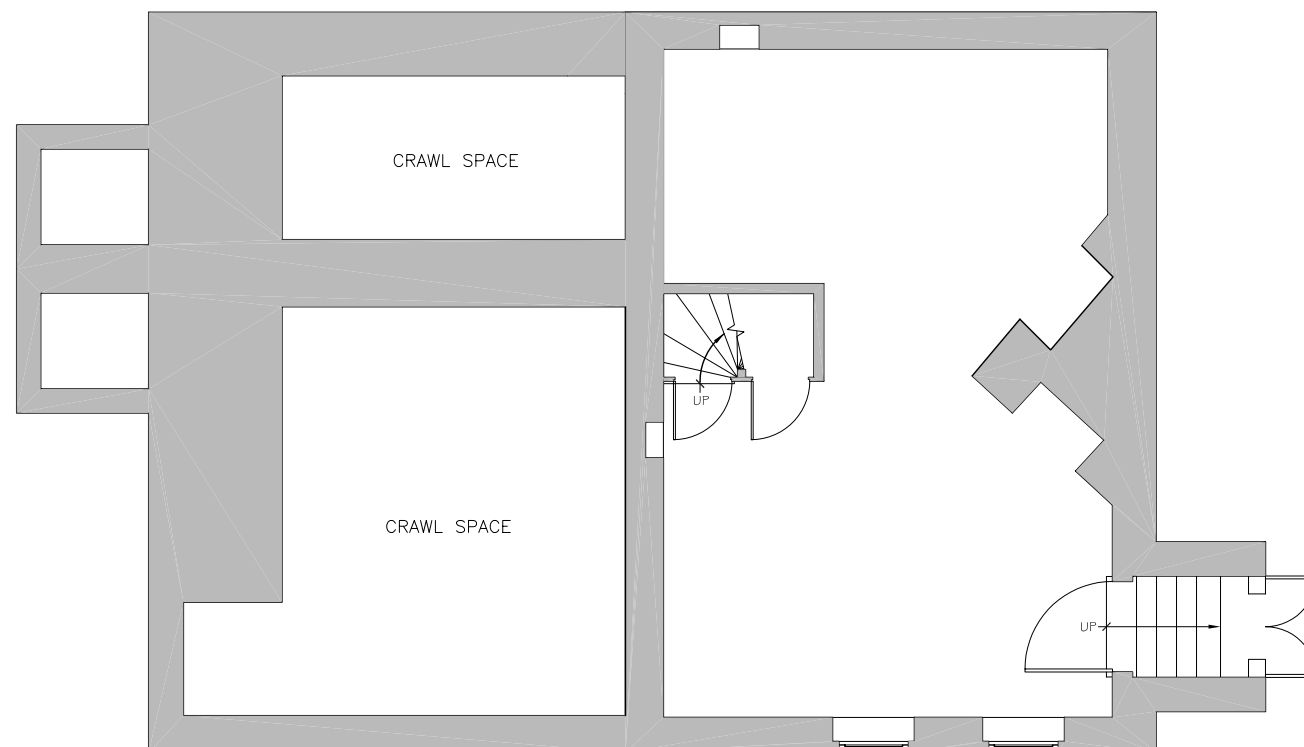
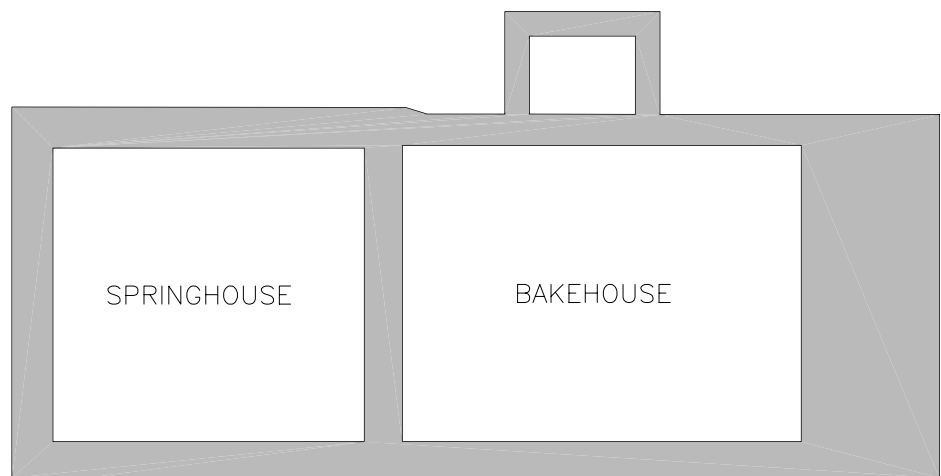


Historic Structure Report  
**STIRLING'S QUARTERS**  
Valley Forge National Historical Park

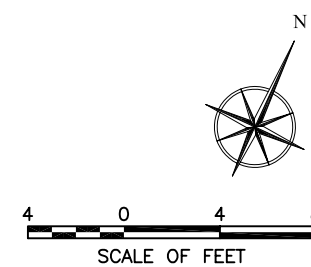
**JOHN MILNER ARCHITECTS, inc.**  
104 Lakeview Drive, Chadds Ford, Pennsylvania 19317 • (610) 388-0111

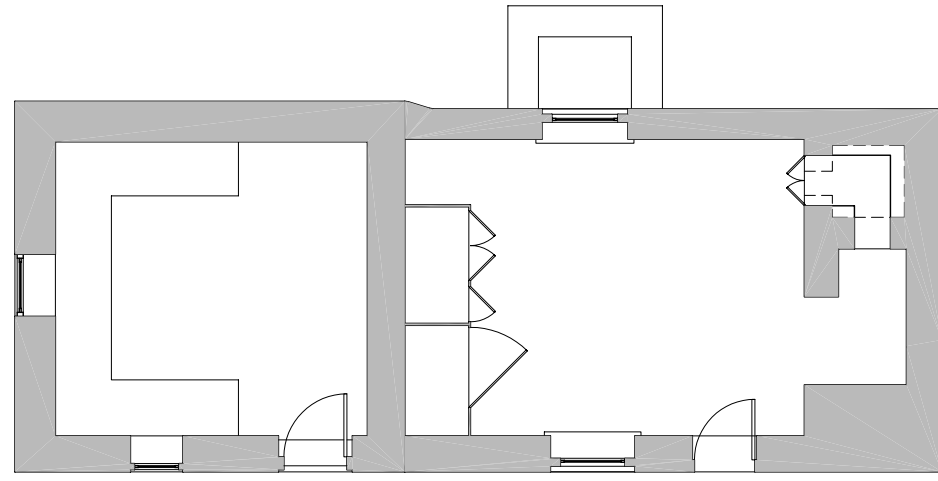
BUILDING  
CHRONOLOGY

EAST  
ELEVATION  
1810



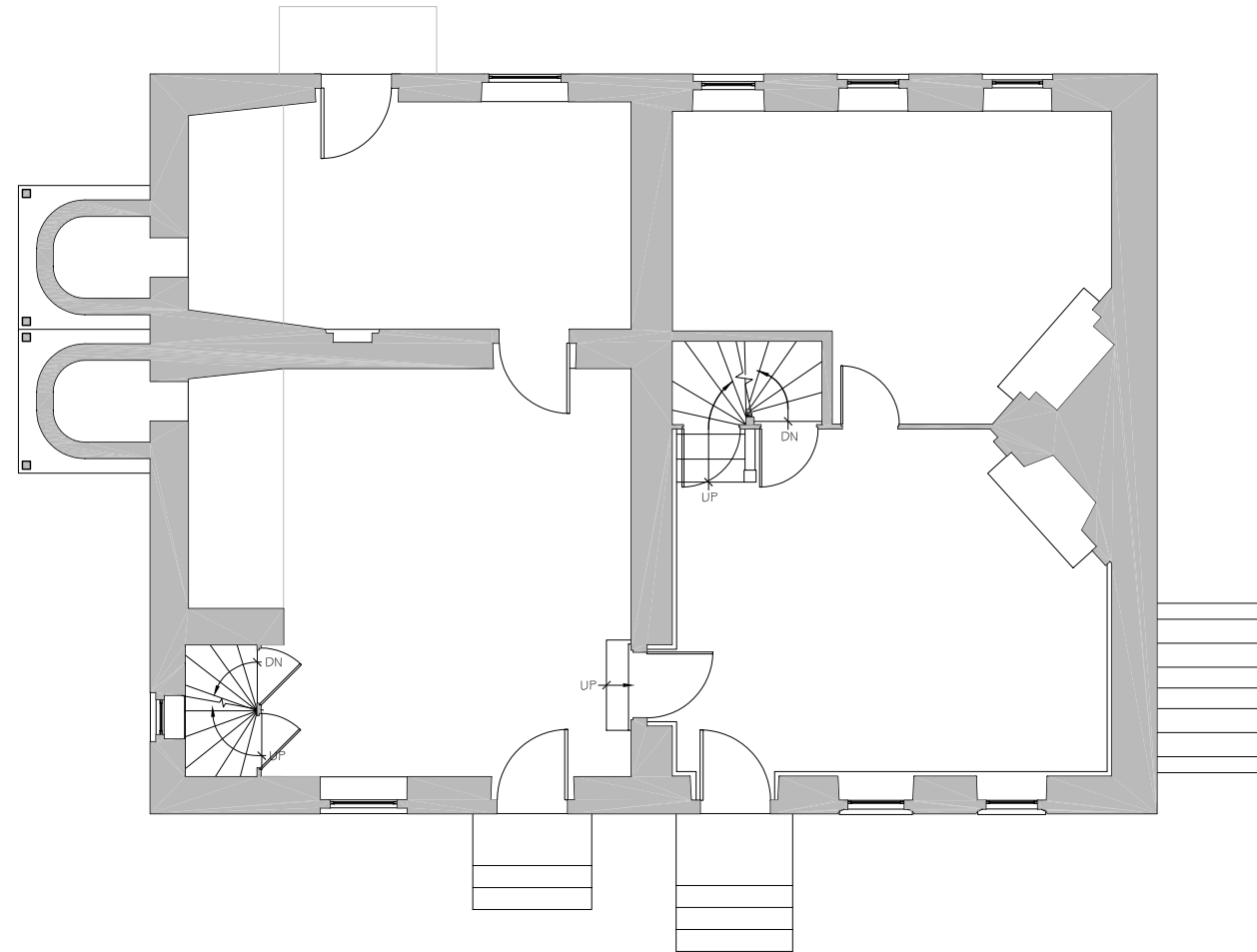
BASEMENT PLAN - 1810



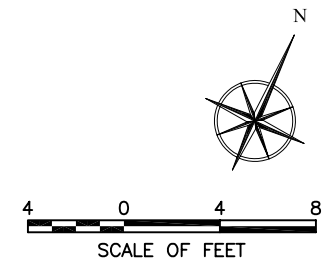


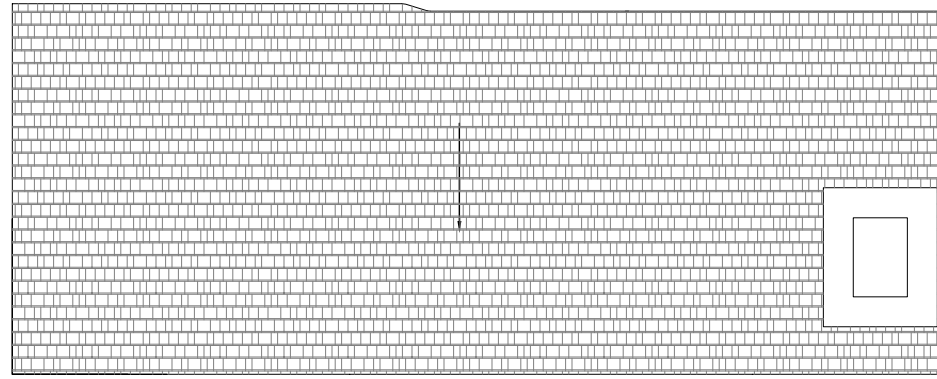
SPRINGHOUSE

BAKEHOUSE



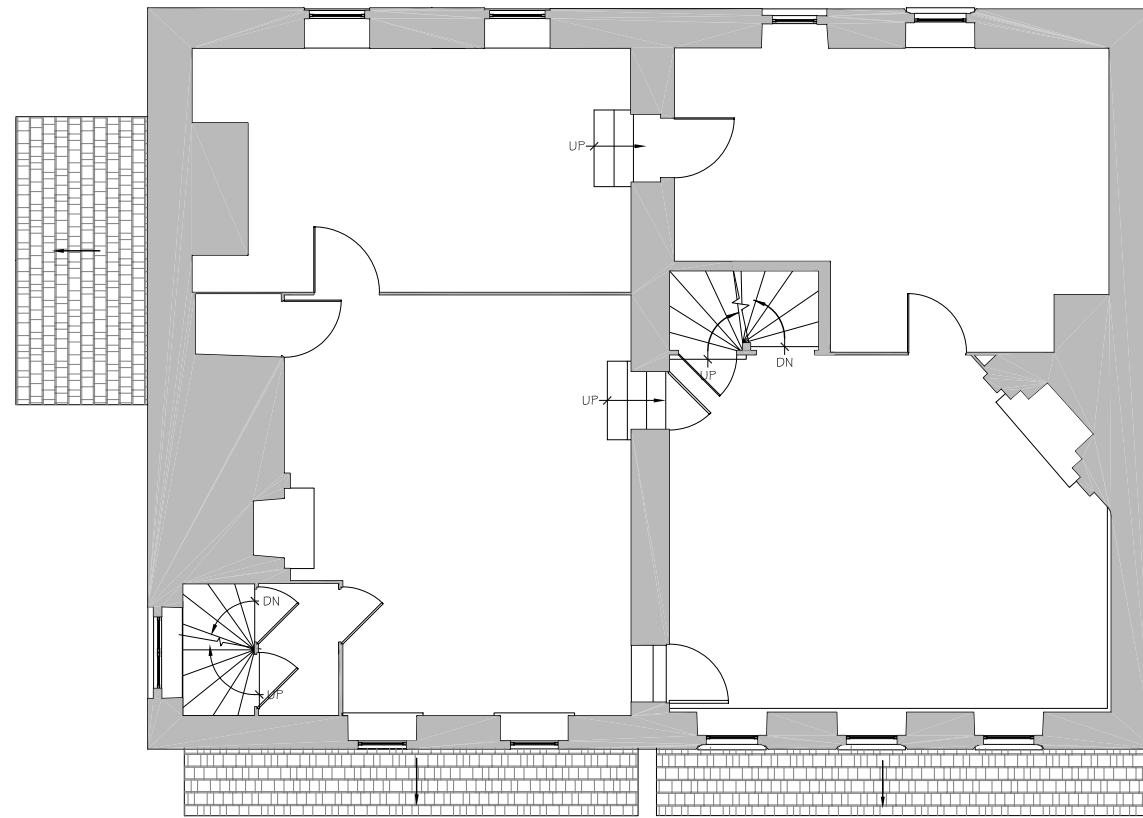
FIRST FLOOR PLAN — 1810



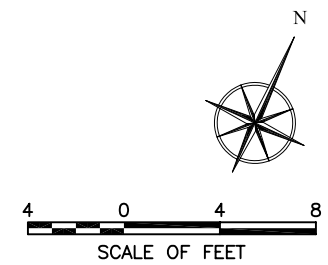


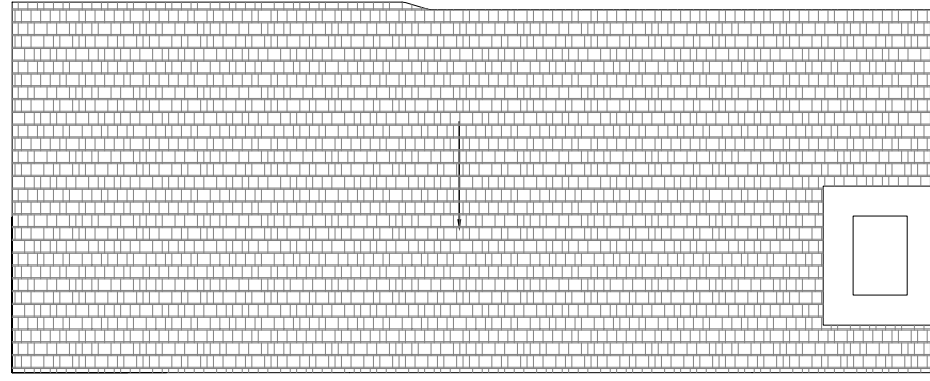
SPRINGHOUSE

BAKEHOUSE



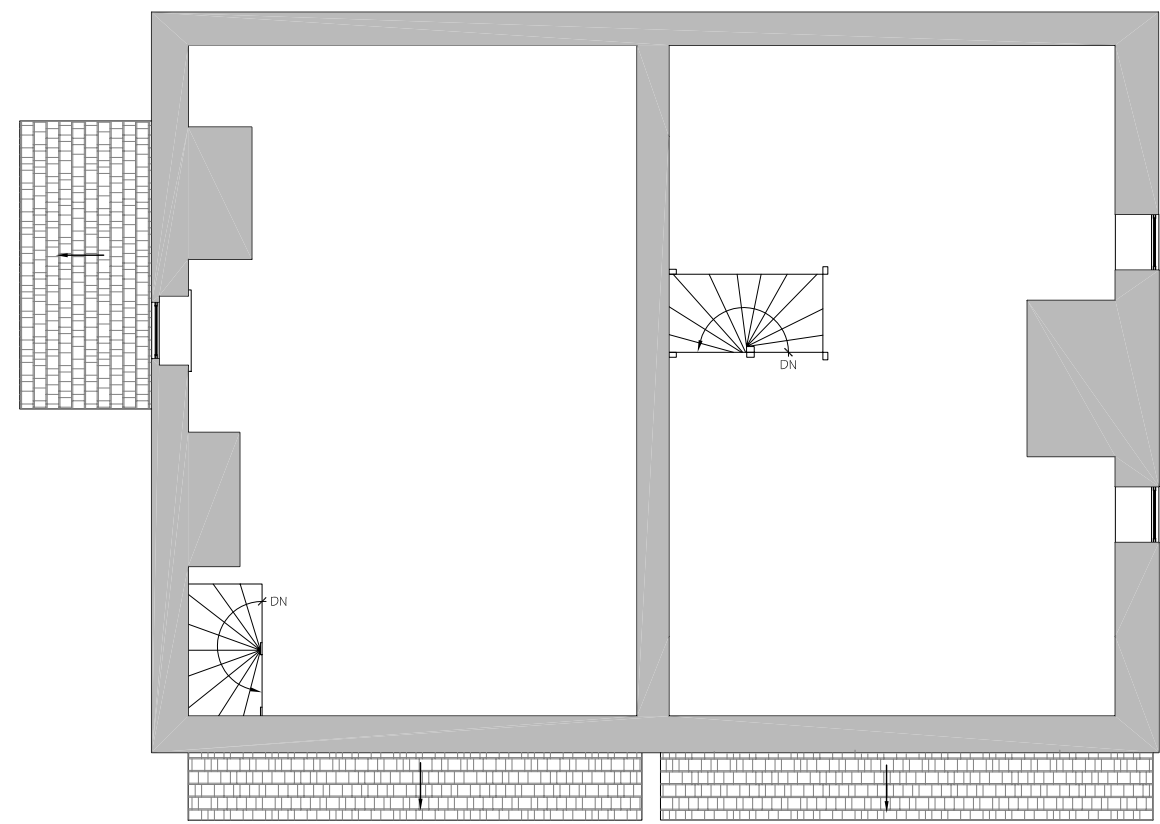
SECOND FLOOR PLAN - 1810



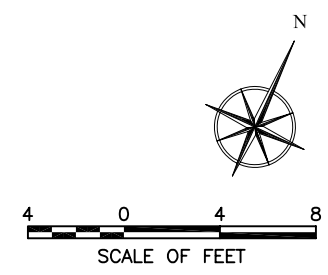


SPRINGHOUSE

BAKEHOUSE



ATTIC FLOOR PLAN - 1810



Copyright 2005 John Milner Architects, Inc.

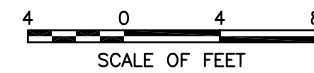
Historic Structure Report  
**STIRLING'S QUARTERS**  
 Valley Forge National Historical Park  
**JOHN MILNER ARCHITECTS, inc.**  
 104 Lakeview Drive, Chadds Ford, Pennsylvania 19317 • (610) 388-0111

BUILDING  
 CHRONOLOGY

ATTIC  
 FLOOR PLAN  
 1810



SOUTH ELEVATION – 1830



Copyright 2005 John Milner Architects, Inc.

Historic Structure Report  
**STIRLING'S QUARTERS**  
 Valley Forge National Historical Park

**JOHN MILNER ARCHITECTS, inc.**  
 104 Lakeview Drive, Chadds Ford, Pennsylvania 19317 • (610) 388-0111

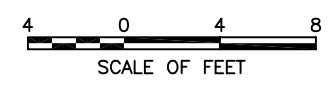
BUILDING  
 CHRONOLOGY

SOUTH  
 ELEVATION  
 1830





WEST ELEVATION - 1830



Historic Structure Report  
**STIRLING'S QUARTERS**  
Valley Forge National Historical Park

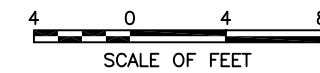
**JOHN MILNER ARCHITECTS, inc.**  
104 Lakeview Drive, Chadds Ford, Pennsylvania 19317 • (610) 388-0111

BUILDING  
CHRONOLOGY

WEST  
ELEVATION  
1830



NORTH ELEVATION — 1830



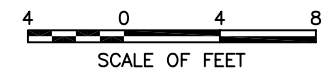
Historic Structure Report  
**STIRLING'S QUARTERS**  
 Valley Forge National Historical Park  
**JOHN MILNER ARCHITECTS, inc.**  
 104 Lakeview Drive, Chadds Ford, Pennsylvania 19317 • (610) 388-0111

BUILDING  
 CHRONOLOGY

NORTH  
 ELEVATION  
 1830



EAST ELEVATION — 1830



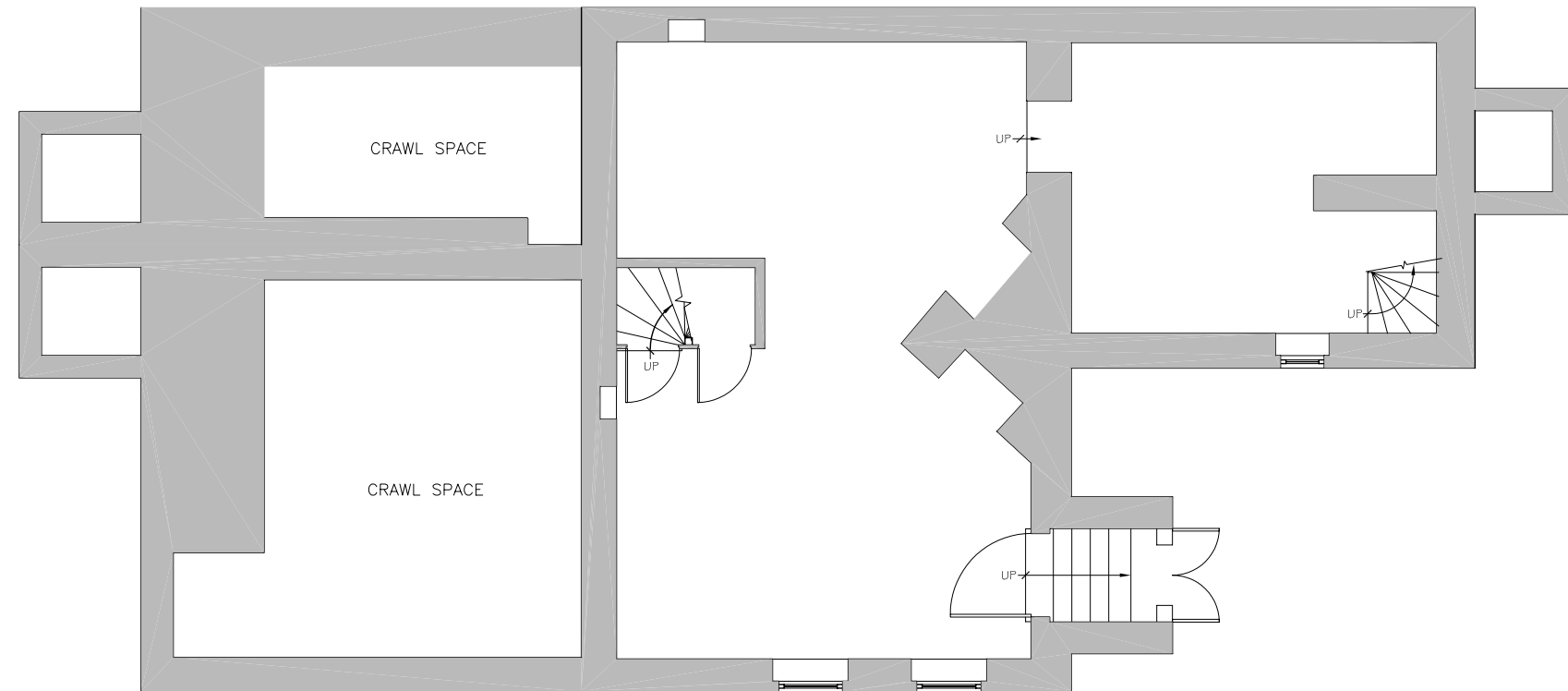
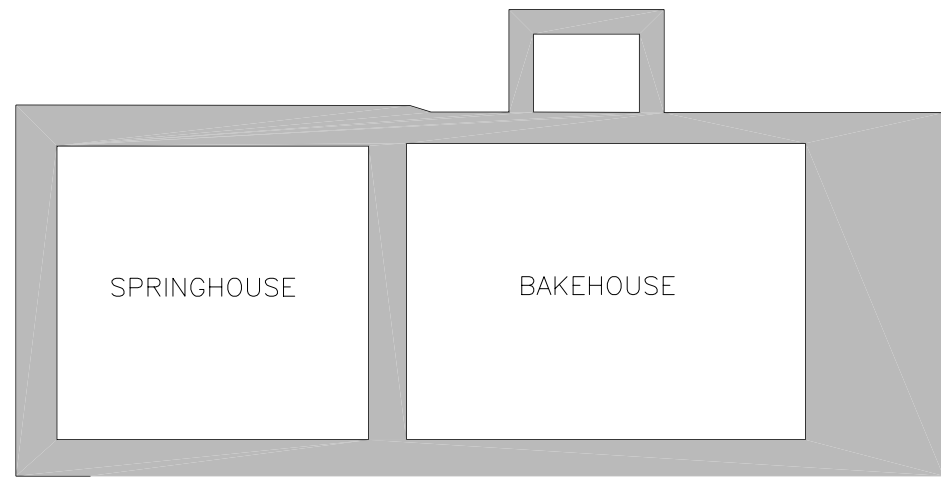
SCALE OF FEET

Historic Structure Report  
**STIRLING'S QUARTERS**  
Valley Forge National Historical Park

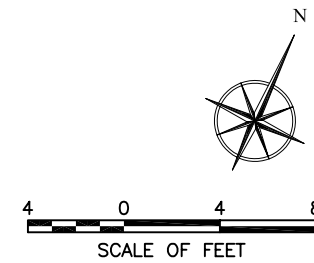
**JOHN MILNER ARCHITECTS, inc.**  
104 Lakeview Drive, Chadds Ford, Pennsylvania 19317 • (610) 388-0111

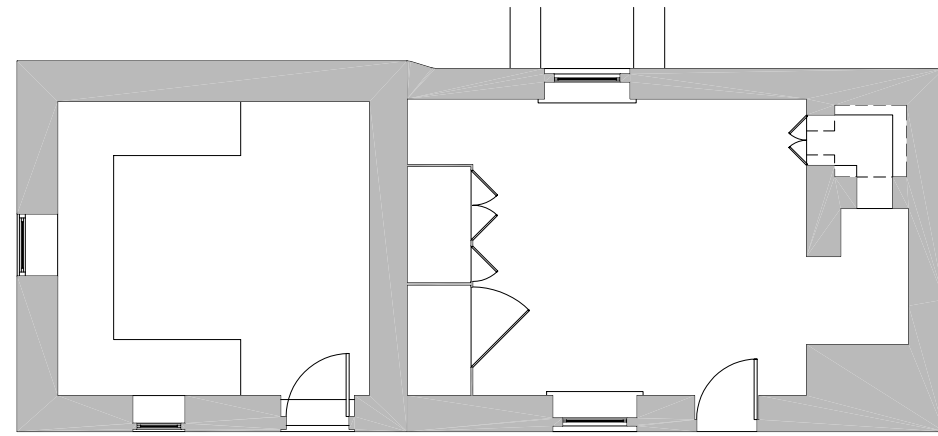
BUILDING  
CHRONOLOGY

EAST  
ELEVATION  
1830



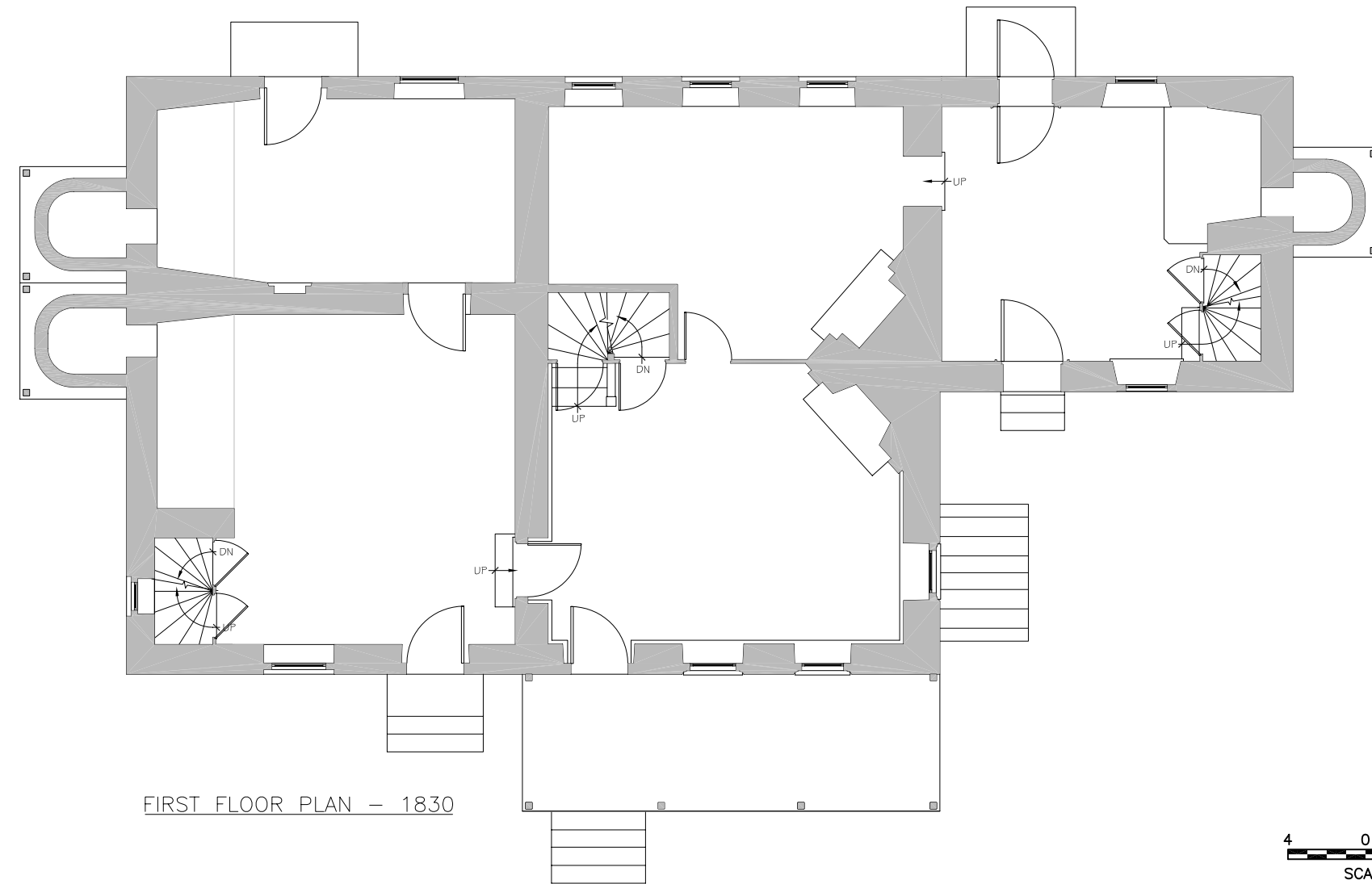
BASEMENT PLAN - 1830



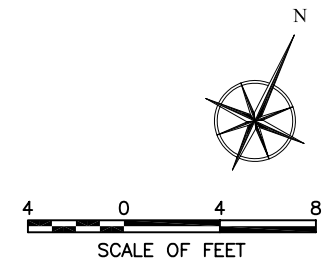


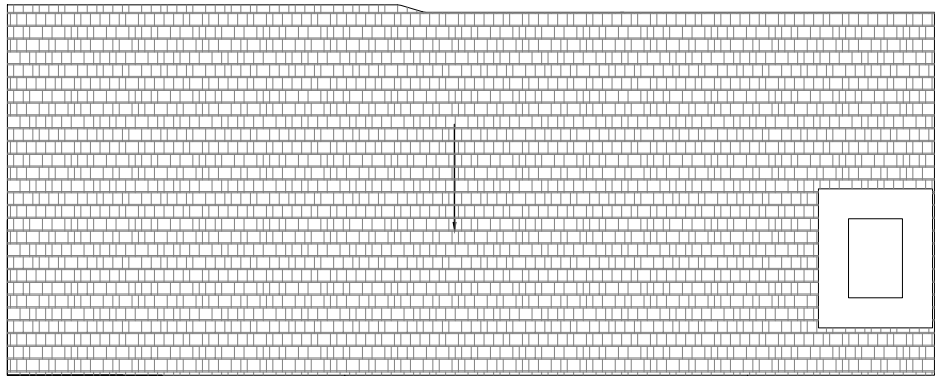
SPRINGHOUSE

BAKEHOUSE



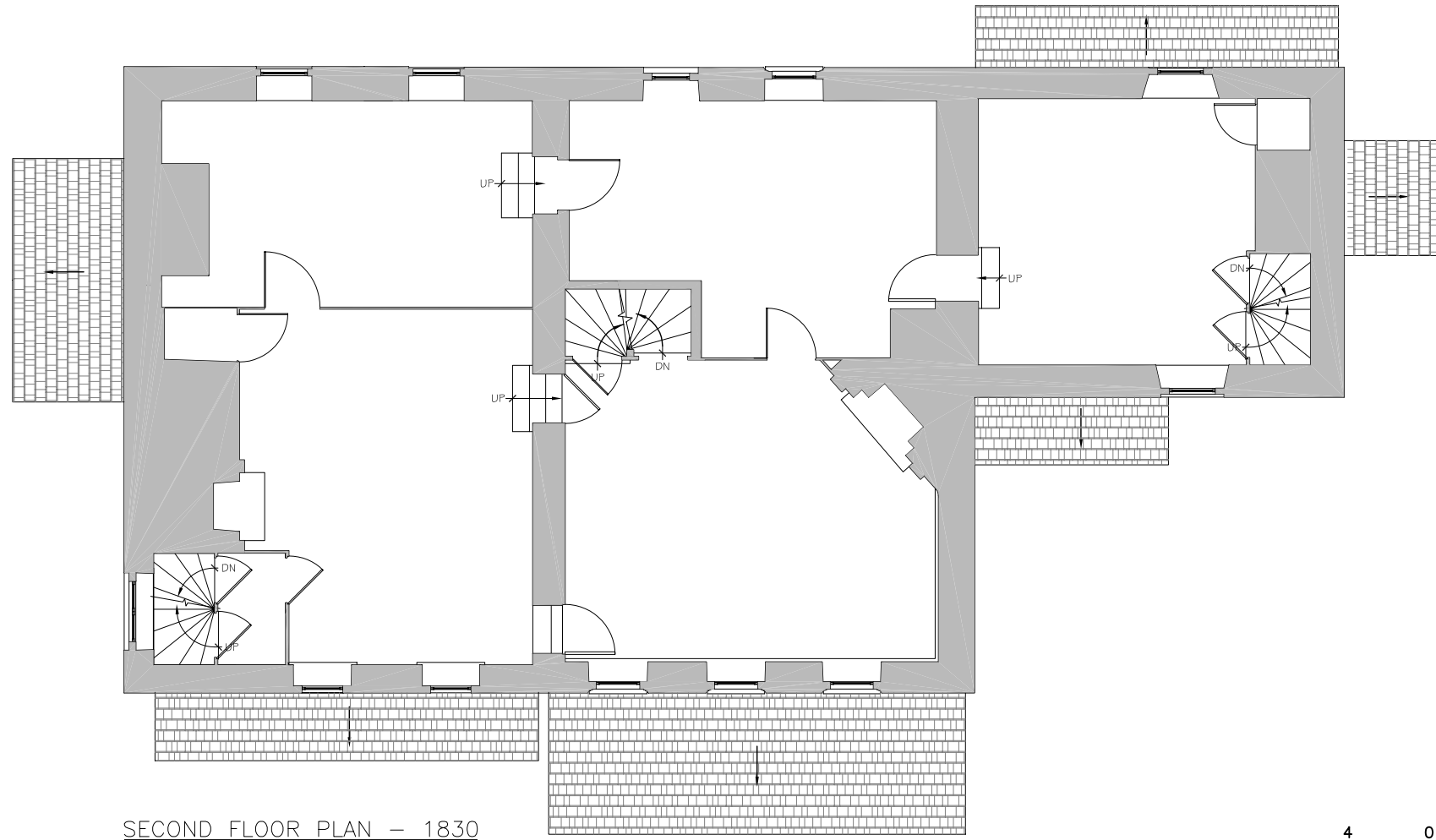
FIRST FLOOR PLAN — 1830



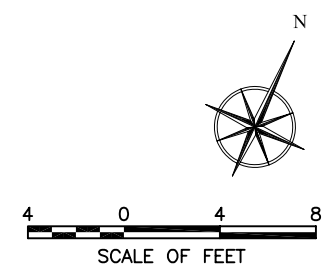


SPRINGHOUSE

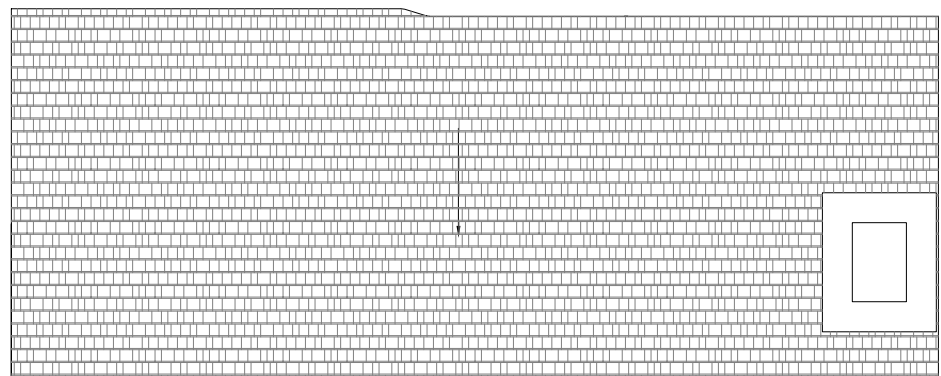
BAKEHOUSE



SECOND FLOOR PLAN - 1830

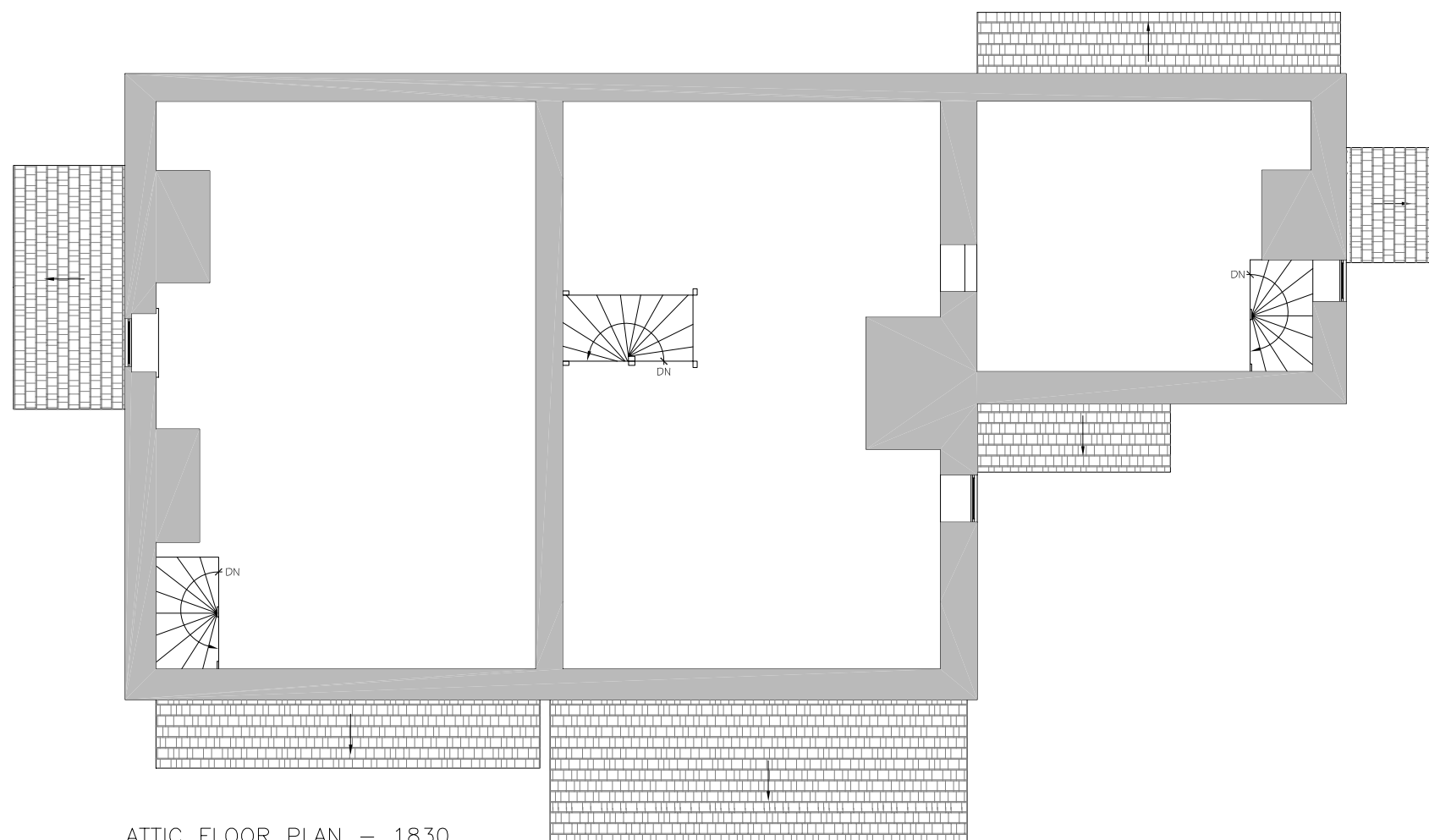




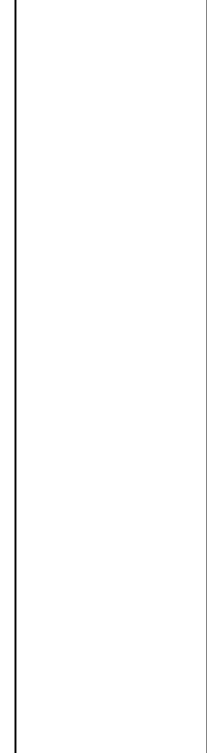
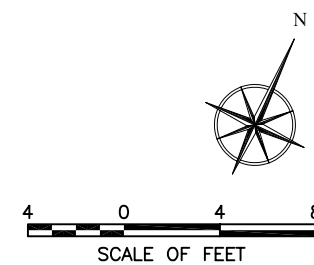


SPRINGHOUSE

BAKEHOUSE



ATTIC FLOOR PLAN - 1830



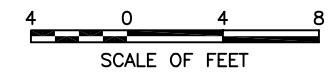
Historic Structure Report  
**STIRLING'S QUARTERS**  
 Valley Forge National Historical Park  
**JOHN MILNER ARCHITECTS, inc.**  
 104 Lakeview Drive, Chadds Ford, Pennsylvania 19317 • (610) 388-0111

BUILDING  
 CHRONOLOGY

ATTIC  
 FLOOR PLAN  
 1830



SOUTH ELEVATION — 1926



SCALE OF FEET

Historic Structure Report  
**STIRLING'S QUARTERS**  
Valley Forge National Historical Park

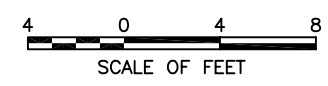
**JOHN MILNER ARCHITECTS, inc.**  
104 Lakeview Drive, Chadds Ford, Pennsylvania 19317 • (610) 388-0111

BUILDING  
CHRONOLOGY

SOUTH  
ELEVATION  
1926



WEST ELEVATION — 1926



Historic Structure Report  
**STIRLING'S QUARTERS**  
Valley Forge National Historical Park

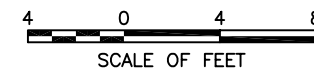
**JOHN MILNER ARCHITECTS, inc.**  
104 Lakeview Drive, Chadds Ford, Pennsylvania 19317 • (610) 388-0111

BUILDING  
CHRONOLOGY

WEST  
ELEVATION  
1926



NORTH ELEVATION — 1926



SCALE OF FEET

Copyright 2005 John Milner Architects, Inc.

Historic Structure Report  
**STIRLING'S QUARTERS**  
Valley Forge National Historical Park

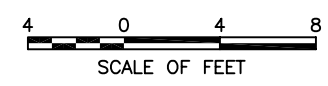
**JOHN MILNER ARCHITECTS, inc.**  
104 Lakeview Drive, Chadds Ford, Pennsylvania 19317 • (610) 388-0111

BUILDING  
CHRONOLOGY

NORTH  
ELEVATION  
1926



EAST ELEVATION — 1926

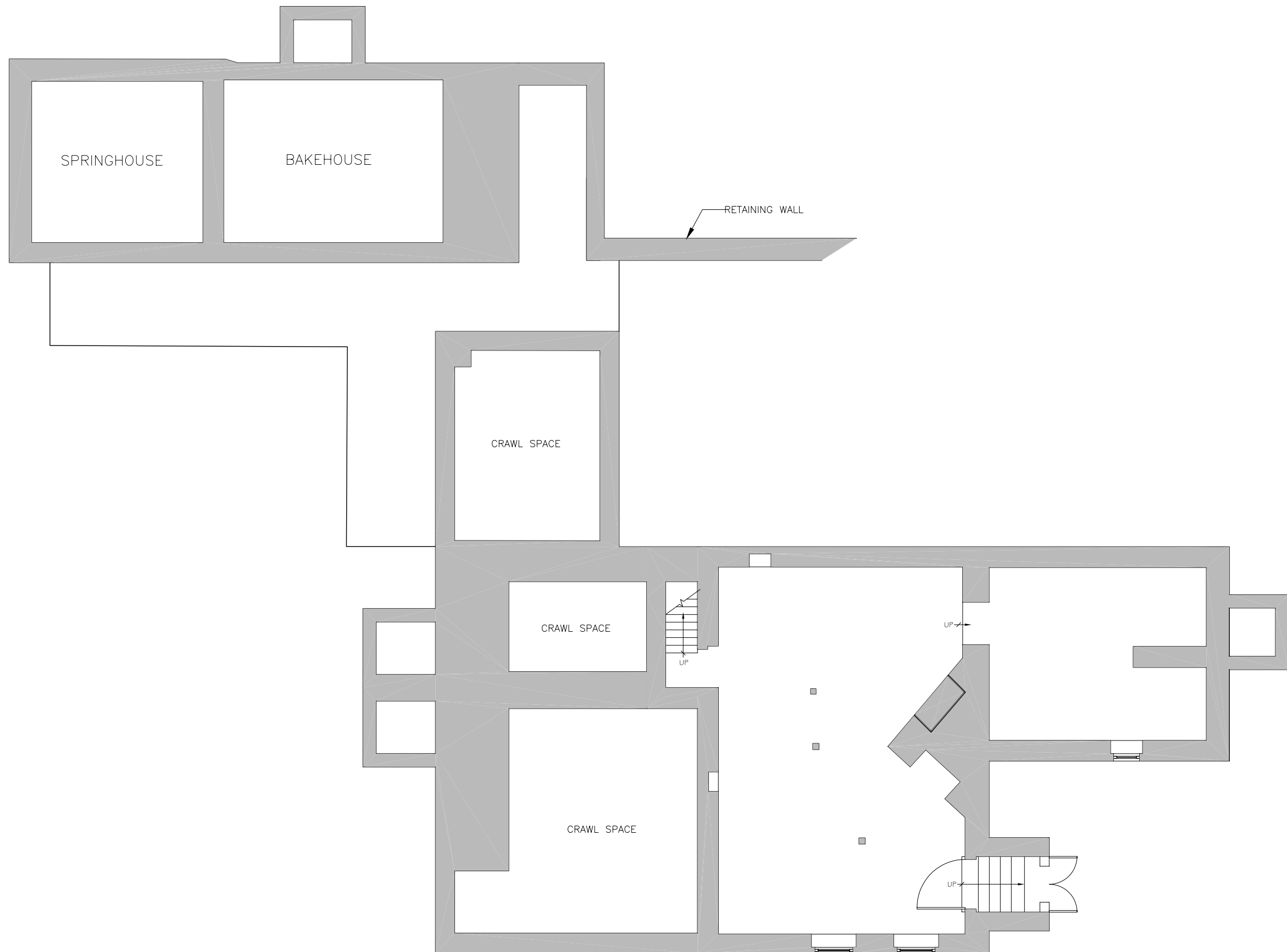


Historic Structure Report  
**STIRLING'S QUARTERS**  
Valley Forge National Historical Park

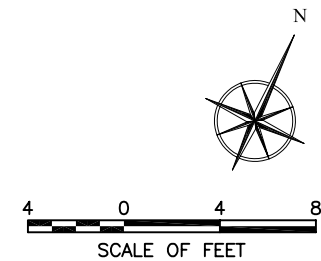
**JOHN MILNER ARCHITECTS, inc.**  
104 Lakeview Drive, Chadds Ford, Pennsylvania 19317 • (610) 388-0111

BUILDING  
CHRONOLOGY

EAST  
ELEVATION  
1926



BASEMENT PLAN — 1926



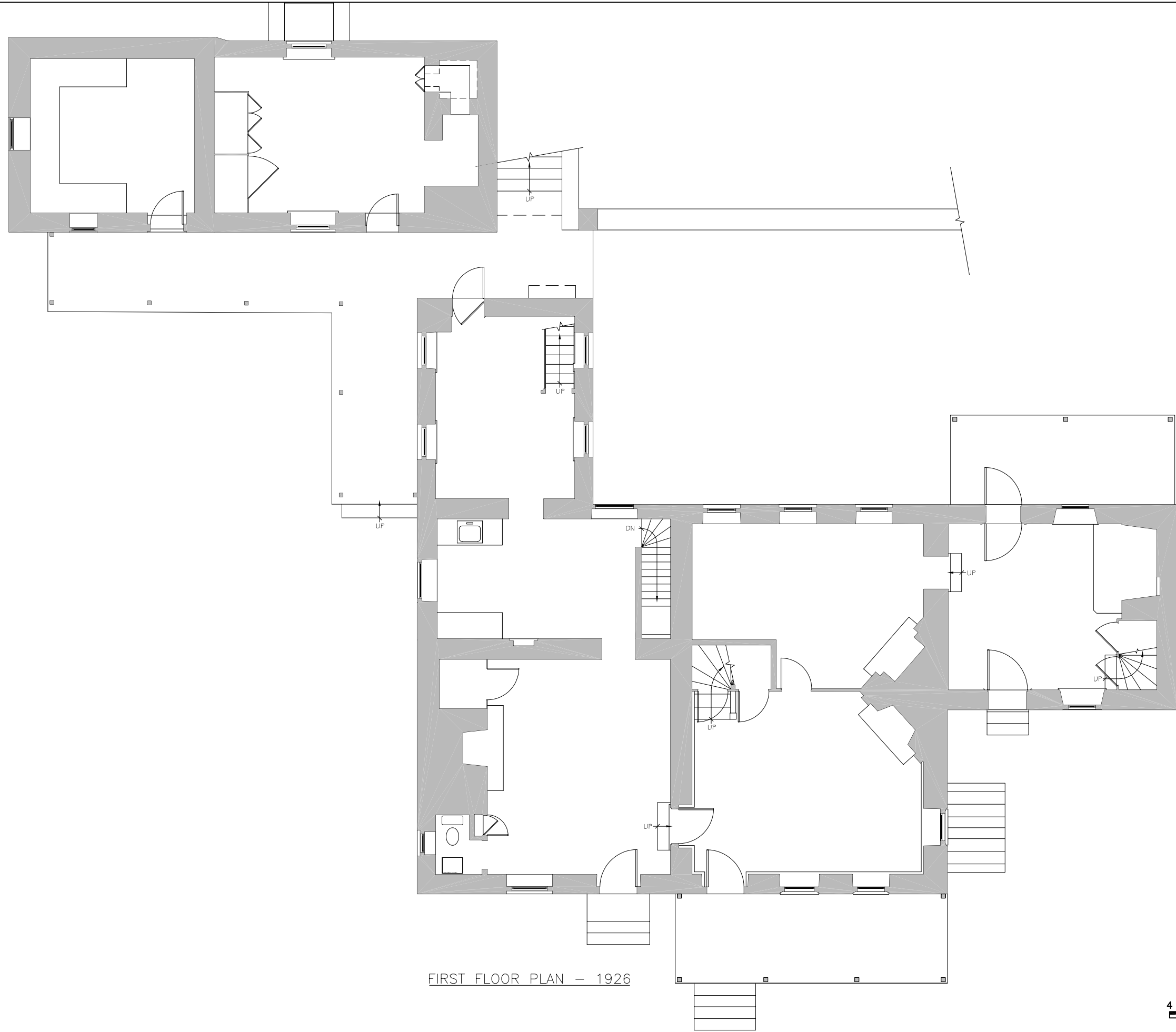
Copyright 2005 John Milner Architects, Inc.

Historic Structure Report  
**STIRLING'S QUARTERS**  
 Valley Forge National Historical Park  
**JOHN MILNER ARCHITECTS, inc.**  
 104 Lakeview Drive, Chadds Ford, Pennsylvania 19317 • (610) 388-0111

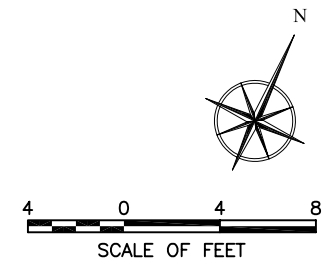
BUILDING  
 CHRONOLOGY

BASEMENT  
 PLAN  
 1926





FIRST FLOOR PLAN - 1926

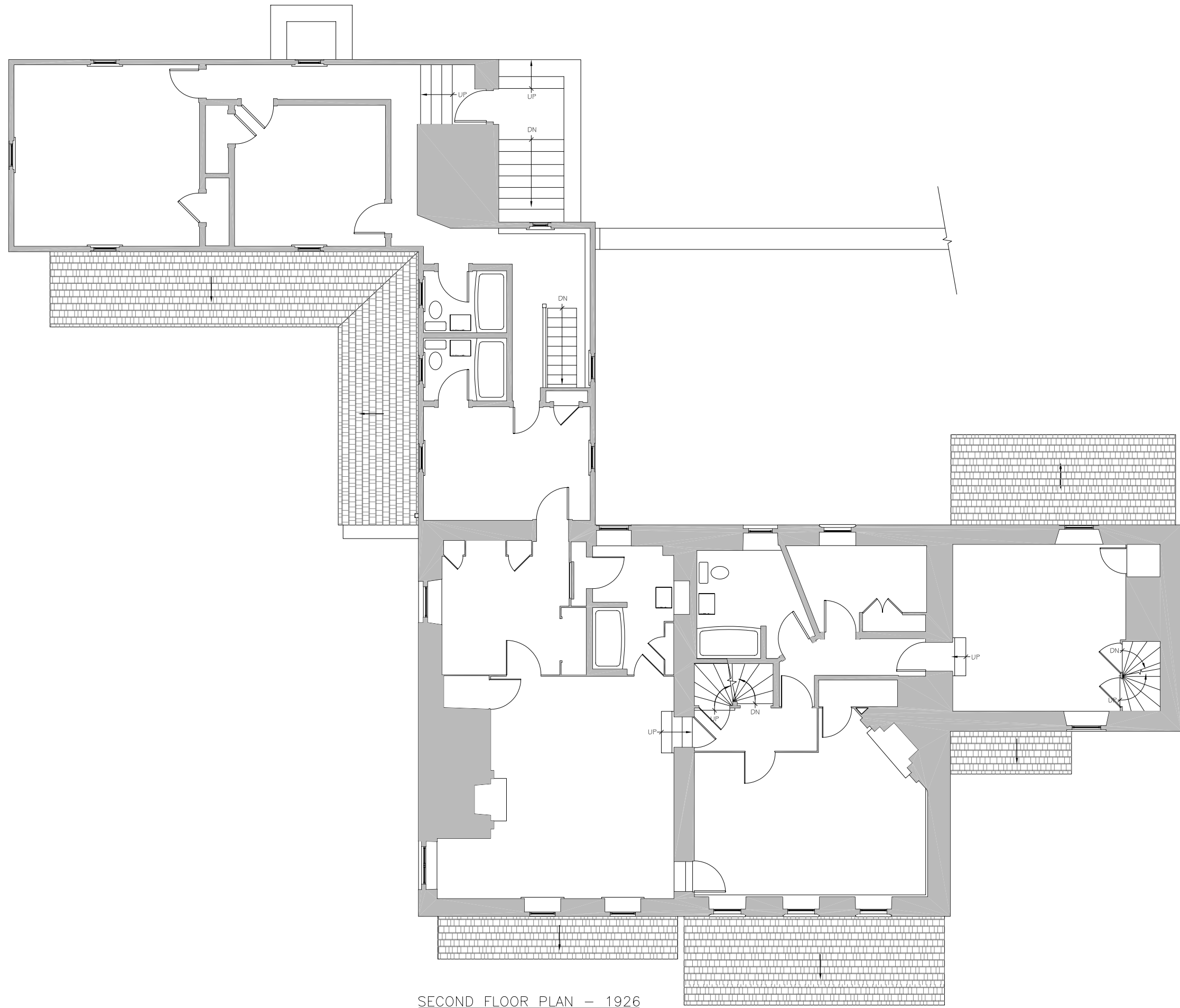


Historic Structure Report  
**STIRLING'S QUARTERS**  
 Valley Forge National Historical Park

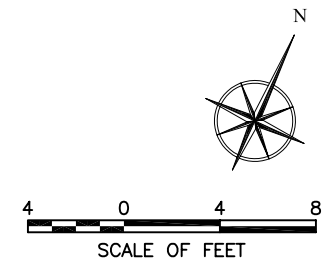
**JOHN MILNER ARCHITECTS, inc.**  
 104 Lakeview Drive, Chadds Ford, Pennsylvania 19317 • (610) 388-0111

BUILDING  
 CHRONOLOGY

FIRST FLOOR  
 PLAN  
 1926



SECOND FLOOR PLAN — 1926

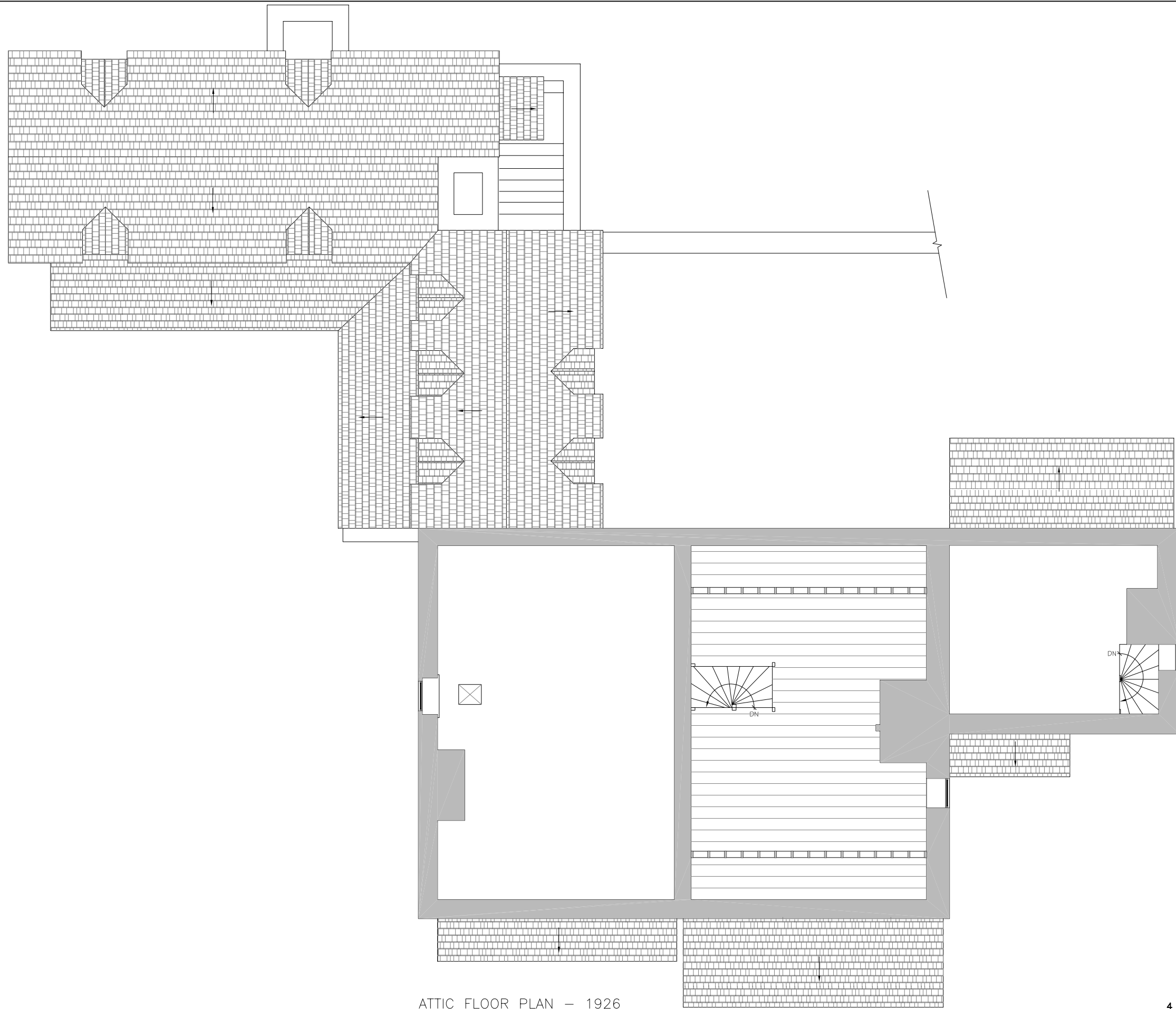


Historic Structure Report  
**STIRLING'S QUARTERS**  
 Valley Forge National Historical Park

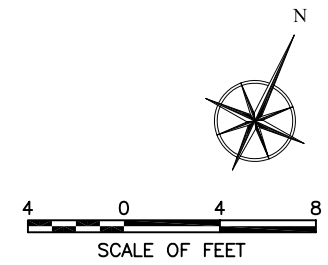
**JOHN MILNER ARCHITECTS, inc.**  
 104 Lakeview Drive, Chadds Ford, Pennsylvania 19317 • (610) 388-0111

BUILDING  
 CHRONOLOGY

SECOND  
 FLOOR PLAN  
 1926



ATTIC FLOOR PLAN - 1926



Historic Structure Report  
**STIRLING'S QUARTERS**  
 Valley Forge National Historical Park

**JOHN MILNER ARCHITECTS, inc.**  
 104 Lakeview Drive, Chadds Ford, Pennsylvania 19317 • (610) 388-0111

BUILDING  
 CHRONOLOGY

ATTIC  
 FLOOR PLAN  
 1926

**APPENDIX B**  
**NATIONAL REGISTER OF**  
**HISTORIC PLACES**  
**NOMINATION FORM**



NATIONAL REGISTER OF HISTORIC PLACES  
INVENTORY - NOMINATION FORM

(Type all entries - complete applicable sections)

STATE:
COUNTY:
FOR NPS USE ONLY
ENTRY DATE

**1. NAME**

COMMON: Major-General Lord Stirling's Quarters

AND/OR HISTORIC: "Homestead Farm" (1880) "Echo Valley Farms" (1926-1973)

**2. LOCATION**

STREET AND NUMBER: Yellow Springs Road

CITY OR TOWN: Treddyffrin CONGRESSIONAL DISTRICT: Fifth District

STATE: Pennsylvania CODE: 42 COUNTY: Chester CODE: 029

**3. CLASSIFICATION**

CATEGORY (Check One)	OWNERSHIP	STATUS	ACCESSIBLE TO THE PUBLIC
<input type="checkbox"/> District <input type="checkbox"/> Site <input type="checkbox"/> Object <input checked="" type="checkbox"/> Building <input type="checkbox"/> Structure <input type="checkbox"/> Public <input checked="" type="checkbox"/> Private <input type="checkbox"/> Both	Public Acquisition: <input type="checkbox"/> In Process <input type="checkbox"/> Being Considered	<input type="checkbox"/> Occupied <input checked="" type="checkbox"/> Unoccupied <input type="checkbox"/> Preservation work in progress	Yes: <input checked="" type="checkbox"/> Restricted <input type="checkbox"/> Unrestricted <input type="checkbox"/> No

PRESENT USE (Check One or More as Appropriate)

<input type="checkbox"/> Agricultural	<input type="checkbox"/> Government	<input type="checkbox"/> Park	<input type="checkbox"/> Transportation	<input type="checkbox"/> Comments
<input type="checkbox"/> Commercial	<input type="checkbox"/> Industrial	<input type="checkbox"/> Private Residence	<input type="checkbox"/> Other (Specify)	
<input type="checkbox"/> Educational	<input type="checkbox"/> Military	<input type="checkbox"/> Religious		
<input type="checkbox"/> Entertainment	<input type="checkbox"/> Museum	<input type="checkbox"/> Scientific		

**4. OWNER OF PROPERTY**

OWNER'S NAME: Robert C. Ligget, Trustee of the Robert C. Ligget Trust

STREET AND NUMBER: Yellow Springs Road Box 97

CITY OR TOWN: Valley Forge STATE: Pennsylvania CODE: 42

**5. LOCATION OF LEGAL DESCRIPTION**

COURTHOUSE, REGISTRY OF DEEDS, ETC.: Chester County Courthouse (Recorder of Deeds)

STREET AND NUMBER: High Street

CITY OR TOWN: West Chester STATE: Pennsylvania CODE: 42

**6. REPRESENTATION IN EXISTING SURVEYS**

TITLE OF SURVEY: Historic Zoning Ordinance, Treddyffrin Township (Bldg. #1)

DATE OF SURVEY: 1966  Federal  State  County  Local

DEPOSITORY FOR SURVEY RECORDS: Township Building

STREET AND NUMBER: 973 Old Lancaster Road

CITY OR TOWN: Beryn STATE: Pennsylvania CODE: 42

SEE INSTRUCTIONS

STATE: COUNTY: ENTRY NUMBER: DATE:

FOR NPS USE ONLY

7. DESCRIPTION

CONDITION

(Check One)					
<input checked="" type="checkbox"/> Excellent	<input type="checkbox"/> Good	<input type="checkbox"/> Fair	<input type="checkbox"/> Deteriorated	<input type="checkbox"/> Ruins	<input type="checkbox"/> Unexposed
(Check One)			(Check One)		
<input checked="" type="checkbox"/> Altered	<input type="checkbox"/> Unaltered	<input type="checkbox"/> Moved	<input checked="" type="checkbox"/> Original Site		

DESCRIBE THE PRESENT AND ORIGINAL (if known) PHYSICAL APPEARANCE

The Quarters of Lord Stirling was constructed in three sections. Tax records, wills, and deeds indicate that buildings, gardens, and orchards were established prior to 1739. It is possible that Henry John who purchased 100 acres in 1715 from the original tract of 1000, established the west section as a one story, one room structure. The center structure has been dated at 1769 and is credited to William Curie who purchased the farm in 1767. Thomas Walker who acquired the property in 1791 may have constructed the "new" kitchen mentioned in his will of 1835.

Sometime in the nineteenth century the west side was deepened into two rooms and the roof raised to accommodate a full second story.

The three structures were constructed of stone and faced with plaster. All structures included a medium height gable roof. The center section was three bays with a covered front porch. Chimney placement is on the east wall. Second floor windows were six over six double hung while the first floor windows were nine over six double hung. The front door is eight, raised panel. A small four light attic window is the only opening in the west wall.

The west section is two bays with a pent eve. Both first and second floor windows were six over six double hung. Chimney placement is in the west wall as well as a small four light window on the second floor. An attic window opening in the west wall is also evident.

The east section includes two bays and pent eve. The windows were six over six double hung. The chimney placement was in the east wall along with a small four light attic window.

Prior to 1926 windows were added in the west front and central and west rear. Sometime in the Nineteenth century a mantel of Federal design covered the walkin fireplace in the west front room. In the three sections, each served by boxed stairs, were five second floor rooms and a hallway, as well as five first floor rooms. There were back to back corner fireplaces in the two central rooms, two cooking fireplaces, as well as raised panel wall covering.

In 1926 the structure was renovated under the direction of Boyle Irwin. Additions on the first floor included; a powder room installed in the stair closet of the west front room; a bathroom and a linen room constructed in the rear central chamber and a bath and study built into the rear west chamber. Three windows were added in the west gable and the original four light window was removed and the opening enlarged. The corner fireplaces received new mantels; new flooring was put in the west addition; stair closets in the cellar of the east and central sections were converted to storage closets. Restoration hardware was installed and the raised panel woodwork painted. On the north side of the west gable a chimney and the fireplace it served were removed and a new kitchen installed. From the rear wall of the west section a dormered addition was constructed to connect the outbuilding which stood to the north some twenty feet. The roof of the bakehouse-springhouse complex was raised to provide new quarters in this area. The enclosed entry on the front porch was added in the nineteen thirties.

SEE INSTRUCTIONS



8. SIGNIFICANCE

PERIOD (Check One or More as Appropriate)

- Pre-Columbian       16th Century       18th Century       20th Century  
 15th Century       17th Century       19th Century

SPECIFIC DATE(S) (If Applicable and Known)

AREAS OF SIGNIFICANCE (Check One or More as Appropriate)

- |  |  |   |  |
|--|--|---|--|
| <input type="checkbox"/> Aboriginal              | <input type="checkbox"/> Education           | <input type="checkbox"/> Political      | <input type="checkbox"/> Urban Planning  |
| <input type="checkbox"/> Prehistoric             | <input type="checkbox"/> Engineering         | <input type="checkbox"/> Religion/Phi-  | <input type="checkbox"/> Other (Specify) |
| <input checked="" type="checkbox"/> Historic     | <input type="checkbox"/> Industry            | losophy                                 | _____                                    |
| <input type="checkbox"/> Agriculture             | <input type="checkbox"/> Invention           | <input type="checkbox"/> Science        | _____                                    |
| <input checked="" type="checkbox"/> Architecture | <input type="checkbox"/> Landscape           | <input type="checkbox"/> Sculpture      | _____                                    |
| <input type="checkbox"/> Art                     | Architecture                                 | <input type="checkbox"/> Social/Human-  | _____                                    |
| <input type="checkbox"/> Commerce                | <input type="checkbox"/> Literature          | itarian                                 | _____                                    |
| <input type="checkbox"/> Communications          | <input checked="" type="checkbox"/> Military | <input type="checkbox"/> Theater        | _____                                    |
| <input type="checkbox"/> Conservation            | <input type="checkbox"/> Music               | <input type="checkbox"/> Transportation | _____                                    |

STATEMENT OF SIGNIFICANCE

Stirling's Quarters includes both architectural and historical significance.

Architecturally the entire site displays an excellent example of an Eighteenth century farm complex. Evolving from a one room, one story house plan, the rambling additions mark the entire evolution of a Eighteenth century mid-Atlantic Farm. When the structure was renovated care was taken not to destroy the historical character of the site. Where rooms were changed or added the changes were carried out within the limitations of the early proportions. Remaining are the two stair closets, cooking fireplaces, early doors and windows, moulded chair-rails, wainscot, original boards as well as a bakehouse, springhouse, and an unidentified bank outbuilding.

General Stirling was noted as a general in Washington's army and occupied this structure during the 1777-78 winter at Valley Forge. Stirling also achieved fame in Washington's Campaign in New York as well as the Battle Of Brandywine.

The significance of Stirling's Quarters lies in its historical role in the American revolution as well as its study of early Pennsylvania farm life.

SEE INSTRUCTIONS

9. MAJOR BIBLIOGRAPHICAL REFERENCES

Pinkowski, Edward Washington's Officers Slept Here, Sunshine, Phila. 1953, pp. 99-105.

Valentine, Alan Lord Stirling, Oxford, 1969, p. 23.

-----"Valley Forge Landmarks", Stepehn Moylan Press, 1958, p.24.

10. GEOGRAPHICAL DATA

LATITUDE AND LONGITUDE COORDINATES DEFINING A RECTANGLE LOCATING THE PROPERTY			O R	LATITUDE AND LONGITUDE COORDINATES DEFINING THE CENTER POINT OF A PROPERTY OF LESS THAN TEN ACRES		
CORNER	LATITUDE	LONGITUDE		LATITUDE	LONGITUDE	
NW	Degrees Minutes Seconds 40 ° 05 ' 06 "	Degrees Minutes Seconds 75 ° 27 ' 52 "		Degrees Minutes Seconds ° ' "	Degrees Minutes Seconds ° ' "	
NE	40 ° 05 ' 06 "	75 ° 27 ' 43 "				
SE	40 ° 05 ' 01 "	75 ° 27 ' 43 "				
SW	40 ° 05 ' 01 "	75 ° 27 ' 52 "				

APPROXIMATE ACREAGE OF NOMINATED PROPERTY: 10 Acres

LIST ALL STATES AND COUNTIES FOR PROPERTIES OVERLAPPING STATE OR COUNTY BOUNDARIES

STATE:	CODE	COUNTY	CODE
STATE:	CODE	COUNTY:	CODE
STATE:	CODE	COUNTY:	CODE
STATE:	CODE	COUNTY:	CODE

11. FORM PREPARED BY

NAME AND TITLE:

David C. Stacks, Student Aide

ORGANIZATION

Historic Sites Survey, Pa. Historical & Museum Commission

DATE

6/15/73

STREET AND NUMBER:

Box 1026

CITY OR TOWN:

Harrisburg

STATE

Pennsylvania

CODE

42

12. STATE LIAISON OFFICER CERTIFICATION

NATIONAL REGISTER VERIFICATION

As the designated State Liaison Officer for the National Historic Preservation Act of 1966 (Public Law 89-665), I hereby nominate this property for inclusion in the National Register and certify that it has been evaluated according to the criteria and procedures set forth by the National Park Service. The recommended level of significance of this nomination is:

National  State  Local

Name

William J. Wewer  
William J. Wewer

Title

Executive Director, Pa. Historical and Museum Commission

Date

11/8/73

I hereby certify that this property is included in the National Register.

\_\_\_\_\_  
Director, Office of Archeology and Historic Preservation

Date

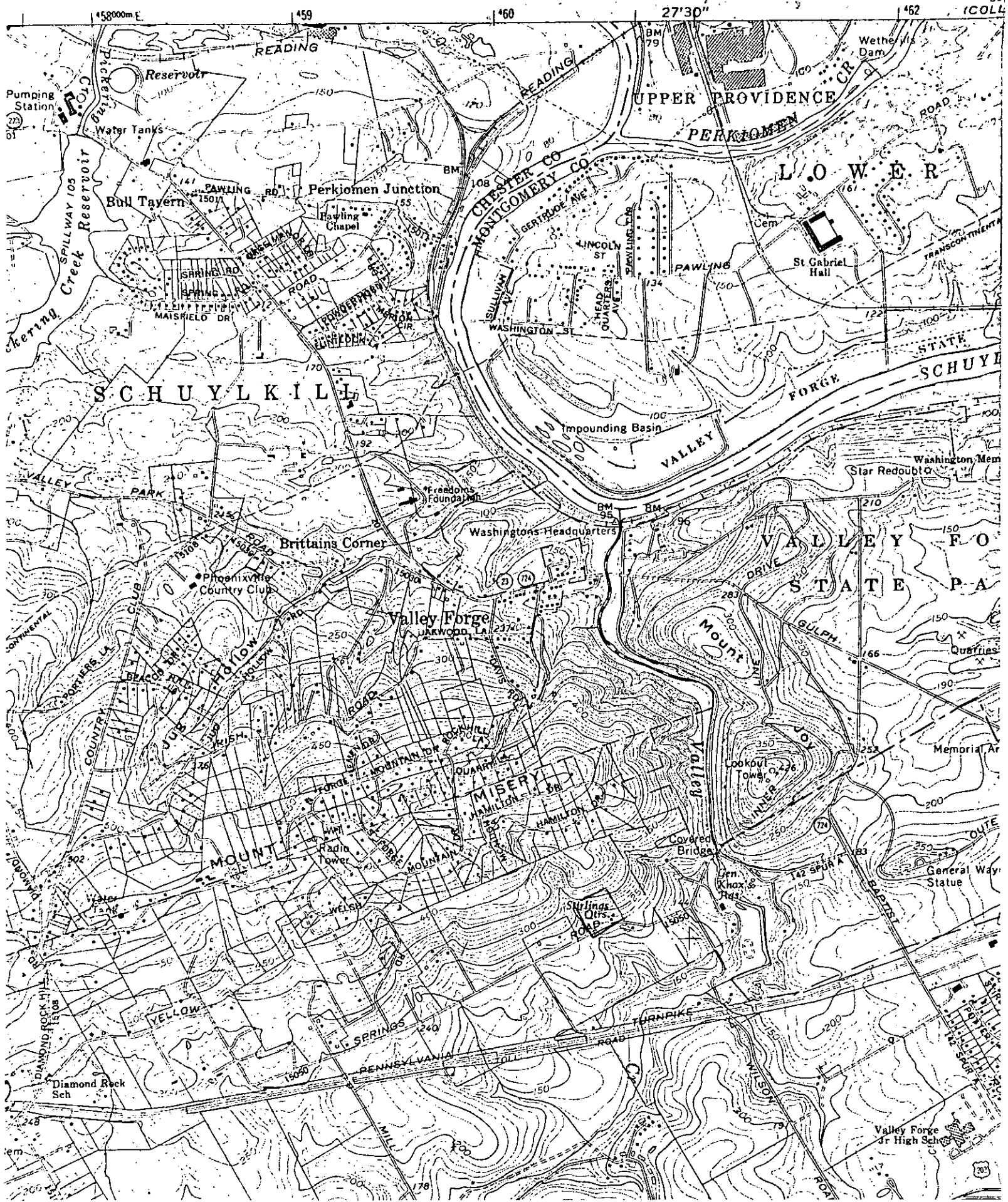
ATTEST:

\_\_\_\_\_  
Keeper of The National Register

Date

SEE INSTRUCTIONS

Major Gen. Stirling's Quarters



**APPENDIX C**  
**CHAIN OF TITLE**



**CHAIN OF TITLE - STIRLING'S QUARTERS  
VALLEY FORGE NATIONAL HISTORICAL PARK, VALLEY FORGE, PENNSYLVANIA**

Date of Deed:	Date Recorded:	Grantor:	Grantee:	Acreage:	Deed Book:	Vol:	Page:
22 Feb 1978	26 Apr 1978	Frances H. Liggett & Audrey L. Snyder et. al, Co-Trustees	United States of America Valley Forge National Historical Park	65.49 acres	T52		393
14 Sep 1934 Deed of Trust	25 Sep 1934	Ethel M. Ellison, Trustee	Robert C. Liggett, Trustee	130.061 acres	T18	441	13
14 Sep 1934 Deed of Trust	25 Sep 1934	Robert C. Liggett & Frances H. Liggett	Ethel M. Ellison, Trustee	130.061 acres	T18	441	8
07 Jan 1926	14 Jan 1926	Pedro G. Salom & Julia A. Salom	Robert C. Liggett & Frances H. Liggett	130.061 acres	Z16	397	208
30 Sep 1899	06 Oct 1899	Henry L. Evans & Mary E. S. Evans	Pedro G. Salom	130.061 acres	E11	252	293
16 Apr 1880	21 Apr 1880	William S. Walker, et al. Executors of Joseph B. Walker	Henry L. Evans	163 acres 33 perches	G9	204	423
8 Jul 1835 Last Will & Testament		Thomas Walker	Joseph B. Walker	200 acres ±	Estate File No. 9829		
25 Oct 1791	18 Feb 1792	William Currie	Thomas Walker	200 acres ±	G2	31	53
<hr/>							
28 May 1767 Sheriff Sale	28 Sep 1767	John Morton, Esq. High Sheriff, County of Chester	William Currie	176 acres	P	15	132
31 July 1753 Last Will & Testament		Griffith John	Thomas John	176 acres	Estate File No. 1510		
13 May 1740 Patent	9 Aug 1740	John Penn, Thos. Penn & Richard Penn, Esquires Proprietaries of Pennsylvania	Griffith John	176 acres	Patent A	10	111
<hr/>							
28 May 1767 Sheriff Sale	26 Sep 1767	John Morton, Esq. High Sheriff, County of Chester	William Currie	100 acres	P	15	129
08 Dec 1752	6 Jan 1774	Griffith Jones (Griffith John)	Thomas Jones (Thomas John)	100 acres	S	18	350
20 Nov 1739	5 Jan 1774	Henry John	Griffith Jones (Griffith John)	100 acres	S	18	349
24 Dec 1714	5 Jan 1774	David Powell	Henry John	100 acres	S	18	348
15 Nov 1706		David Meredith	David Powell	1340 acres			
16 Apr 1706 Patent	8 May 1706	William Penn	David Meredith	1340 acres	Patent A	3	270

**APPENDIX D**  
**STRUCTURAL ENGINEER**  
**LETTER REPORT -**  
**GREDELL & ASSOCIATES**







February 8, 2005

Chris Carter, AIA  
John Milner Architects, Inc.  
104 Lakeview Drive  
Chadds Ford, PA 19317

WO 554.132  
STIRLING'S QUARTERS  
VALLEY FORGE NATIONAL HISTORIC PARK

Chris:

We have completed our field review of the floor and roof framing of the referenced building and have prepared this letter engineering report to summarize our findings and recommendations regarding their structural condition. Italicized font is used as a means of highlighting the recommendations. The review consisted of visual observations and selective probing of those portions of the structure which were safely accessible without the use of staging or uncovering.

We understand that the Park Service is presently considering leasing buildings such as this one to generate additional income for maintenance. A concern in this regard is that the buildings are structurally sound and the strength of the floor framing is adequate to support at least the minimum live load requirements imposed by good practice and the building code for the intended use. The following table provides a summary of the minimum uniformly distributed floor loading for various uses recommended by the building code:

<u>Occupancy or use</u>	<u>Live load (PSF)</u>
Residences	
First floor	40
Second floor and habitable attics	30
Uninhabitable attics	20
Offices	50

Attached to this report are sketches of the framing plans for the floors and roof of this building. In addition to the framing configuration, we have included the allowable uniformly distributed live loading for each level with regard to both strength and stiffness of the framing members. For strength we have assumed that the original building material meets the current day requirements for "select structural" with an allowable extreme fiber bending stress and elastic modulus of 2000 PSI and 1,600,000 PSI, respectively. For the reframed roofs the hem-fir No.2 lumber has an allowable bending stress of approximately 875 PSI. The "stiffness" criteria (indicated by the graphic delta) that is provided applies

to framing to which is attached plaster finishes. This includes second and third floor framing only since neither basements or attics are finished in this building. Based on good practice, the allowable live load deflection of the framing that supports plaster is limited to  $1/360^{\text{th}}$  of the span. Greater deflection or "bounce" in the floors tends to reduce the service life of the plaster finishes.

The building is a residential structure which faces south and is comprised of three blocks: The original block constructed circa 1769 is a three bay, double ply, 2 ½ story stone masonry residence constructed over a full basement. To the west of the main block is the



original kitchen, constructed with the main block in 1769 and an addition to the north of the kitchen built circa 1810. The western stone masonry gable end wall of the original kitchen block was vertically expanded to accommodate the addition. Located on the east side of the original block is a two story, single ply addition constructed over a full basement. We have attached to this report engineer's sketches that

provide the plan form of the building as described above and the framing that was observed.

### Original 1769 Block

The building which measures in plan approximately 32' north-south by 24' east-west is built over a full basement and rises on uncoursed, rubble stone walls 2 ½ stories to a gable form roof. The first floor is framed with 3x7 joists set at 26" centers and spanning north-south, bearing on the exterior masonry walls and flush framed to a central timber summer beam spanning east-west. The joist spans are asymmetric; 13' north and 15'



south. For the longer span a more recent 8x8 timber beam (east-west) underframes the floor joists; halving the spans and therefore stiffening the floor. The primary, central beam is supported by the foundation for the corner fireplaces and chimney mass (east) a central 6x6 post and the exterior west wall of the block. The first floor farming is in poor condition with approximately half the joists partially consumed by termite infestation. Both the diagonal running hearth headers are in poor condition. The central summer beam is severely checked and the central post is set into the concrete floor where damp is a concern with regard to serviceability.

*Carefully remove the flooring, rotten joists and diagonal hearth headers. Consider two options: replacing the members in kind or reframe the floor with double 2x8 pressure treated, "select structural" members set into the original wall pockets and supported by metal framing connectors. Repair the severe check in the summer beam with a combination of epoxy and stitch bolting. Damp proof the bottom of the post. In addition, the timber lintel at the passage to the east addition is rotten and requires replacement.*

The framing of the second and third floor is provided by 3x7 joists set at approximately 20" centers spanning north south. An east- west running summer beam, positioned 2' north of the geometric center of the building, is concealed at both levels. At the third level on the south side, the joists are dressed with chamfered corners. The framing appears to be in good structural condition. The allowable tributary live loading for the floor is limited by the deflection of the joists on the south side to 36 PSF. This is without consideration of the summer beam which is concealed and therefore the capacity is unknown.

The gable form roof structure of the block has been reframed with 2x6 rafters set at 2' centers supported by collar members bearing on a manufactured timber beam (3) 1<sup>3</sup>/<sub>4</sub> LVL 11 7/8 spanning east-west. The allowable uniformly distributed live loading on this reframed roof is only 5 PSF, which is considerably less than the minimum loading recommended by the building code of 15 PSF.

*The capacity of the roof may be enhanced by sistering the rafters and installing diagonal bracing (tied at the bottom) to decrease the span on the east-west roof beam.*

### **West block -1769 kitchen / 1810 addition**

The first floor framing installed over a shallow crawl space is comprised of 8" diameter tree joists spanning north-south and bearing on the exterior masonry walls and an interior row of central piers formed from dry stack stones. The joists are in poor condition with extensive termite damage; especially at the south end adjacent to the bearings. The 9x8 hearth header has very little section remaining due to the extent of the infestation. The original framing configuration with the piers in place provided enough strength



to support a uniformly distributed live load of approximately 300PSF. There is no need to provide for such a high loading in the repaired structure.

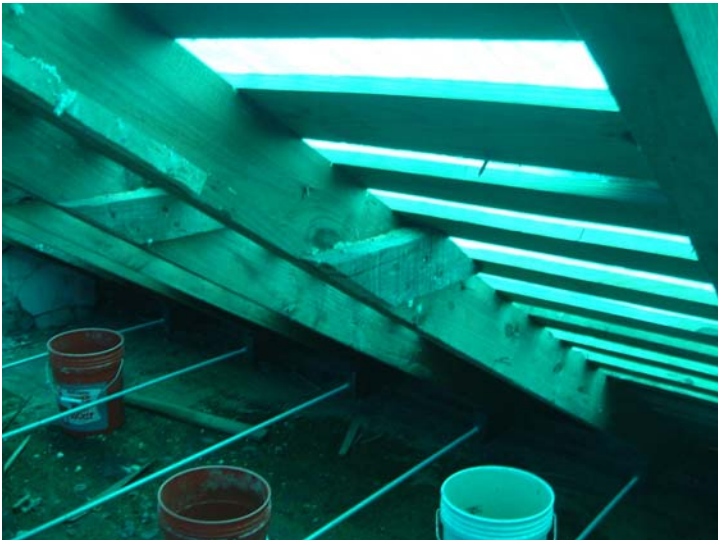
*Provide ventilation and damp proofing of the crawl space. Replace the stone piers with concrete masonry set on new footings and reframe the floor with pressure treated timber of similar section to the tree joists so that masonry bearings can be reused.*

In the 1810 addition of this block, the plan form measures about 12' north-south by 20' east-west. The remains of the joists have been removed from the building. Based on some remaining evidence at the northwest corner of the first level, it appears that the framing consisted of 3x8 joists spanning north-south and bearing on the masonry walls. These members could safely support a tributary live loading of 140 PSF.

*Since it would be difficult to provide adequate ventilation in this area without excavating which would cause concern regarding the undermining of the exterior wall foundation, damp proofing and subsequently casting a slab on grade with wood sleepers and wood deck may be the best approach for restoring the floor structure in this addition.*

The floor framing of the second and third levels of this block appears in good condition – 3x7 at 28" centers in the 1769 section and 3x8 at 21" in the 1810 addition. Noteworthy is that the second floor joists in the 1769 addition are visually enhanced with beaded corners. Strength is not an issue for the floor framing in the 1810 addition; however, in the 1769 section, the allowable safe live loading for the floor is limited by strength to 21 PSF. At the third level the joists at the south span are chamfered to improve the exposed appearance. The capacity of the third floor is limited by stiffness to 26 PSF.

*The joists at both levels 2 and 3 are in good condition with no repairs needed. In the event a greater capacity for floor loading is required, the joists at all levels can be strengthened by sistering; however, decorative chamfers and beads would be concealed by ceiling finishes that would be needed to cover the unsightly sistering work.*



The roof of this addition has been reframed with 2x6 rafters placed at 24" centers; tied at the bottom by a 3/4" diameter threaded rod and coupled to the base of the rafter with a bolted steel plate connector. The allowable uniformly distributed live (snow) load capacity of the roof structure is 4 PSF. This matches the allowable loading of the original block which is considered not adequate; meeting only 1/3 of the minimum recommended by the

building code. The threaded rod tie and connector assembly is sufficiently strong enough to address the thrusting at the base of the rafter under code recommended snow loading. *Sister the rafters in order to provide the required strength. As an option to the threaded rod ties, a structural ridge could be provided by a lightweight east-west attic truss.*



### **1830 east addition**

Constructed of uncoursed, rubble stone masonry this addition rises two levels over a full basement. The first floor is framed with 3x8 joists at 21" centers spanning north-south and bearing on the exterior masonry. Termite damage is prevalent here, similar to the condition of the first floor throughout the building. At least 3 of the joists have been consumed by termite infestation. Provided the joists are replaced with similar section and strength, the allowable live loading would be approximately 100 PSF.

*Replace the deteriorated framing with pressure treated members of similar section.*

Second and third floor framing is in good structural condition – 3 ½ x7 at 20" centers and 4x7 at 26" centers at the second and third floors, respectively. The allowable live loading at both floors is limited by the stiffness of the joists to approximately 50 PSF. No repairs are required for these members provided the allowable live loading meets the proposed programming requirements for the space.

Portions of the roof framing are concealed by insulation board that has become wet due to leaking of the temporary tarp covering the roof. Rafters that can be observed include a combination of 4" diameter tree rafters and 3x4 hewn members. Ridge connections are pinioned open mortise and tenon and appear to be original to the structure. They are the only original roof framing members found in the building.

In summary, the first floor framing is in poor condition due to a combination of moisture at the bearings and infestation by termites. Damaged and deteriorated timber, which approaches over half the original members, should be removed and the building be treated by a certified pest control firm to ensure that there is no termite activity in and around the building. The reframing of the first floor can be a restoration effort whereby the original framing sizes and joinery can be provided or alternately, conventional framing can be used to provide a floor structure that meets the proposed loading requirements of the floor. A decision must be made regarding the preferred method of addressing the structure of the first floor framing. Based on what has been previously done with regard to replacement of the rafters, it appears that replacement with conventional framing is an acceptable alternative.

The upper floors of the building are in good structural condition with the strength of the members meeting the live loading requirements for office use (50 PSF) except for the framing at the second floor above the 1769 kitchen and the third floor summer beam in the same block. The greatest limitation with regard to future use is the stiffness of the framing on the south side of the building at both the second and third levels of the building. Strengthening and stiffening can be provided by sistering; however, where the framing was originally exposed (chamfered and beaded corners) some decisions must be made regarding finishing of the ceilings. An additional concern is with regard to the capacity of the concealed summer beams at both the second and third levels of the original 1769 block. These members must be uncovered in order to determine their structural properties.

Except for the original roof framing of the 1830 addition located to the east of the original block, the roof framing is undersized with only 1/3 the recommended capacity for snow loading. We recommend that these members be reinforced by sistering prior to shingling the roof.

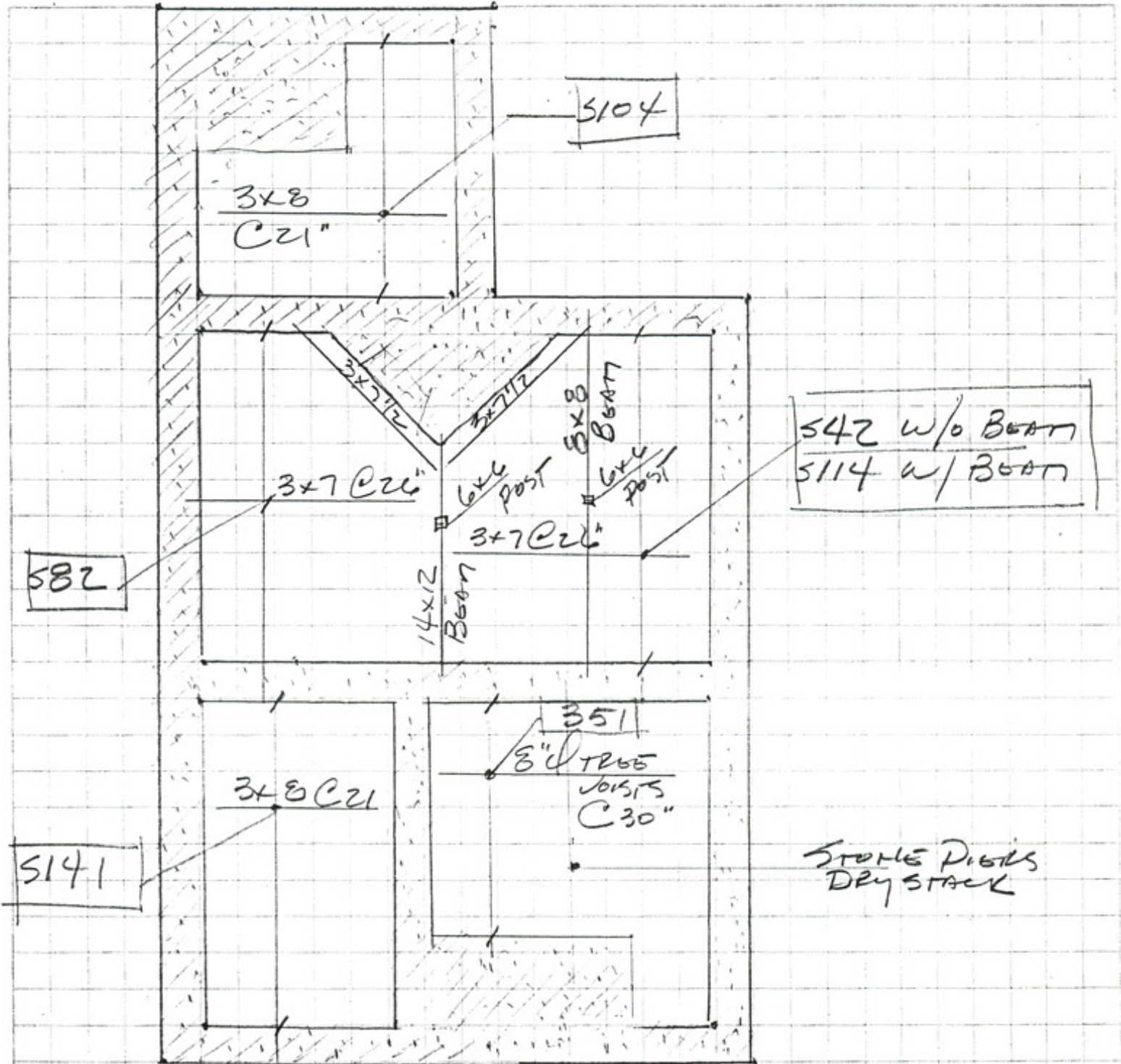
Once you have the opportunity to review the comments of this letter report, please call so that we might schedule a time to meet with you and members of the Park Service in order to discuss the recommendations of this report and to determine we might proceed with preparation of the construction documents for the recommended repairs.

GREDELL & ASSOCIATES

Gary W. Gredell, P.E.

Attachments: Engineers sketches sheets 1-4

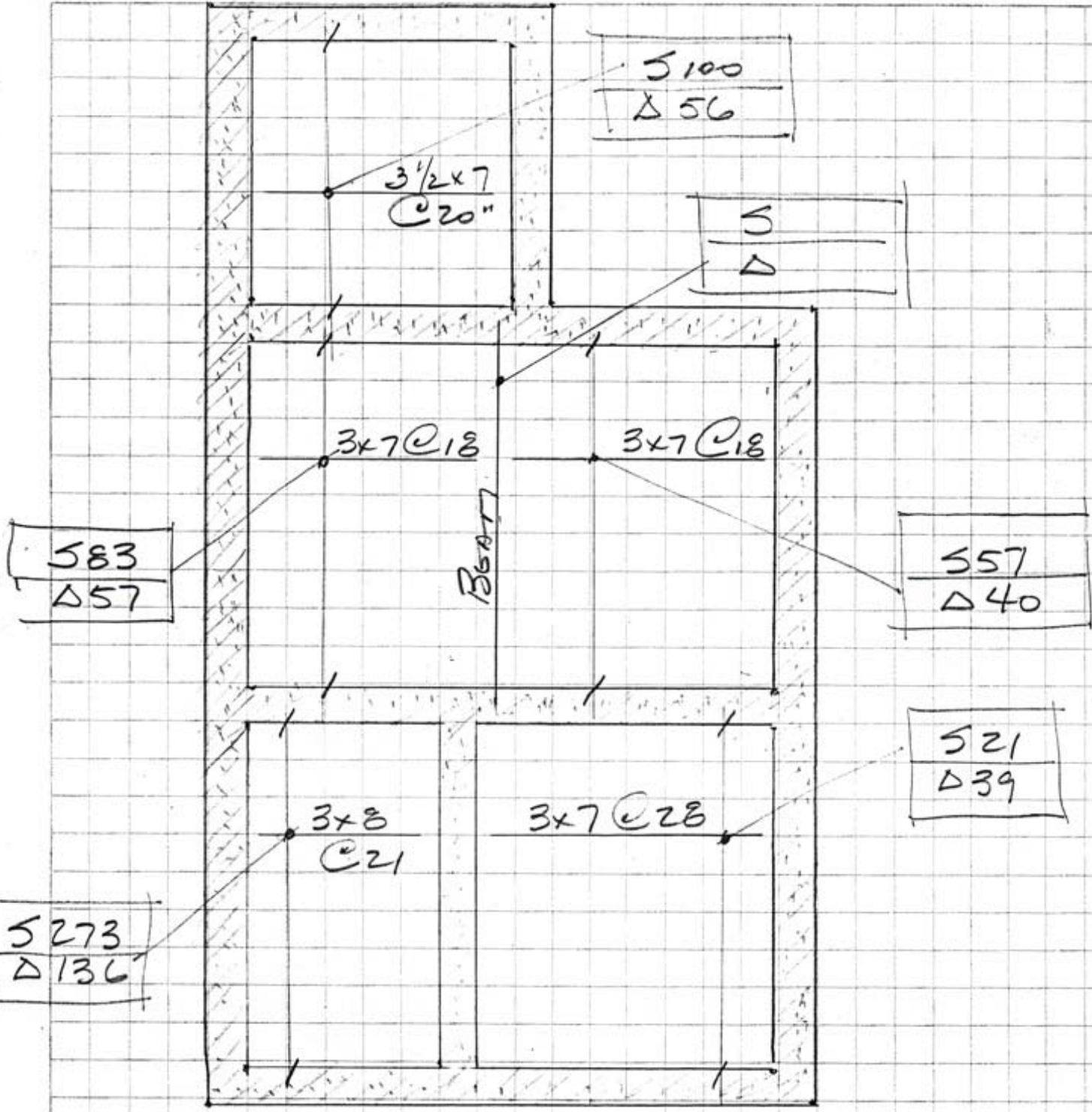




FIRST FLOOR FRAMING PLAN

1/8" = 1'-0"

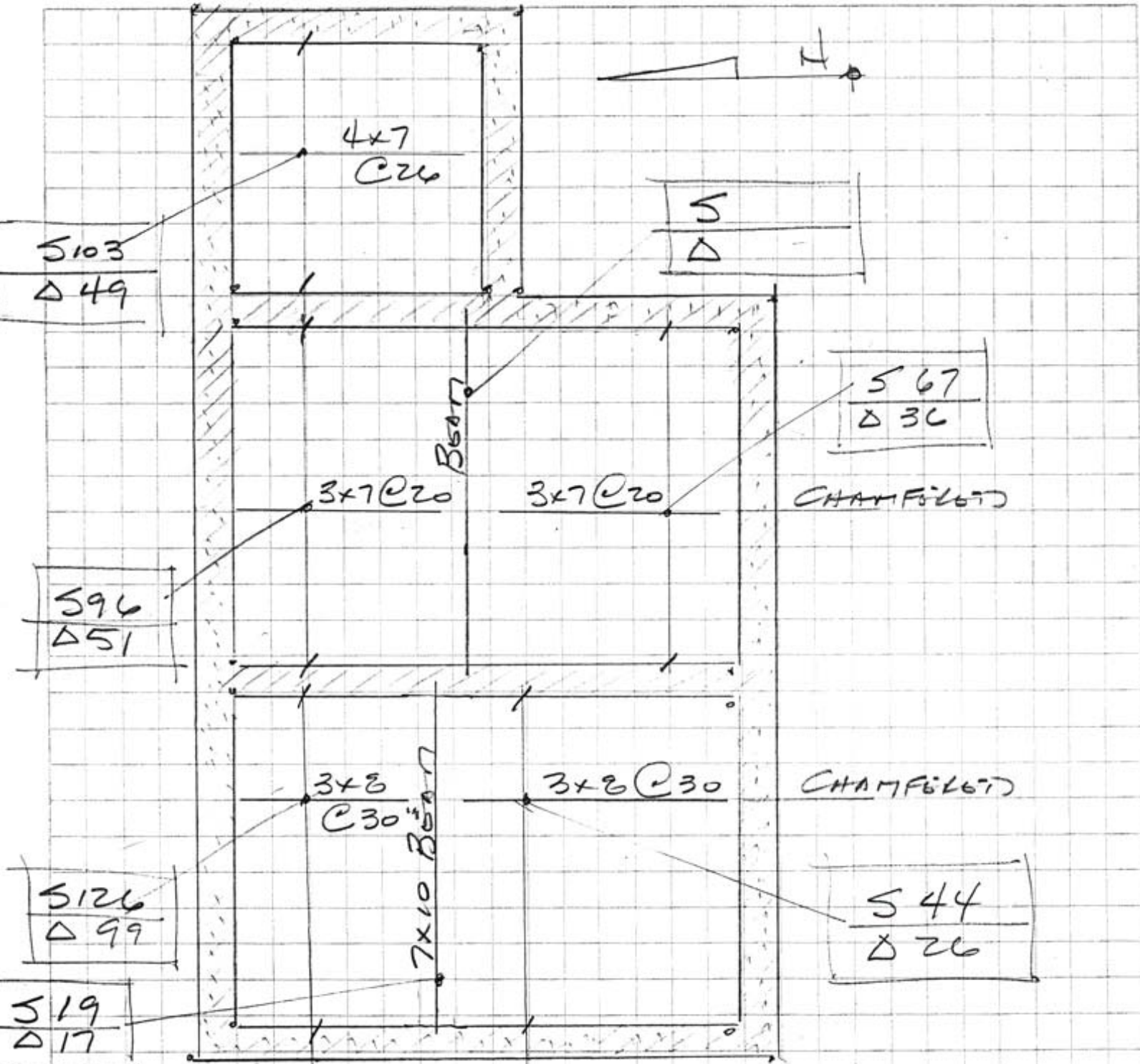
5 ALLOWABLE LIVE LOAD PSF - STRENGTH



SECOND FLOOR FLOORING PLAN  
1/8" = 1'-0"

S	ALLOWABLE LIVE LOAD	PSF - STRENGTH
Δ	"	PSF - DEFLECTION





3<sup>RD</sup> FLOOR FRAMING PLAN  
1/8" = 1'-0"

S ALLOWABLE LIVE LOADING PSF - STRENGTH  
Δ " " " " PSF - DEFLECTION



ROOF FRAMING PLAN  
1/8" = 1'-0"

5 AVAILABLE LIVE LOAD PSF - STRENGTH



July 25, 2005

Chris Carter, AIA  
John Milner Architects, Inc.  
104 Lakeview Drive  
Chadds Ford, PA 19317

WO 554.132  
1926 ADDITION  
STIRLING'S QUARTERS  
VALLEY FORGE NATIONAL HISTORIC PARK

Chris:

We have completed our structural review of the 1926 Addition to Stirling's Quarters. The findings of this review and recommendations for subsequent action are provided in this letter engineering report. The recommendations are highlighted with italicized font. For purposes of orientation, the addition is located north of the c.1810 kitchen addition. The review consisted of visual observations and selective probing of those portions of the structure which were safely accessible by ladder staging. Selective removal of plaster finishes enabled limited access to previously concealed floor framing. As discussed in our earlier report, dated February 8, 2005, the Park Service is considering the leasing of this building to generate income to offset the cost of future maintenance. Good practice and the minimum requirements of the Building Code suggest that the allowable uniformly distributed live loading for the floor structure is 40 PSF and 50 PSF for residential and office uses, respectively. Given the size of the floor areas we are presuming that partitioning would not be required. File cabinets should be limited to four drawer models that are not fire-proofed. Equipment or furnishings that impart heavy, concentrated floor loads should be placed at the first floor where slab on grade construction is provided.

Enclosed with this report are sketches which provide floor and roof framing plans for the building. In addition to the framing configuration, we have included the allowable uniformly distributed live loading for each level with regard to both strength and stiffness of the framing members. For strength, we have assumed that the original building material meets current day requirements for "select structural" with an allowable extreme fiber bending stress and elastic modulus of 2000 PSI and 1,600,000 PSI, respectively. Allowable unit shear stresses are 150 PSI assuming the section is unchecked. For the reframed roof, we have assumed the lumber to be hem-fir No.2 with an allowable bending stress of 875 PSI. The stiffness criteria (indicated by the graphic delta) that is provided applies to framing to which plaster finishes are attached. This includes the second floor and attic framing. Based on accepted practice, the allowable live load



deflection of the framing that supports the plaster is limited to  $1/360^{\text{th}}$  of the span. Greater deflection or "bounce" in the floors tends to reduce the service life of the plaster.

The 1926 addition is basically "L" shape in plan with the north-south leg attached to the northwest corner of the 1810 kitchen addition (see attached sketches) which is discussed in our previous report on the building. The other "leg" is oriented east-west. The plan form of the first level consists of two separate masonry blocks separated by an open passage approximately 4' in width. At second and roof levels, the construction is continuous. Both segments of the addition rise on thick stone masonry walls to a platform-framed, second level. The masonry is laid-up as uncoursed, stone rubble and appears to be in good condition. At the second level, the walls are framed in timber with clapboard siding. The walls rise to a gable form roof.

### First Floor

The first floor (south block) is framed with 3x8 joists set at 16" centers and spanning east-west over an earthen subgrade situated less than a foot below the bottom of the joists. The space below the framing is unventilated. Poor site drainage adjacent to the east wall of the block has caused wet conditions in the stone masonry. Finding favorable environment, termite infestation has consumed the eastern end of the joists.

*Regrading the site, to lower grade and provide positive drainage away from the building appears difficult to achieve. Accordingly, remove the timber joists and replace with slab on grade construction. Excavate the subgrade inside the building; install vapor barrier and 4" of stone prior to casting a 4" thick concrete slab. Install pressure treated furring strips and marine plywood subfloor in preparation of the placement of the finish flooring. Coordinate the requirements of HVAC and piping.*

### Second Floor

The second floor of the addition is framed with 3x8 joists at 16" centers. The allowable live load capacity of the framing, in general, is limited by the stiffness criteria to slightly less than 100 PSF. At the southern section of the addition a 3x8 trimmer spanning east-west has been dapped to accommodate the desired head clearance at the stairway. The resultant reduced section adversely affects the shear strength. Accordingly, the live load capacity of approximately 60 SF of floor is limited to less than 30 PSF.

*Remove portions of the plaster ceiling and reinforce the 3x8 trimmer with double 2x8 sisters connected with bolts to the south face of the existing member.*





## Roof

The roof is gable form and framed with 1 ½" x 5 ½" rafters at approximately 21" centers. The rafters are tied with the attic floor joists which are the same section but set at 16" centers. The attic floor joists bear on a 3x5 member (purlin orientation) that spans between the rafters. Although the framing arrangement is somewhat uncommon, the stability of the assembly is witnessed by a straight eave line and plumb second level walls.

In the northern section of the addition, the upper portions of the roof framing have been replaced. The char that can be observed on some of the members is witness to a fire, which probably started in the chimney located at the east end of the section. The subsequent repair of the roof structure involved removal of the damaged upper half of the roof including the ridge and then splicing on a replacement roof. The approach allowed the eave and attic section to remain



intact, which simplified the repair. Unfortunately, the method of splicing the rafters was poorly conceived. The damaged rafters were square cut and the ridge section of the roof removed. Then a 2x6 wood plate purlin was end nailed to the cut rafters. This provided a means for toenailing the replacement rafters that form the ridge of the roof. The connection has no bending strength and as a result has separated due to the tension at the bottom of the splice, causing noticeable sag in the member.

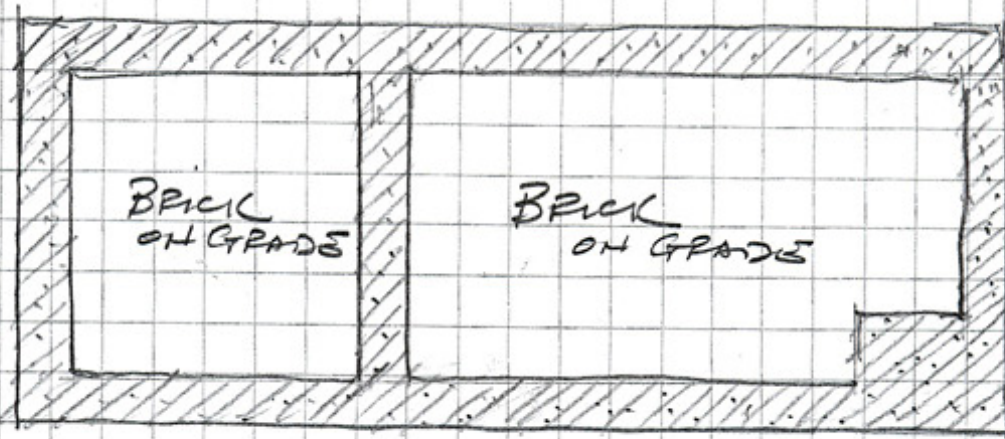
*Reinforce the splice with flat metal straps nailed to the bottom of each rafter. Cross sectional area of the strap and number of nails each side of the splice must address the tension and shear forces in the strap and the nails, respectively, when roof is loaded with snow.*

After you have the opportunity to review the findings and recommendations of this report, please call so that we might discuss how you plan to proceed with construction documentation for the recommended repairs.

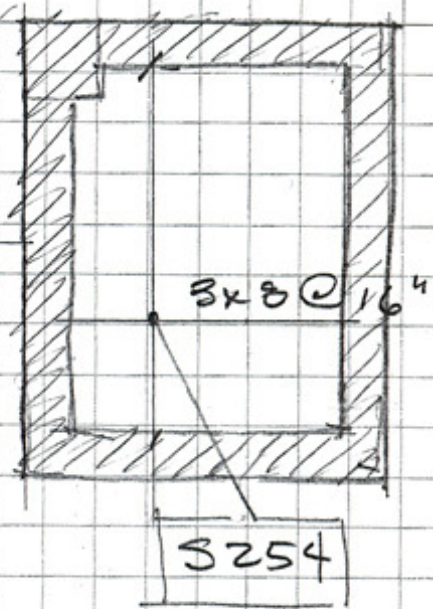
GREDELL & ASSOCIATES

Gary W. Gredell, P.E.

Enclosures: Engineers sketches sheets 1-3

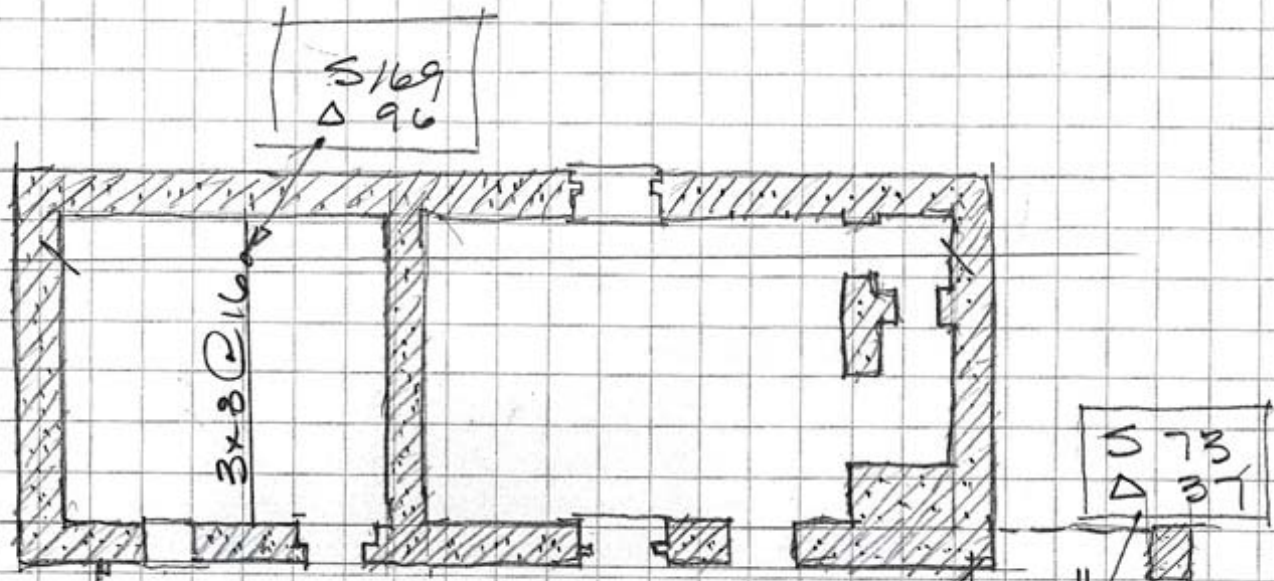


FIRST FLOOR FRAMING  
FOUNDATION PLAN  
1/8" = 1'-0"

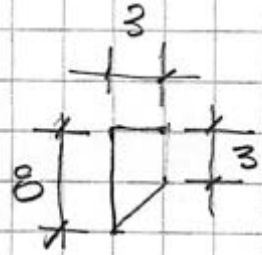


S ALLOWABLE LIVE LOAD PSF - STRENGTH





SECOND FLOOR FRAMING  
FIRST FLOOR PLAN  
 $\frac{1}{8}'' = 1'-0''$

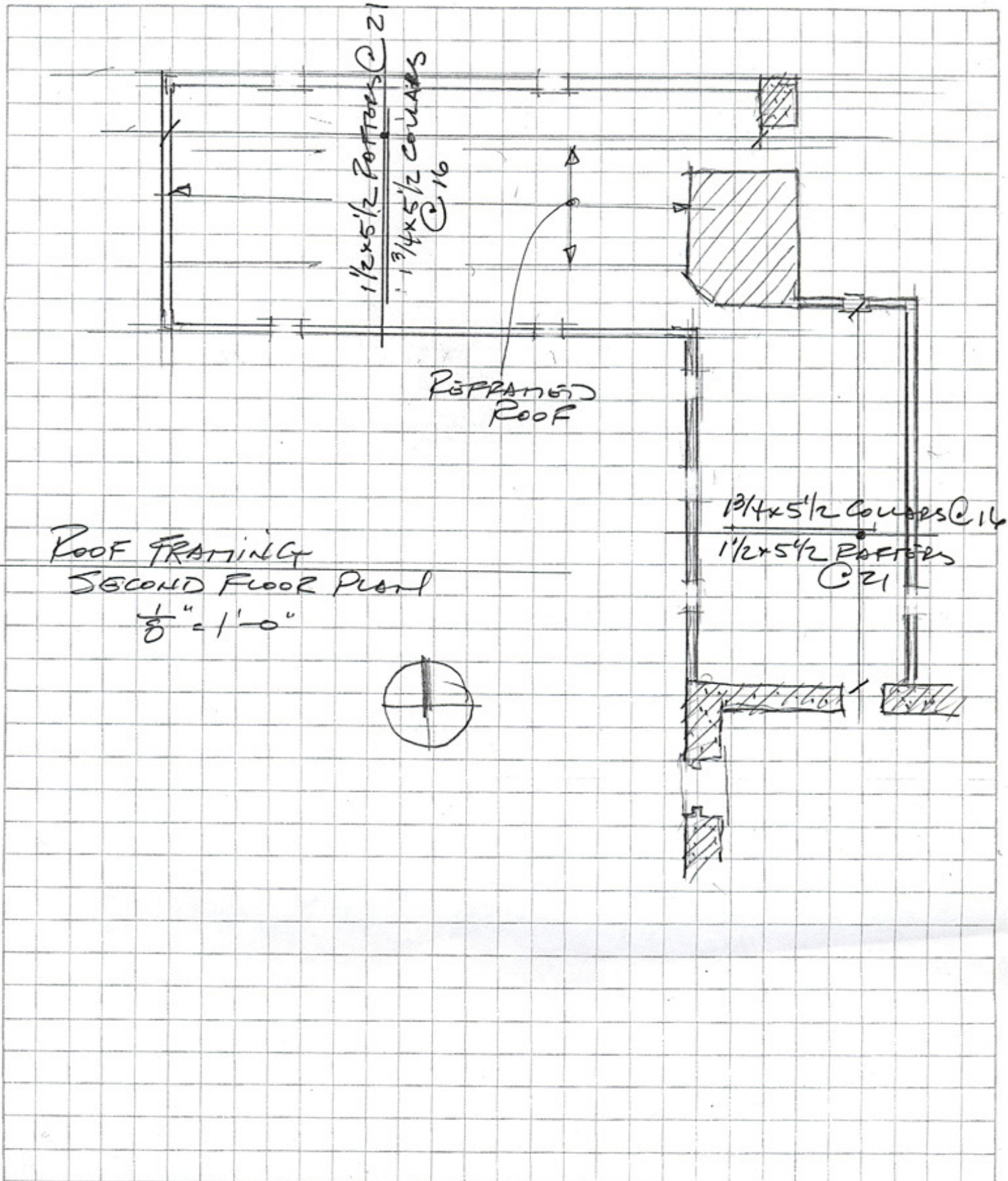


STAIR HEADER (A)

1830  
ADDITIONAL  
S 169  
Δ 96

S ALLOWABLE LIVE LOAD PSF - STRENGTH  
A " " PSF - DEFLECTION





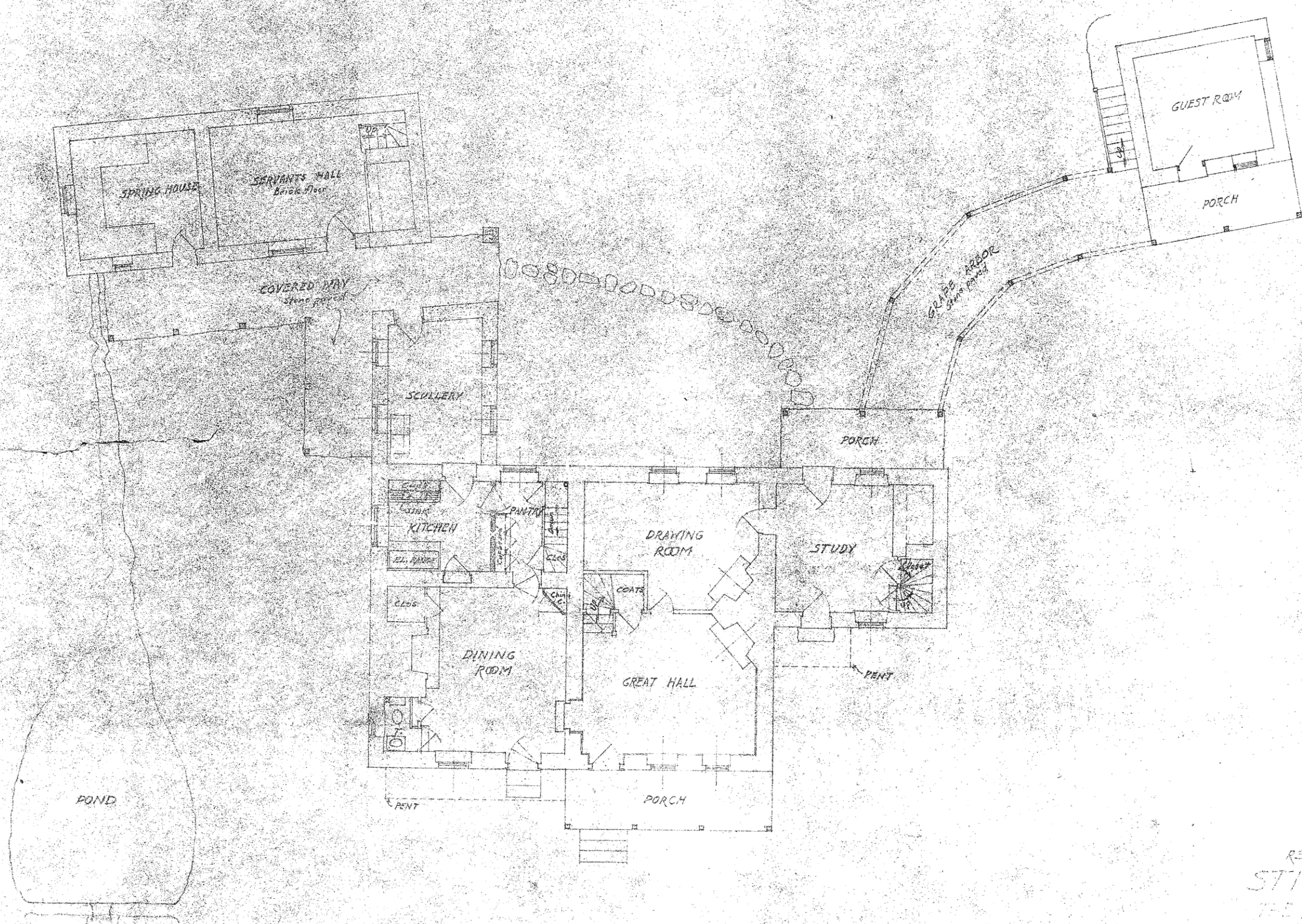
ROOF FRAMING  
SECOND FLOOR PLAN  
 $\frac{1}{8}'' = 1'-0''$



**APPENDIX E**  
**PRELIMINARY DRAWINGS**  
**OF 1926 RENOVATIONS -**  
**BOYLE IRWIN**







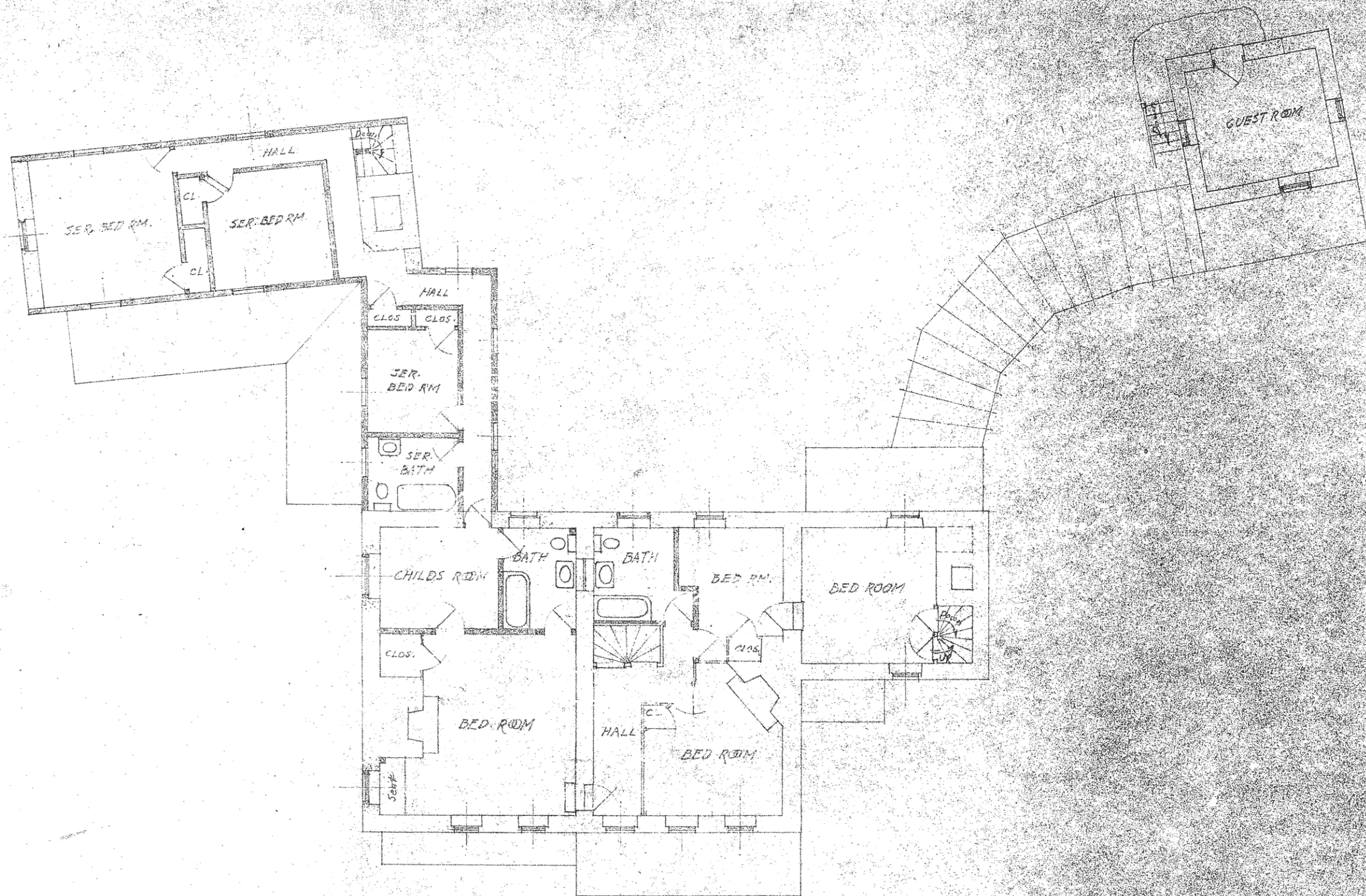
FIRST FLOOR PLAN

RESTORATION OF  
**STIRLING**  
 THE PROPERTY OF  
**ROBERT C. LISGET**  
 AT VALLEY FORGE, PA.

BOYLE IRWIN  
 RES. PROF. ENGR. & LAND SURV.  
 DATE 2-23-1936 DRAWING NO.  
 SCALE 1/8" = 1'-0" 244-01

DRAWING REPRODUCED  
 FROM A COPY OF THE ORIGINAL.  
 ORIGINAL DRAWING DELINEATED  
 BY BOYLE IRWIN, FEBRUARY 23, 1926.  
 COPY IN THE ARCHIVES OF  
 VALLEY FORGE NATIONAL  
 HISTORICAL PARK,  
 VALLEY FORGE, PA.  
 DRAWING NOT TO SCALE.





SECOND FLOOR PLAN

RESTORATION OF  
 STIRLING  
 THE PROPERTY OF  
 ROBERT C. LIGGETT  
 AT VALLEY FORGE, PA.

BOYLE IRWIN  
 REG. PROP. ENGR & LAND SURV.  
 DATE 2-28-1926  
 SCALE 1/8" = 1' FOOT  
 DRAWING NO.  
 244-02

DRAWING REPRODUCED FROM A COPY OF THE ORIGINAL.

ORIGINAL DRAWING DELINEATED BY BOYLE IRWIN, FEBRUARY 23, 1926.

COPY IN THE ARCHIVES OF VALLEY FORGE NATIONAL HISTORICAL PARK, VALLEY FORGE, PA.

DRAWING NOT TO SCALE.



FRONT ASPECT

SOUTH

RESTORATION OF  
STIRLING  
THE PROPERTY OF  
ROBERT C. LIGGET  
AT VALLEY FORGE, PA

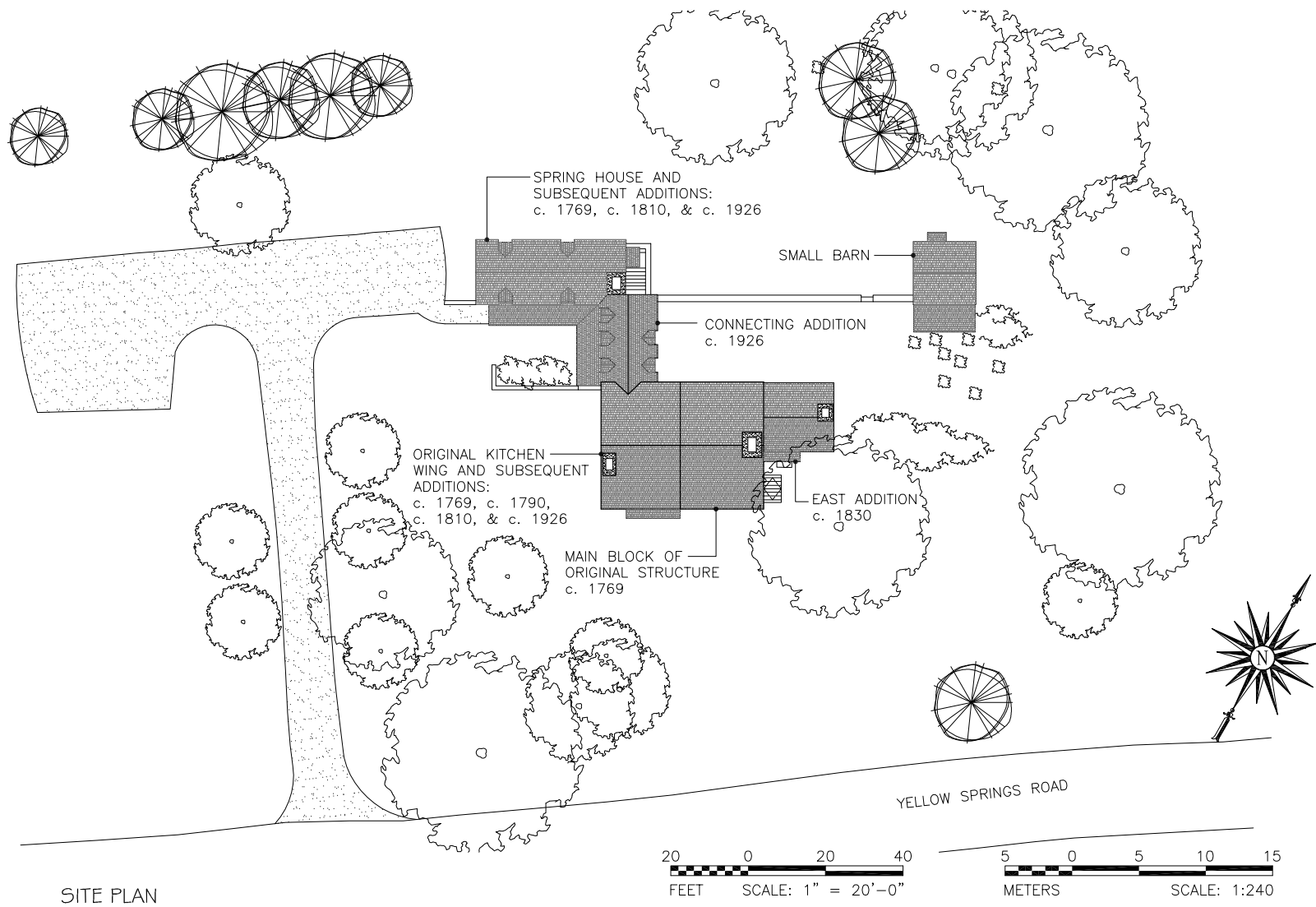
BOYLE IRWIN  
REG. PROF. ENGR. & LAND SURV.  
DATE 2-23-1926 DRAWING NO.  
SCALE 1/8" = 1' 244-03

DRAWING REPRODUCED  
FROM A COPY OF THE ORIGINAL.  
ORIGINAL DRAWING DELINEATED  
BY BOYLE IRWIN, FEBRUARY 23, 1926.  
COPY IN THE ARCHIVES OF  
VALLEY FORGE NATIONAL  
HISTORICAL PARK,  
VALLEY FORGE, PA.  
DRAWING NOT TO SCALE.

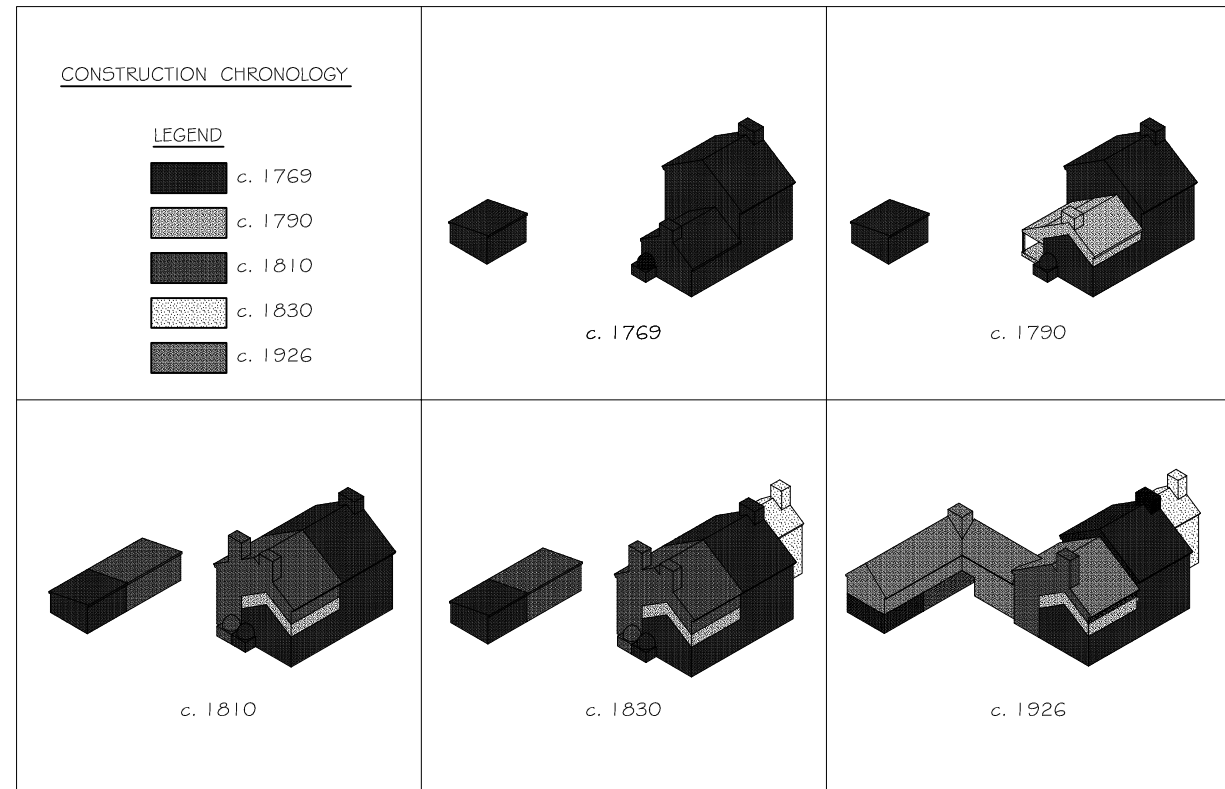
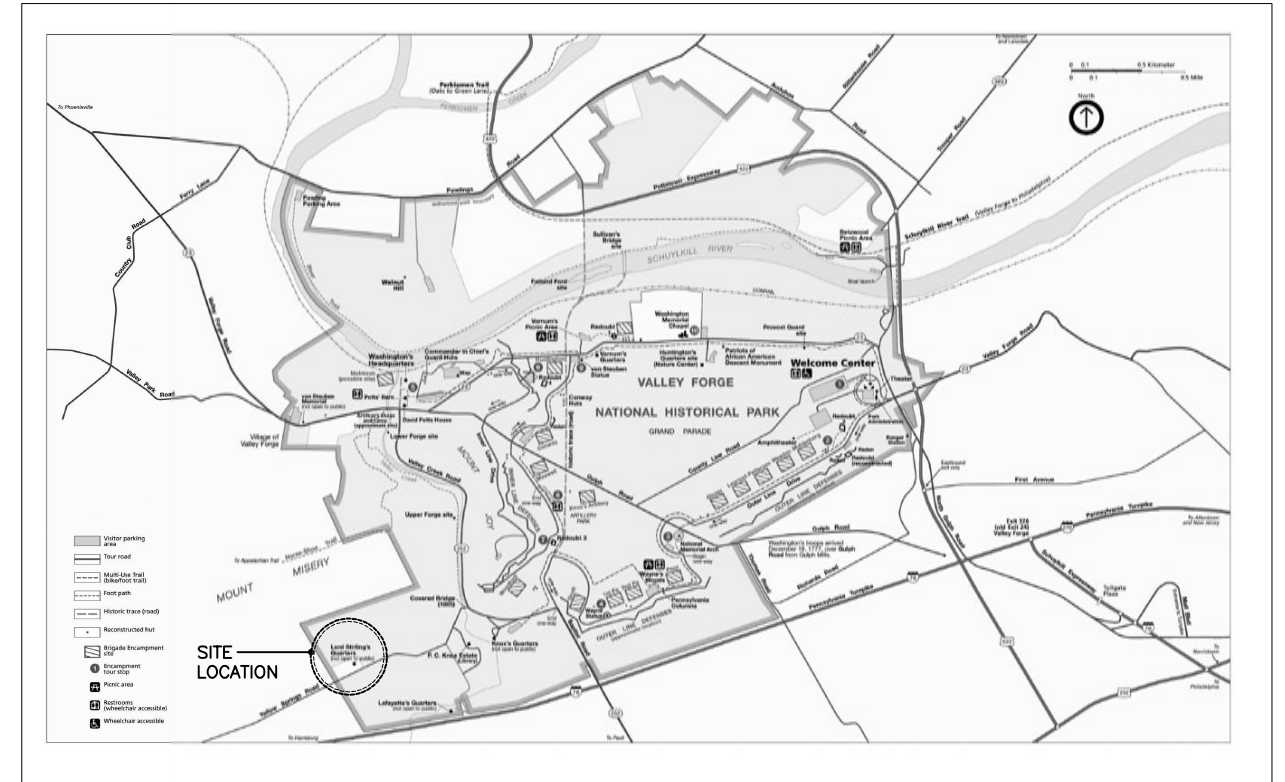
**APPENDIX F**  
**HISTORIC AMERICAN**  
**BUILDINGS SURVEY (HABS)**  
**DRAWINGS**







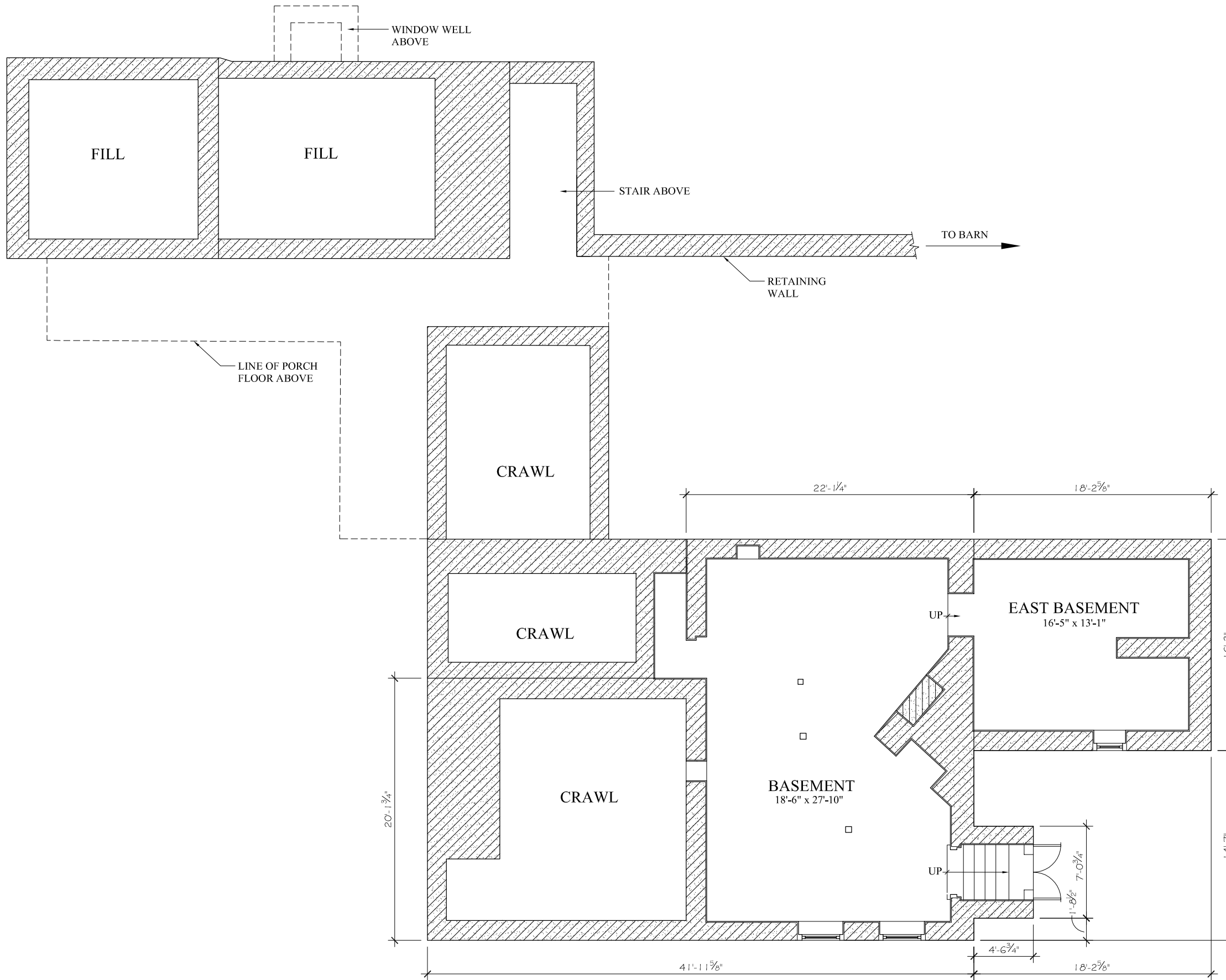
SITE PLAN



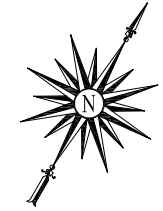
# STIRLING'S QUARTERS

## VALLEY FORGE NATIONAL HISTORICAL PARK

STIRLING'S QUARTERS, AS THE PROPERTY IS CURRENTLY KNOWN, IS NAMED FOR ONE OF GEORGE WASHINGTON'S MOST DISTINGUISHED CONTINENTAL ARMY OFFICERS, MAJOR GENERAL WILLIAM ALEXANDER, LORD STIRLING (1726-1883), WHO IS REPUTED TO HAVE OCCUPIED THE HOUSE AND FARMSTEAD AT THE TIME OF THE VALLEY FORGE ENCAMPMENT. THE SIGNIFICANCE OF THE PROPERTY IS DUE IN MOST PART TO STIRLING'S SUPPOSED OCCUPATION OF THE HOUSE AND THE EVENTS THAT TOOK PLACE DURING THAT LEGENDARY WINTER OF 1777-1778. JAMES MONROE (1758-1831), WHO LATER BECAME THE FIFTH PRESIDENT OF THE UNITED STATES, JOINED STIRLING'S STAFF AS AIDE-DE-CAMP IN NOVEMBER 1777 AND MAY ALSO HAVE OCCUPIED THE HOUSE DURING THE ARMY'S ENCAMPMENT AT VALLEY FORGE. THE PROPERTY IS ALSO SIGNIFICANT AS THE FORMER RESIDENCE OF THE REVEREND WILLIAM CURRIE (1710-1803), MISSIONARY MINISTER OF THE CHURCH OF ENGLAND TO THE PARISHES OF ST. DAVID'S IN RADNOR, ST. PETER'S IN THE GREAT VALLEY, AND ST. JAMES' IN PERKIOMEN FROM 1737-1776.



BASEMENT FLOOR PLAN



DRAWN BY: JOHN MILNER ARCHITECTS, INC. JANUARY 2006 (DRAFT)

NATIONAL PARK SERVICE  
U.S. DEPARTMENT OF THE INTERIOR

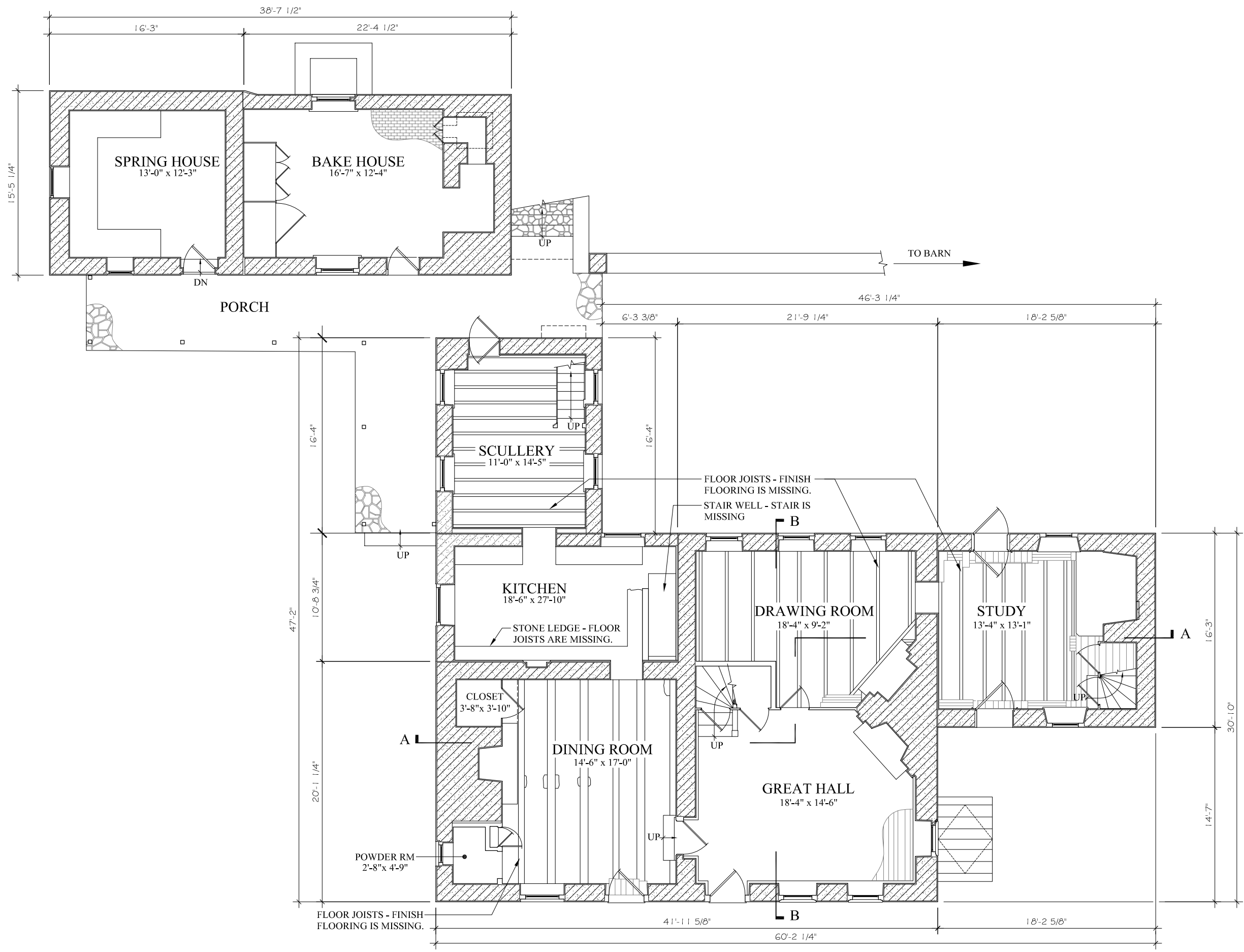
STIRLING'S QUARTERS

VALLEY FORGE NATIONAL HISTORICAL PARK · 555 YELLOW SPRINGS ROAD · TREDYFFRIN TOWNSHIP · CHESTER COUNTY · PENNSYLVANIA

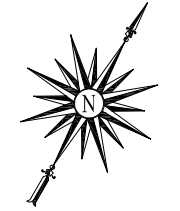
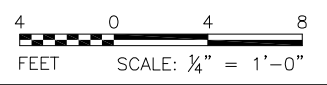
SURVEY NO. PA-6720

HISTORIC AMERICAN BUILDINGS SURVEY  
SHEET 2 OF 10 SHEETS

DATE OF SURVEY  
1982



FIRST FLOOR PLAN



DRAWN BY: JOHN MILNER ARCHITECTS, INC. JANUARY 2006 (DRAFT)

NATIONAL PARK SERVICE  
U.S. DEPARTMENT OF THE INTERIOR

STIRLING'S QUARTERS

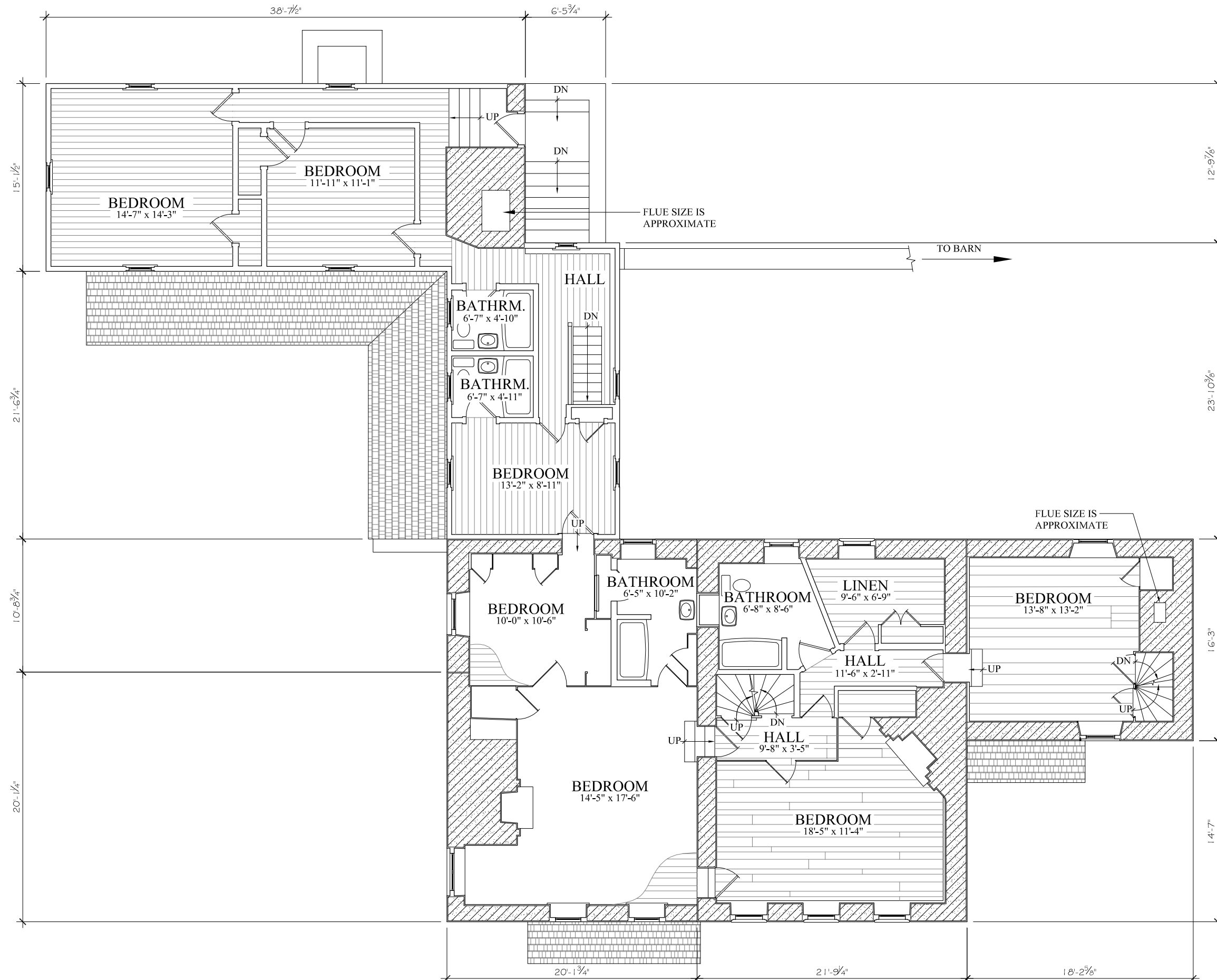
VALLEY Forge NATIONAL HISTORICAL PARK • 555 YELLOW SPRINGS ROAD • TREDYFFRIN TOWNSHIP • CHESTER COUNTY • PENNSYLVANIA

SURVEY NO. PA-6720

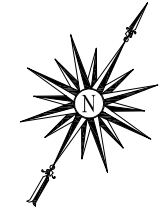
HISTORIC AMERICAN BUILDINGS SURVEY SHEET 3 OF 10 SHEETS

DATE OF SURVEY: 1982





SECOND FLOOR PLAN



DRAWN BY: JOHN MILNER ARCHITECTS, INC. JANUARY 2006 (DRAFT)

NATIONAL PARK SERVICE  
U.S. DEPARTMENT OF THE INTERIOR

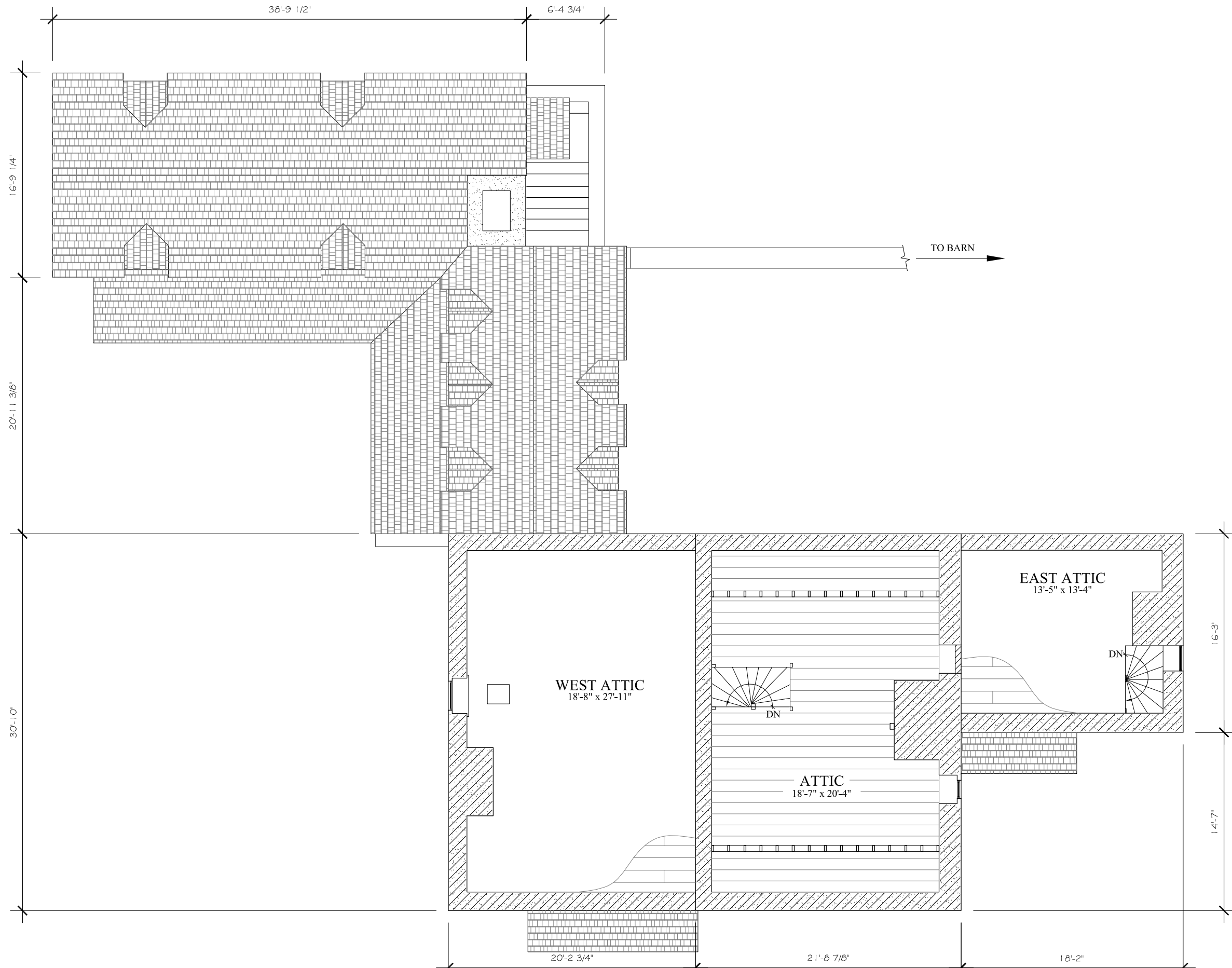
STIRLING'S QUARTERS

VALLEY Forge NATIONAL HISTORICAL PARK • 555 YELLOW SPRINGS ROAD • TREDYFFRIN TOWNSHIP • CHESTER COUNTY • PENNSYLVANIA

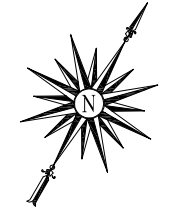
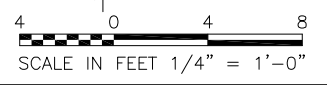
SURVEY NO. PA-6720

HISTORIC AMERICAN BUILDINGS SURVEY  
SHEET 4 OF 10 SHEETS

DATE OF SURVEY  
1987



ATTIC PLAN



DRAWN BY: JOHN MILNER ARCHITECTS, INC. JANUARY 2006 (DRAFT)

NATIONAL PARK SERVICE  
U.S. DEPARTMENT OF THE INTERIOR

**STIRLING'S QUARTERS**

VALLEY FORGE NATIONAL HISTORICAL PARK · 555 YELLOW SPRINGS ROAD · TREDYFFRIN TOWNSHIP · CHESTER COUNTY · PENNSYLVANIA

SURVEY NO.  
PA-6720

HISTORIC AMERICAN  
BUILDINGS SURVEY  
SHEET 5 OF 10 SHEETS

DATE OF SURVEY  
2006



SOUTH ELEVATION



WEST ELEVATION



DRAWN BY: JOHN MILNER ARCHITECTS, INC. JANUARY 2006 (DRAFT)

NATIONAL PARK SERVICE  
U.S. DEPARTMENT OF THE INTERIOR

STIRLING'S QUARTERS

VALLEY Forge NATIONAL HISTORICAL PARK • 555 YELLOW SPRINGS ROAD • TREDYFFRIN TOWNSHIP • CHESTER COUNTY • PENNSYLVANIA PA-6720

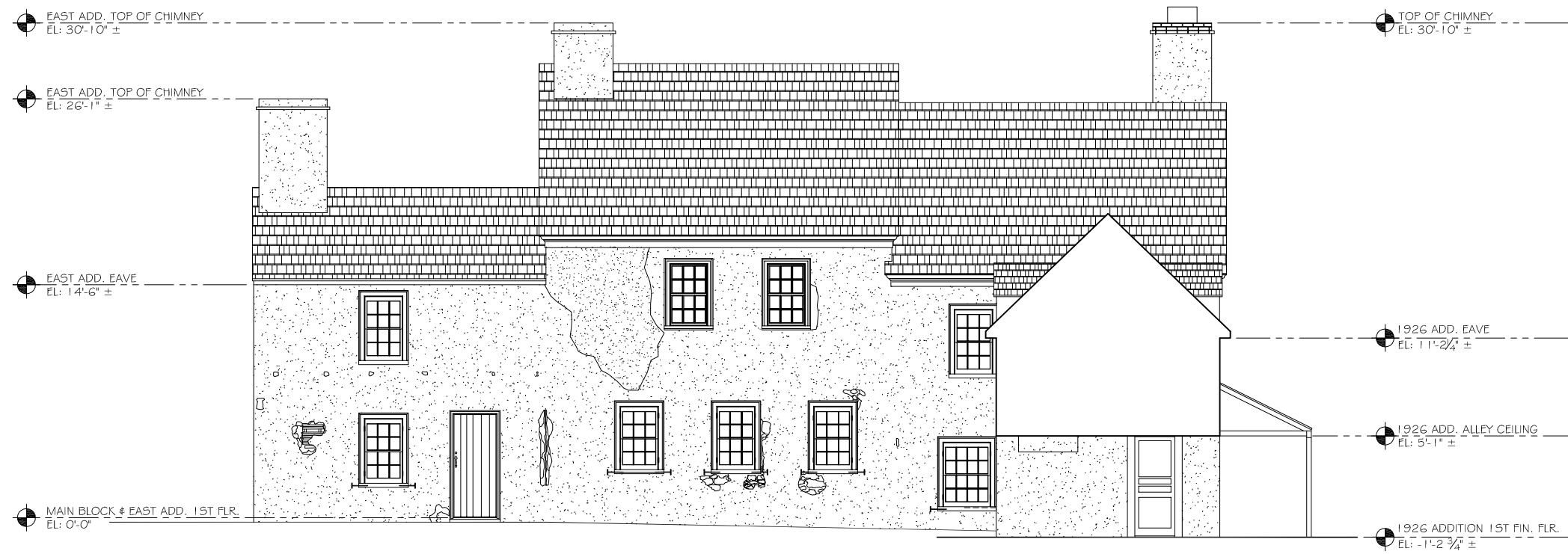
SURVEY NO.

PA-6720

HISTORIC AMERICAN  
BUILDINGS SURVEY

SHEET 6 OF 10 SHEETS

UNIVERSITY OF CHICAGO  
PRESS

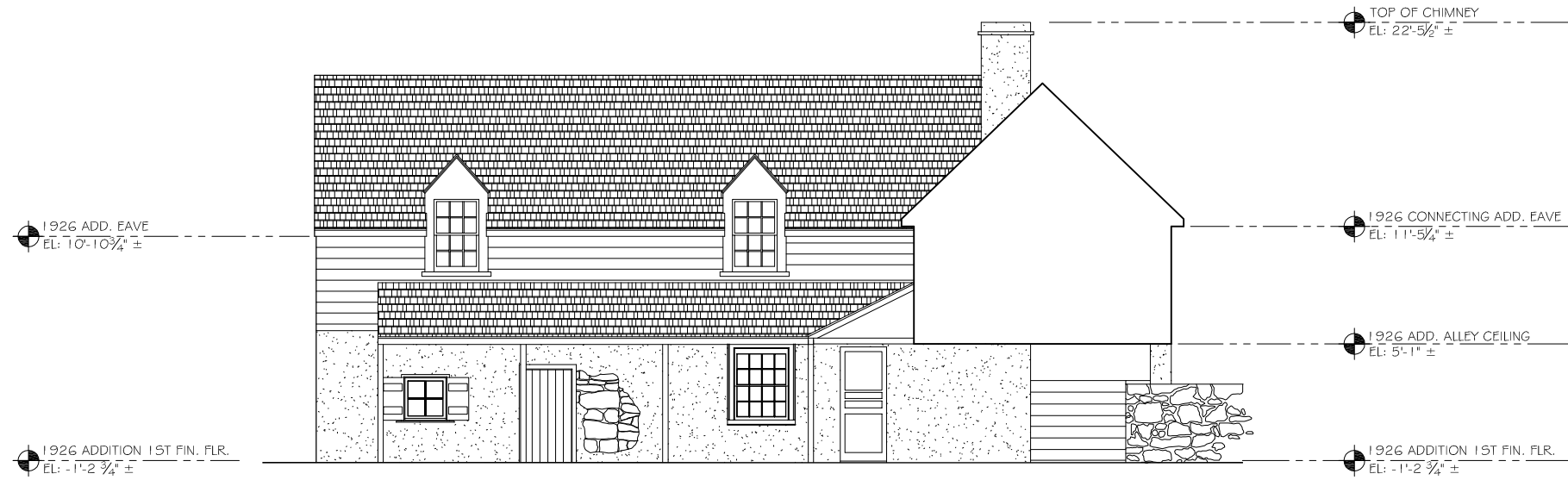


NORTH ELEVATION

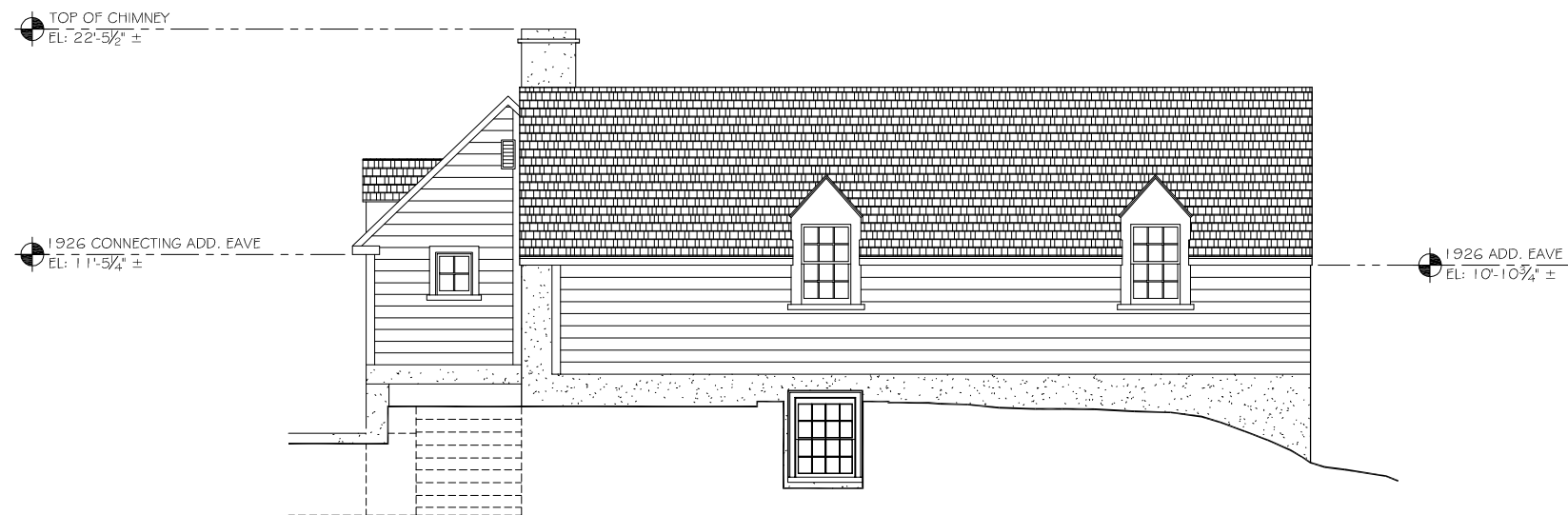


EAST ELEVATION



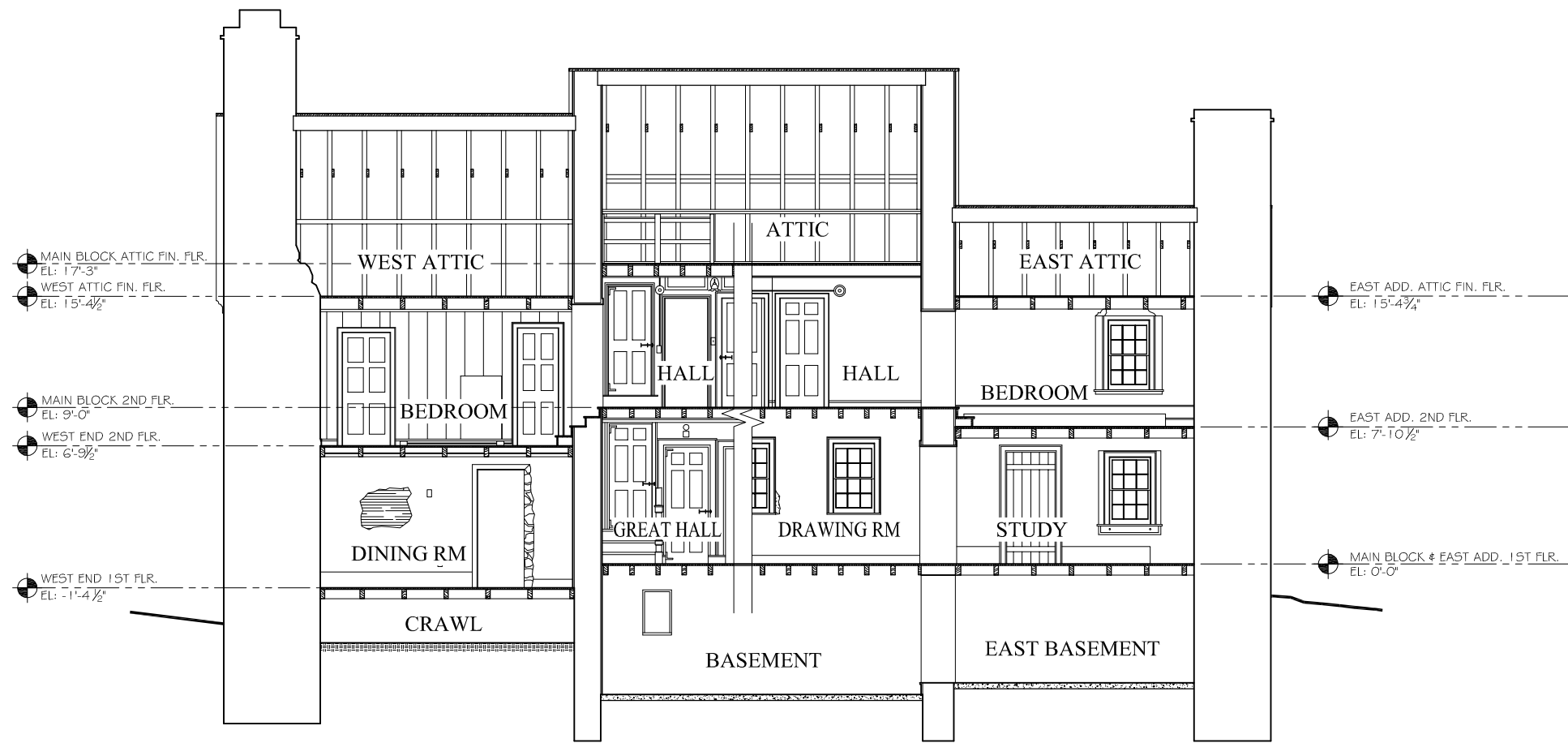


SPRINGHOUSE - SOUTH ELEVATION

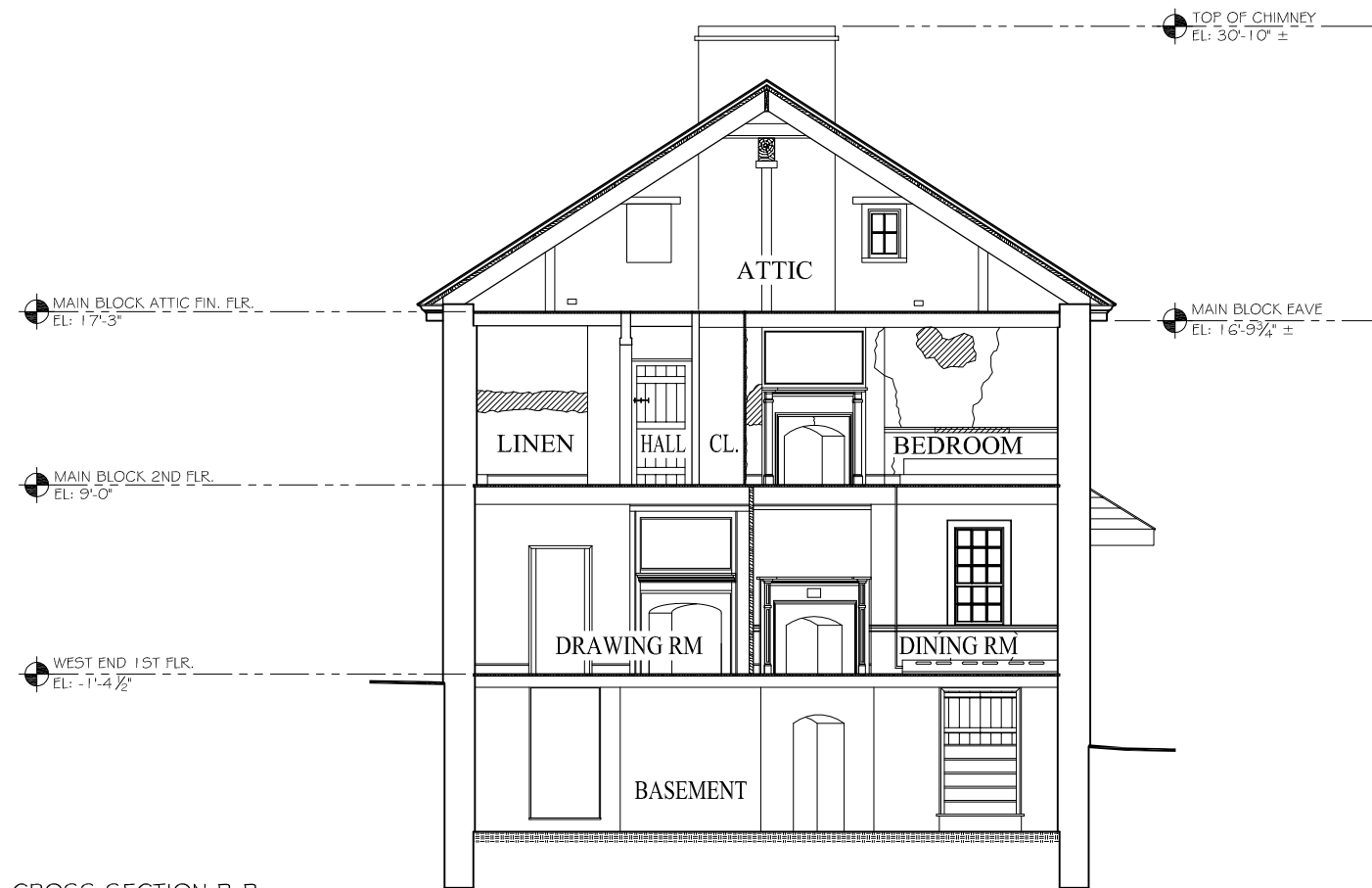


SPRINGHOUSE - NORTH ELEVATION





LONGITUDINAL SECTION A-A



CROSS SECTION B-B

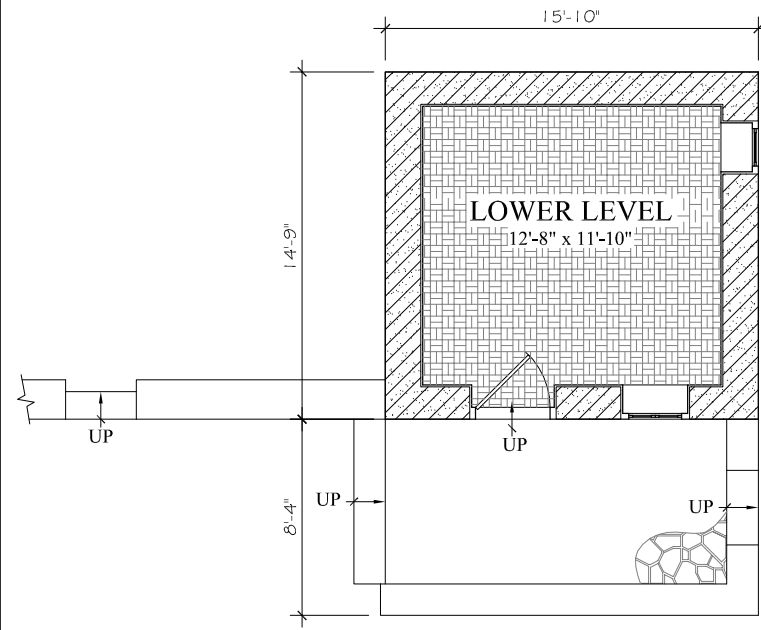




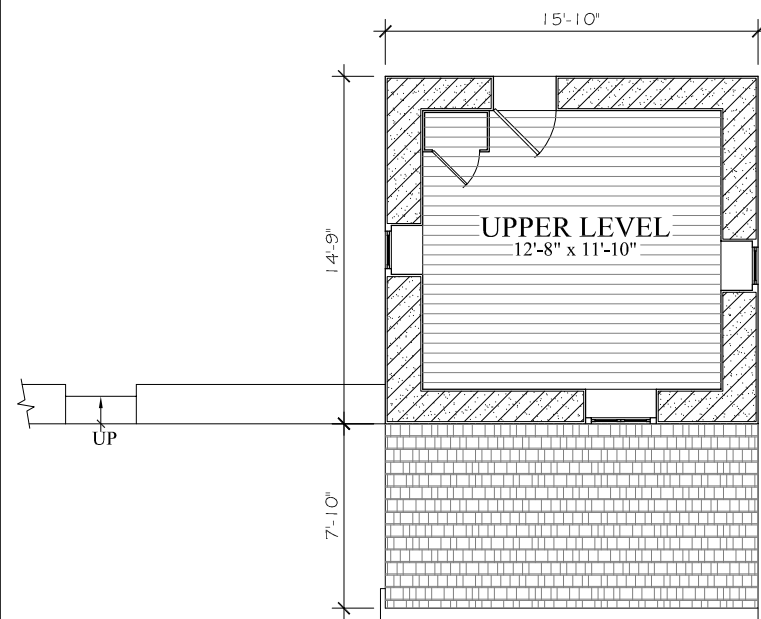
# STIRLING'S QUARTERS

## VALLEY FORGE NATIONAL HISTORICAL PARK

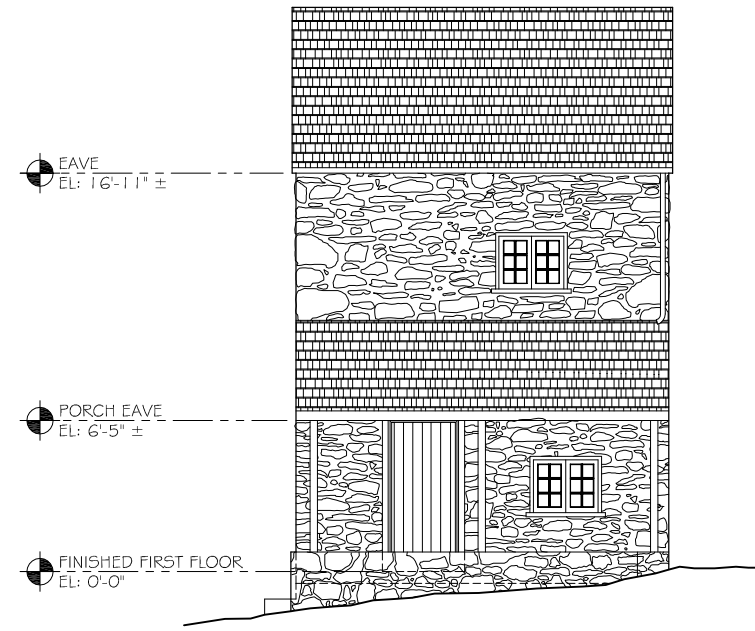
### SMALL BARN



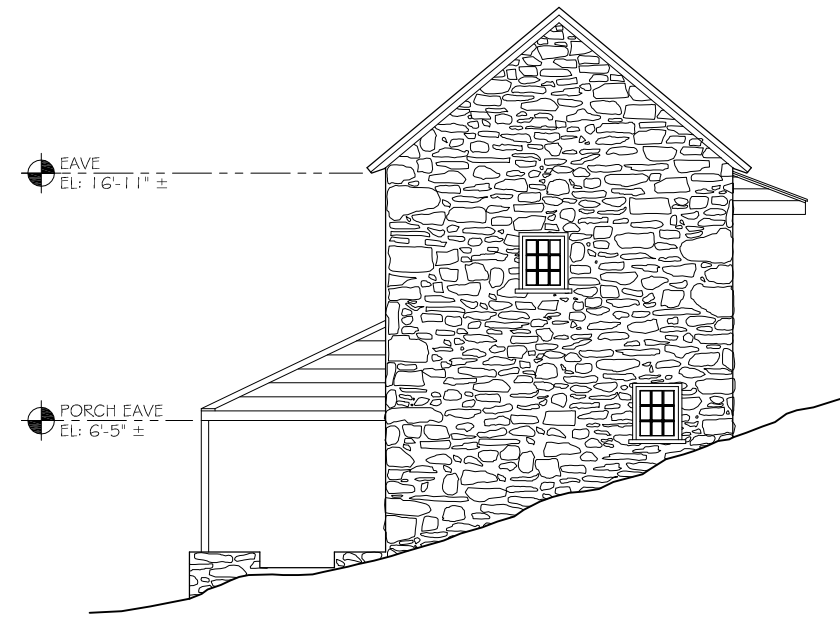
FIRST FLOOR PLAN



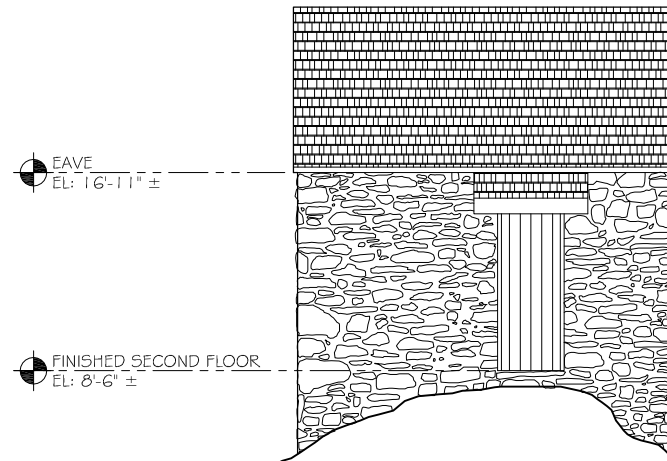
SECOND FLOOR PLAN



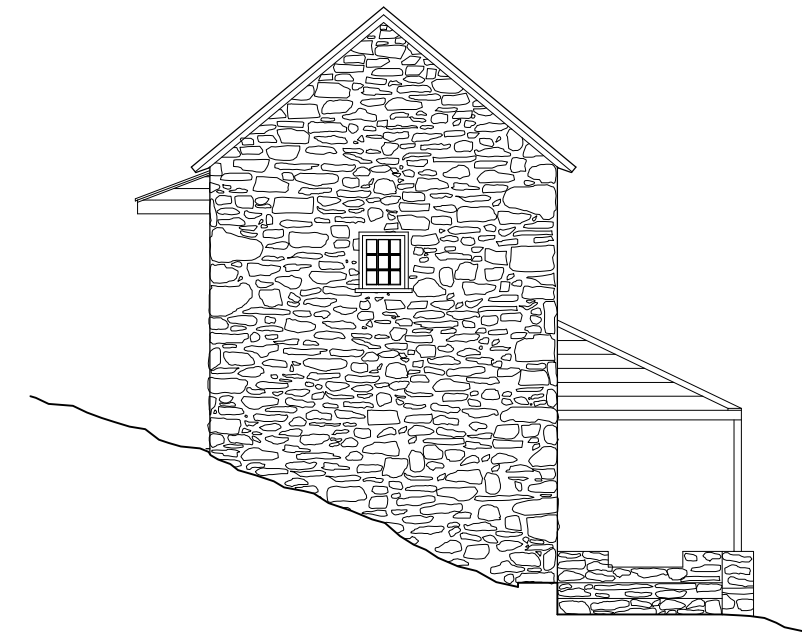
SOUTH ELEVATION



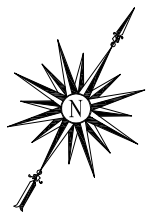
EAST ELEVATION



NORTH ELEVATION



WEST ELEVATION



DRAWN BY: JOHN MILNER ARCHITECTS, INC. JANUARY 2006 (DRAFT)

NATIONAL PARK SERVICE  
U.S. DEPARTMENT OF THE INTERIOR

STIRLING'S QUARTERS  
VALLEY FORGE NATIONAL HISTORICAL PARK · 555 YELLOW SPRINGS ROAD · TREDYFFRIN TOWNSHIP · CHESTER COUNTY · PENNSYLVANIA

SURVEY NO.  
PA-6720

HISTORIC AMERICAN  
BUILDINGS SURVEY  
SHEET 10 OF 10 SHEETS

DATE: 01/06

**APPENDIX G**  
**SELECTED ARCHIVE**  
**PHOTOGRAPHS**





**Archive Photo 1**  
Corner stones with inscribed initials and dates at southeast corner of west block.

Repository:	Valley Forge National Historical Park Archives
Negative Number:	VAFO 6373
Photographer:	Ken Block
Date:	April 1984





**Archive Photo 2**  
Postcard - "Lord Stirling's  
Headquarters, Valley Forge, Pa."

Repository:	Valley Forge National Historical Park Archives
Negative Number:	VAFO 63648 (Negative 3289)
Photographer:	Unknown
Date:	c. 1900

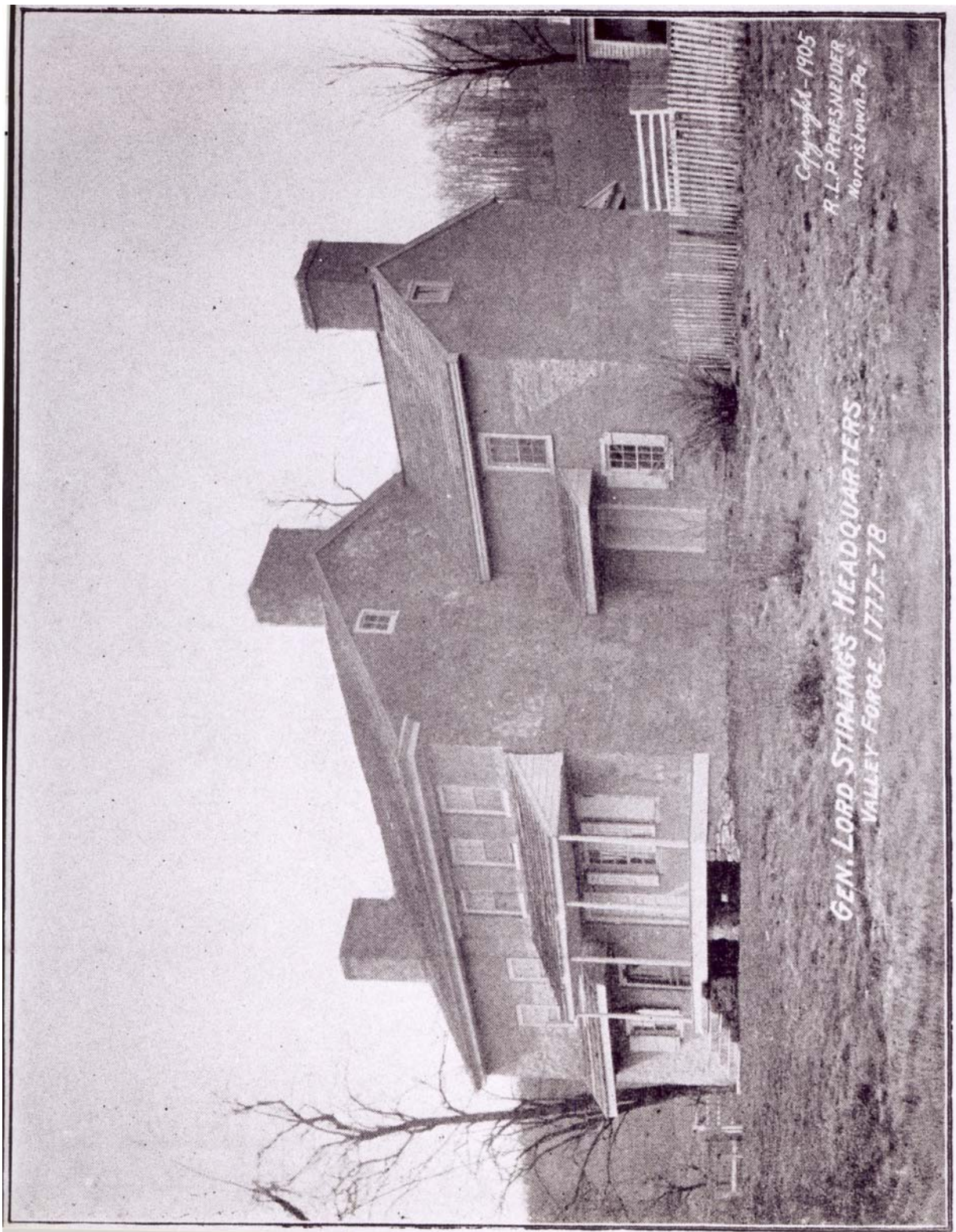




**Archive Photo 3**  
Oblique view of main house,  
looking northeast.

Repository:	Valley Forge National Historical Park Archives
Negative Number:	VAFO 63644 (Negative 9001)
Photographer:	Unknown
Date:	April 1902

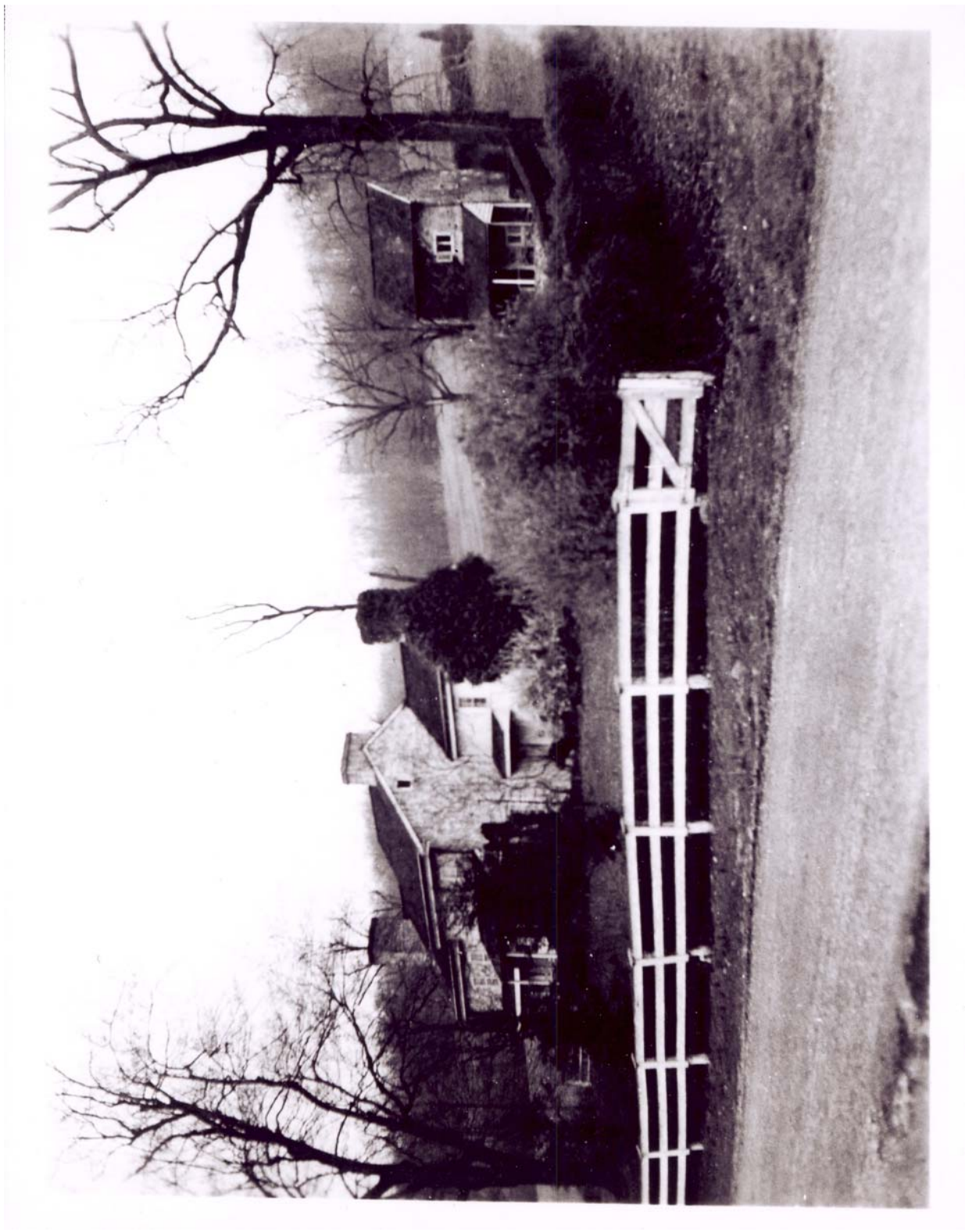




**Archive Photo 4**  
Oblique view of main house,  
looking northwest.

Repository:	Valley Forge National Historical Park Archives
Negative Number:	VAFO 63647 (Negative 3291)
Photographer:	R. L. P. Reifsneider
Date:	1905

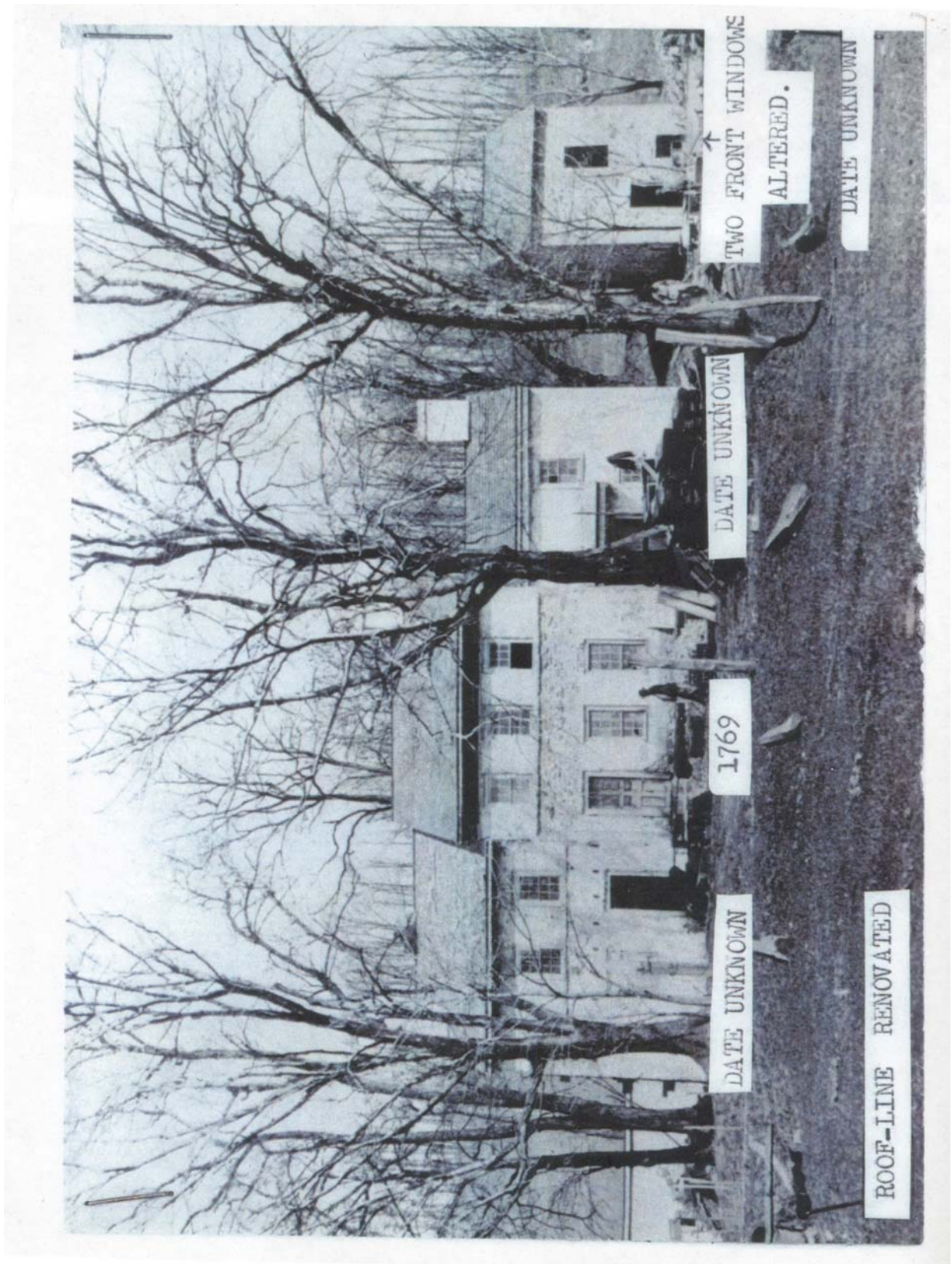




**Archive Photo 5**  
Oblique view of main house and  
small barn, looking northwest.

Repository:	Valley Forge National Historical Park Archives
Negative Number:	VAFO 61987 (Negative 3167)
Photographer:	Unknown
Date:	c. 1945





**Archive Photo 6**  
 South elevation of main house  
 and small barn, looking north.  
 (Captions are attached to photo.)

Repository:	Valley Forge National Historical Park Archives
Negative Number:	VAFO 6185
Photographer:	Unknown
Date:	c. 1926





**Archive Photo 7**  
West elevation of main house,  
small barn, and springhouse,  
looking north.

Repository:	Valley Forge National Historical Park Archives
Negative Number:	VAFO 6186
Photographer:	Unknown
Date:	c. 1925

